

# Frizioni e Bandelle freno

*EMBAYAGES ET BANDES FRAIN  
CLUTCHES AND BRAKE BELTS  
KUPPLUNGEN UND BREMSBÄNDER  
EMBRAGUES Y BANDAS FRENO*



Ricambi macchine agricole e giardinaggio

[www.cermag.com](http://www.cermag.com)

# Frizioni e loro componenti

CLUTCHES - CLUTCH DISK - BEARING - COUPLING - LEVER - SET-REVISION

11

## KIT LUK PER IL MONTAGGIO E CENTRAGGIO DELLA FRIZIONE DEI TRATTORI

JEU LUK POUR L'ENSEMBLE ET LE CENTRAGE DES EMBRAYAGES DU TRACTEURS

LUK KIT FOR MOUNTING AND ALIGNING OF TRACTORS' CLUTCHES

KIT ZUR KUPPLUNGS AUSRICHT. LUK

KIT LUK PARA EL MONTAJE Y CENTRADO DE LOS EMBRAGUES DE TRACTORES



### CARATTERISTICHE

Innovativo kit per il centraggio della frizione in grado di essere utilizzato con tutte le principali dimensioni del mozzo del cuscinetto.

L'attrezzo garantisce montaggi veloci ed accurati riducendo il rischio di danni durante lo svolgimento della riparazione.

Il kit è adatto ad essere utilizzato su trattori CNH, John Deere, Landini, Massey Ferguson, SDF e altri marchi.

Il kit completo include 32 centratori volano e 11 centratori disco.







**Centratori volano: 14mm fino a 45mm**

**Centratori disco: 12mm, 14mm, 15mm, 16mm, 17mm, 20mm, 22mm, 25mm, 30mm, 36mm, 40mm**



ARTICOLO	DESCRIZIONE
16108	Valigetta kit montaggio frizioni composta da: Centratori volano da 14mm fino a 45mm Centratori disco da 12mm, 14mm, 15mm, 16mm, 17mm, 20mm, 22mm, 25mm, 30mm, 36mm e 40mm















## ADRIATICA MACCHINE

MOTAZAPPE E MOTOCOLIVATORI (DAL 1993 IN AVANTI)	 <b>Art. 15519</b>	OEM Frizione conica Ø 103x90 mm Albero Ø 23 mm Conicità 1:5 14x11x3 mm - Z.6		
MOTOCOLTIVATORI 10 HP (DAL 1993 IN AVANTI)	 <b>Art. 15521</b>	OEM Frizione Ø 103x90 mm a dischi multipli con 4 dischi 14x11x3 mm - Z.6 Albero Ø23 mm		
MOTOCOLTIVATORI 12 HP (DAL 1994 IN AVANTI)	 <b>Art. 15620</b>	OEM Frizione Ø 103x90 mm a dischi multipli con 4 dischi 14x11x3 mm - Z.6 Albero Ø23 filettato		
MINIMEC SUPERMEC 14 HP  (segue ADRIATICA MACCHINE)	 <b>Art. 15354</b>	OEM Frizione monodisco a molle elicoidali Piatto Ø 140 mm	 <b>Art. 15020</b>	OEM Disco frizione rigido 140x96x3,8 mm 17x15EV Z.20
			 <b>Art. 15044</b>	OEM Manicotto con anello in grafite

# Frizioni e loro componenti

CLUTCHES - CLUTCH DISK - BEARING - COUPLING - LEVER - SET-REVISION





## segue ADRIATICA MACCHINE

SUPERMEC 18 HP	<b>Art. 15016</b>  OEM Frizione monodisco a molle elicoidali Piatto Ø 155 mm	<b>Art. 15198</b>  OEM Disco frizione rigido 155x114x4 mm 17x15EV Z.20	<b>Art. 15051</b>  OEM Cuscinetto Reggispinta
		<b>Art. 15359</b>  OEM Manicotto completo di molla	
MASTERMEC L2 - R2 - S2 - L30 MOTOAGRICOLA MAJORMEC (1ª SERIE)	<b>Art. 15012</b>  OEM Frizione monodisco con molle a diaframma Piatto Ø 180 mm	<b>Art. 15031</b>  OEM Disco frizione rigido 181x127x3,8 mm 23x20EV Z.20	<b>Art. 15043</b>  OEM Manicotto con cuscinetto reggispinta
TRATTORINO 845	<b>Art. 15515</b>  OEM Frizione monodisco con molle a diaframma Piatto Ø 215 mm	<b>Art. 15099</b>  OEM Disco frizione rigido 215x152x3,8 mm 23x20EV Z.20	<b>Art. 15043</b>  OEM Manicotto con cuscinetto reggispinta
MOTOZAPPA MINIFALCE	<b>Art. 15710</b>  OEM Frizione conica Ø 103x82,5 mm Albero Ø 23 Conicità 1:5 11x14x3 - Z.6		
MASTERMEC L2 - R2 - S2 - L30 MOTOAGRICOLA MAJORMEC (2ª SERIE)	<b>Art. 15711</b>  OEM Frizione monodisco con molle a diaframma Piatto Ø 180 mm	<b>Art. 15031</b>  OEM Disco frizione rigido 181x127x3,8 mm 23x20EV Z.20	<b>Art. 15043</b>  OEM Manicotto con cuscinetto reggispinta

## AEBI

TP 25/35/45S/50	<b>Art. Kit 16084</b>     OEM 707487 - 787514R91 Kit completo Ø 230 con disco PTO Ø 225 Z.15 e cuscinetto 41,6x76,62x24		
-----------------	---	--	--

## AGRIFULL RUOTE

TRATTORI 68-78 E DERIVATI	<b>Art. 15149</b>  OEM Frizione monodisco a molle elicoidali Piatto Ø 215 mm	<b>Art. 15325</b>  OEM Disco frizione rigido 216x152x3,8 mm 26x21x4 Z.10	<b>Art. 15055</b>  OEM Cuscinetto Reggispinta
		<b>Art. 15049</b>  OEM Manicotto	

























(segue AGRIFULL RUOTE)

# Frizioni e loro componenti

CLUTCHES - CLUTCH DISK - BEARING - COUPLING - LEVER - SET-REVISION

11

## segue AGRIFULL RUOTE

<p>JOLLY 50 TOSELLI 60-70-85 DERBY 60-80 GRISO 70-75 TORNADO 80 8045 - 8050 - 8055 8060 - 55.46 - 65.46 RODEO 90 - 90</p> <p>1ª serie - Fino al 1976</p>	<p><b>Art. Kit 15976</b></p>  	<p>OEM 87689657 Kit composto da: - Meccanismo 15544 - Disco PTO 15943 - Cuscinetti 15990 - 63896 - 63867</p>		
	<p><b>Art. 15544</b></p> 	<p>OEM 5145706 - 5154879 - 5171137 - Meccanismo a 6 leve completo di disco centrale in ferodo senza il disco PTO. - Piatto Ø 280 mm (11")</p>	<p><b>Art. 15943</b></p> 	<p>OEM 5145715 - 5154703 Disco PTO rigido in ferodo 280x165x3 mm 25x22EV - Z.10</p>
	<p><b>Art. 15147</b></p> 	<p>OEM 5171053 - 5155304 Disco centrale in ferodo con molle parastrappi 280x165x4.4 mm 40x35EV - Z.14</p>	<p><b>Art. 15990</b></p> 	<p>OEM 5119290 5119875 - 5122028 Cuscinetto reggispinta cambio 90x50x22 mm</p>
	<p><b>Art. 16167</b></p> 	<p>OEM 4993817 Collare</p>	<p><b>Art. 62951</b></p> 	<p>OEM 24905360 - 84455696 Cuscinetto reggispinta PTO 70x110x20 mm</p>
<p>JOLLY 50 TOSELLI 60-70-85 DERBY 60-80 GRISO 70-75 TORNADO 80 8045 - 8050 - 8055 8060 - 8075 RODEO 90 - 90 55.46 - 65.46 RODEO 90 - 90 60II - 70II - 80II - 466 - 450S - 480 - 500 - 530 - 540 - 566 - 570 - 580 - 600 - 640 - 666 - 670</p> <p>2ª serie - Rinforzata</p> <p><b>MECCANISMO RINFORZATO</b></p> <p>N.B.: Quando si sostituisce un meccanismo non rinforzato con un meccanismo rinforzato, bisogna sostituire anche il disco PTO.</p>	<p><b>Art. Kit 15929</b></p>  	<p>OEM Kit composto da: - Meccanismo 15505 - Disco PTO 15943</p>		
	<p><b>Art. Kit 15938</b></p>  	<p>OEM Kit composto da: - Meccanismo 15505 - Disco PTO 15943 - Cuscinetti 15990 - 63896 - 63867</p>		
	<p><b>Art. 15505</b></p> 	<p>OEM 5162900-5150652 Meccanismo a 6 leve completo di disco centrale metalceramico a 6 pale senza il disco PTO. Piatto Ø 280 mm (11") Intercambiabile con meccanismo VALEO</p>	<p><b>Art. 15943</b></p> 	<p>OEM 5145715 - 5154703 Disco PTO rigido in ferodo 280x165x3 mm 25x22EV - Z.10</p>
	<p><b>Art. 15414</b></p> 	<p>OEM 5145711 Disco centrale metalceramico a 5 pale con molle parastrappi Ø 280 mm sinterizzato 40x35EV - Z.14</p> <p><b>Tipo SILA intercambiabile con LUK</b></p>	<p><b>Art. 15528</b></p> 	<p>OEM 5162901 Disco centrale metalceramico a 6 pale con molle parastrappi per meccanismo 15505 Ø 280 mm sinterizzato 40x35EV - Z.14</p>
	<p><b>Art. 15990</b></p> 	<p>OEM 5119290 5119875 - 5122028 - 87345759 Cuscinetto reggispinta cambio 90x50x22 mm</p>	<p><b>Art. 15280</b></p> 	<p>OEM 5119290 - 5119875 - 5122028 - 87345759 Cuscinetto reggispinta cambio 90x50x22 mm</p>
	<p><b>Art. 16167</b></p> 	<p>OEM 4993817 Collare</p>	<p><b>Art. 15800</b></p> 	<p>Nuova Versione OEM 5197980</p>
	<p><b>Art. 15862</b></p> 	<p>OEM 5103178 Cuscinetto reggispinta</p>	<p><b>Art. 15863</b></p> 	<p>OEM 599930 Cuscinetto reggispinta</p>
<p><b>Art. 15862</b></p> 	<p>OEM 5103178 Cuscinetto reggispinta</p>	<p><b>Art. 15751</b></p> 	<p>OEM 26794570 Cuscinetto PTO 65x100x11 mm <b>Per mod: 480S-500S-540S-550-600-640</b></p>	



















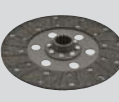











(segue AGRIFULL RUOTE)



# Frizioni e loro componenti

CLUTCHES - CLUTCH DISK - BEARING - COUPLING - LEVER - SET-REVISION

## segue AGRIFULL RUOTE











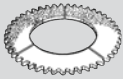

<p>8065 - 8066</p>	<p><b>Art. Kit 15975</b></p>      			<p>OEM 87689655</p> <p>Kit composto da:                  - Meccanismo 15529                  - Disco PTO 15943                  - Cuscinetti 15990 - 63896 - 63867</p>
<p><b>Art. 15529</b></p> 	<p>OEM 5154835                  Meccanismo a 6 leve completo di disco centrale rigido in ferodo. Fornito senza il disco PTO.                  Piatto Ø 280 mm (11")                  Intercambiabile con meccanismo VALEO</p>	<p><b>Art. 15943</b></p>  <p>OEM 5145715 - 5154703                  Disco PTO rigido in ferodo 280x165x3 mm 25x22EV - Z.10</p>	<p><b>Art. 15520</b></p>  <p>OEM 5145715 - 5154703                  Disco PTO rigido in ferodo 280x165x3 mm 25x22EV - Z.10</p>	
<p><b>Art. 15631</b></p> 	<p>OEM 5145714 - 5155300                  Disco centrale rigido in ferodo 280x165x4,4 mm 40x35EV - Z.14</p>	<p><b>Art. 15990</b></p>  <p>OEM 5119290 5119875 - 5122028 - 87345759                  Cuscinetto reggispinta cambio 90x50x22 mm</p>	<p><b>Art. 15280</b></p>  <p>OEM 5119290 - 5119875 - 5122028 - 87345759                  Cuscinetto reggispinta cambio 90x50x22 mm</p> <p><b>Art. 15800</b></p> <p>Nuova Versione OEM 5197980</p>	
		<p><b>Art. 62951</b></p>  <p>OEM 24905360 - 84455696                  Cuscinetto reggispinta PTO 70x110x20 mm</p> <p><b>Art. FAG 63896</b></p>	<p><b>Art. 62581</b></p>  <p>OEM 28043280                  Cuscinetto volano 17x47x14 mm</p> <p><b>Art. FAG 63867</b></p>	
<p>8085 - 8095 80105</p> <p><b>MECCANISMO RINFORZATO</b></p> <p>N.B.: Quando si sostituisce un meccanismo non rinforzato con un meccanismo rinforzato, bisogna sostituire anche il disco PTO.</p>	<p><b>Art. Kit 15932</b></p>   			<p>Kit composto da:                  - Meccanismo 15530                  - Disco PTO 15966</p>
	<p><b>Art. Kit 15978</b></p>      			<p>OEM                  Kit composto da:                  - Meccanismo 15530                  - Disco PTO 15966                  - Cuscinetti 15990 - 63897 - 63869</p>
<p><b>Art. 15530</b></p> 	<p>OEM 5163936                  Meccanismo a 6 leve completo di disco centrale metalceramico a 7 pale.                  Fornito senza il disco PTO.                  Piatto Ø 310 mm (12")                  Intercambiabile con meccanismo VALEO</p>	<p><b>Art. 15966</b></p>  <p>OEM 5144741 - 5154514                  Disco PTO rigido in ferodo, per meccanismo 15530 310x190x3 mm 28x24EV - Z.10</p>	<p><b>Art. 15532</b></p>  <p>OEM 5144741 - 5154514                  Disco PTO rigido in ferodo, per meccanismo 15530 310x190x3 mm 28x24EV - Z.10</p>	
<p><b>Art. 15531</b></p> 	<p>OEM 5163937                  Disco centrale metalceramico rigido a 7 pale per meccanismo 15530                  Ø 310 sinterizzato (12")                  45x40EV - Z.16</p>	<p><b>Art. 15990</b></p>  <p>OEM 5119290 5119875 - 5122028                  Cuscinetto reggispinta cambio 90x50x22 mm</p>	<p><b>Art. 15280</b></p>  <p>OEM 5119290 - 5119875 - 5122028 - 87345759                  Cuscinetto reggispinta cambio 90x50x22 mm</p> <p><b>Art. 15800</b></p> <p>Nuova Versione OEM 5197980</p>	
		<p><b>Art. 62952</b></p>  <p>OEM 5112084 - 47127081                  Cuscinetto reggispinta PTO 75x115x20 mm</p> <p><b>Art. FAG 63897</b></p>	<p><b>Art. 62583</b></p>  <p>OEM 28042740                  Cuscinetto volano 20x47x14 mm</p> <p><b>Art. FAG 63869</b></p>	

# Frizioni e loro componenti







CLUTCHES - CLUTCH DISK - BEARING - COUPLING - LEVER - SET-REVISION

11







## AGRIFULL CINGOLI

C80.50	<b>Art. 15173</b>  OEM 588433 - 5160719 Anello frizione centrale con dentatura esterna 277x156x10 mm (1/3T) - 45 denti	<b>Art. 15176</b>  OEM 5109937 - 5109934 - 5161615 Anello frizione di sterzo in tessuto con dentatura esterna 239x180x4,8 - 28 denti	<b>Art. 15389</b>  OEM 566519 Anello frizione di sterzo con dentatura interna 229x171x2 mm 21 denti
	<b>Art. 15388</b>  OEM 571707 - 5160601 Anello frizione cambio a 8 fori 88x48x4,5 mm	<b>Art. 15174</b>  OEM 5109937 - 5109934 - 5161615 Anello frizione di sterzo in conglomerato con dentatura esterna 239x180x4,8 - 28 denti	
C80-70 SPECIAL	<b>Art. 15177</b>  OEM 596511 - 5160602 Anello frizione centrale con dentatura esterna 277x166x7 mm 45 denti	<b>Art. 15176</b>  OEM 5109937 - 5109934 - 5161615 Anello frizione di sterzo in tessuto con dentatura esterna 239x180x4,8 - 28 denti	<b>Art. 15389</b>  OEM 566519 Anello frizione di sterzo con dentatura interna 229x171x2 mm 21 denti
	<b>Art. 15388</b>  OEM 571707 - 5160601 Anello frizione cambio a 8 fori 88x48x4,5 mm	<b>Art. 15174</b>  OEM 5109937 - 5109934 - 5161615 Anello frizione di sterzo in conglomerato con dentatura esterna 239x180x4,8 - 28 denti	
55 CV - CF - 60 C - CL - 70 C - CL - 80 C - C 80.46 - C 80.56 - C 80.66 - C 80.76	<b>Art. 15176</b>  OEM 5109937 - 5109934 - 5161615 Anello frizione di sterzo in tessuto con dentatura esterna 239x180x4,8 - 28 denti	<b>Art. 15174</b>  OEM 5109937 - 5109934 - 5161615 Anello frizione di sterzo in conglomerato con dentatura esterna 239x180x4,8 - 28 denti	<b>Art. 15389</b>  OEM 566519 Anello frizione di sterzo con dentatura interna 229x171x2 mm 21 denti

## ARBOS MIETITREBBIE

1000 MAYOR	<b>Art. 15234</b>  OEM 16295 Disco frizione rigido in ferodo 250x155x4,3 mm 35x29x5,5 mm - Z.10	<b>Art. 15365</b>  OEM Cuscinetto reggispinta	<b>Art. 15364</b>  OEM 4561428 Manicotto
REKORD SUPEREKORD 1220 - 120 - 125 PANTERA - LINCE GIAGUAR - 165 TIGRE	<b>Art. 15169</b>  OEM R3731 - B46575 Disco frizione rigido in ferodo 279x171x4,3 mm 35x29x5,5 mm - Z.10	<b>Art. 15365</b>  OEM Cuscinetto reggispinta	<b>Art. 15364</b>  OEM 4561428 Manicotto





















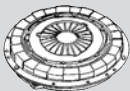



## BARBIERI

MOTOCOLTIVATORI: GAZZELLA - PUMA 2ª SERIE	<b>Art. 15588</b>  OEM Frizione monodisco con molle a diaframma Piatto Ø 90 mm	<b>Art. 15525</b>  OEM Disco frizione rigido in ferodo 86x50x3,5 mm 15x12EV Z.8	<b>Art. 15763</b>  OEM Disco frizione rigido in ferodo 89x55x11 mm 15x12EV - Z.8 Ricambio per frizione 15588
			<b>Art. 15042</b>  OEM Manicotto con cuscinetto reggispinta
MOTOCOLTIVATORI: GAZZELLA - PUMA CON MOTORE JLO (segue BARBIERI)	<b>Art. 15590</b>  OEM Frizione monodisco con molle a diaframma Piatto Ø 90 mm	<b>Art. 15525</b>  OEM Disco frizione rigido in ferodo 86x50x3,5 mm 15x12EV - Z.8	<b>Art. 15042</b>  OEM Manicotto con cuscinetto reggispinta

# Frizioni e loro componenti

CLUTCHES - CLUTCH DISK - BEARING - COUPLING - LEVER - SET-REVISION

## segue BARBIERI















MOTOCOLTIVATORI: GAZZELLA - PUMA FB serie 310 - 900	<b>Art. 15321</b>  OEM Frizione monodisco con molle a diaframma Piatto Ø 95 mm	<b>Art. 15189</b>  OEM Disco frizione rigido in ferodo 94x61x1,5 mm 15x12EV Z.8	<b>Art. 15042</b>  OEM Manicotto con cuscinetto reggispinta
		<b>Art. 15050</b>  OEM Cuscinetto reggispinta	<b>Art. 15056</b>  OEM Leva a forcella
MOTOCAPPE: ZEBRA - FB serie 210	<b>Art. 15002</b>  OEM Frizione monodisco con molle a diaframma Piatto Ø 110 mm	<b>Art. 15019</b>  OEM Disco frizione rigido in ferodo 110x58x1,5 mm 15x12EV Z.8	<b>Art. 15042</b>  OEM Manicotto con cuscinetto reggispinta
		<b>Art. 15050</b>  OEM Cuscinetto reggispinta	<b>Art. 15057</b>  OEM Leva a forcella
MOTOCOLTIVATORI: GIAGUARO - Serie 1600	<b>Art. 15339</b>  OEM Frizione bidisco completa di disco centrale Piatto Ø 110 mm	<b>Art. 15022</b>  OEM Disco frizione rigido in sinterizzato Ø 110 mm sinterizzato 15x12EV Z.8	<b>Art. 15042</b>  OEM Manicotto con cuscinetto reggispinta
		<b>Art. 15050</b>  OEM Cuscinetto reggispinta	<b>Art. 15058</b>  OEM Leva a forcella
MOTOCOLTIVATORI: PIONEER - LEOPARD - FB serie 1400	<b>Art. 15004</b>  OEM Frizione monodisco a molle elicoidali Piatto Ø 160 mm	<b>Art. 15025</b>  OEM Disco frizione rigido in ferodo 160x110x3,8 mm 19x15,5x3 mm Z.10	<b>Art. 15059</b>  OEM Leva a forcella
	<b>Art. 15051</b>  OEM Cuscinetto reggispinta	<b>Art. 15048</b>  OEM Manicotto	
MOTOCOLTIVATORI: MOTOFALCIATRICI	<b>Art. 15610</b>  OEM Frizione Ø 103x70,5 mm a dischi multipli con 4 dischi 15x12EV Z.8 Albero Ø23 mm		<b>Art. 15629</b>  OEM Manicotto con cuscinetto reggispinta
MOTOCOLTIVATORI: REKORD (fino al 2004)	<b>Art. 15608</b>  OEM Disco frizione rigido in ferodo 122x80x11,5 mm 28x25EV Z.15		
MOTOCOLTIVATORI: REKORD (dal 2005)	<b>Art. 15823</b>  OEM Frizione monodisco Ø 142x92 mm 15x12 mm Z.8 Albero Ø 23 mm	<b>Art. 15824</b>  OEM Disco frizione rigido in ferodo 116x80x11,5 mm 28x25 mm DIN 5482 Z.15	

# Frizioni e loro componenti









CLUTCHES - CLUTCH DISK - BEARING - COUPLING - LEVER - SET-REVISION

11

## segue BARBIERI

TRATTORINI: PANTHER DELFINO FB serie 1800	<b>Art. 15005</b> 	OEM Frizione monodisco a molle elicoidali Piatto Ø 187 mm	<b>Art. 15026</b> 	OEM Disco frizione rigido in ferodo 184x127x3,8 mm 19x15,5x3 mm - Z.10	<b>Art. 15060</b> 	OEM Leva a forcella
	<b>Art. 15051</b> 	OEM Cuscinetto reggispinta	<b>Art. 15047</b> 	OEM Manicotto		
TRATTORINI: FURIA FB serie 3500 (2-4 RM)	<b>Art. 15006</b> 	OEM Frizione monodisco a molle elicoidali Piatto Ø 187 mm	<b>Art. 15035</b> 	OEM Disco frizione rigido in ferodo 181x127x3,3 mm 22x19EV - Z.13	<b>Art. 15060</b> 	OEM Leva a forcella
	<b>Art. 15052</b> 	OEM Cuscinetto reggispinta 68x36x19 mm	<b>Art. 15047</b> 	OEM Manicotto		
TRATTORINI: FURIA FB serie 3500 (4 RM)	<b>Art. 15297</b> 	OEM Frizione monodisco a molle elicoidali Piatto Ø 216 mm	<b>Art. 15191</b> 	OEM Disco frizione rigido in ferodo 216x152x4 mm 22x19EV - Z.13	<b>Art. 15061</b> 	OEM Leva a forcella
	<b>Art. 15052</b> 	OEM Cuscinetto reggispinta 68x36x19 mm	<b>Art. 15047</b> 	OEM Manicotto		









## BCS

MOTOCOLTIVATORI E MOTOFALCIATRICI SERIE 600/700	<b>Art. 15001</b> 	OEM 592.48106 Frizione conica Ø 103x100 mm Albero 22,5 mm Conicità 1:5 12x15EV - Z.8			
	<b>Art. 15527</b> 	Frizione Ø 103x99 mm a dischi multipli con 5 dischi 12x15EV - Z.8 Albero Ø23	<b>Art. 15584</b> 	OEM Serie dischi completa - composta da 5 dischi di Ø 93 mm	
MOTOCOLTIVATORI 705	<b>Art. 15016</b> 	OEM 581010076 Frizione monodisco a molle elicoidali Piatto Ø 155 mm	<b>Art. 15032</b> 	OEM 581010091 Disco frizione rigido 155x114x4,5 mm 16x13x3,5 mm - Z.6	
	<b>Art. 15051</b> 	OEM 581010102 Cuscinetto reggispinta			
MOTOCOLTIVATORE MOTOFALCIAT. 720 (per sostituzione autoventilante)	<b>Art. 15825</b> 	OEM Frizione Ø 103x113,5 mm a dischi multipli con 4 dischi 12x15EV - Z.8 Albero Ø23	<b>Art. 15630</b> 	OEM Disco frizione sinterizzato Ø 93 mm	
MOTOFALCIATRICI E MOTOCOLTIVATORI 715 - 735 (segue BCS)	<b>Art. 15001</b> 	OEM 592.48106 Frizione conica Ø 103x100 mm Albero Ø 22,5 mm Conicità 1:5 15x12EV - Z.8			



# Frizioni e loro componenti

CLUTCHES - CLUTCH DISK - BEARING - COUPLING - LEVER - SET-REVISION





## segue BCS

MOTOFALCIATRICE 622	<b>Art. 15328</b> 	OEM 590024260 Disco frizione rigido 178x133x5 mm 25x20EV - Z.15		
MOTOCOLTIVATORE 745 (motore Lombardini 3LD510)	<b>Art. 15747</b> 	OEM Frizione Ø 103x104 a dischi multipli con 5 dischi 12x15 mm - Z.8 albero Ø 24 mm filetto M16x1,5	<b>Art. 15584</b> 	OEM Serie dischi completa - composta da 5 dischi di Ø 93 mm
VICTOR 300 AR	<b>Art. Kit 16082</b>  	OEM 58172957 Kit meccanismo più disco frizione. Piatto Ø 180 mm 17x15 - Z.20		
INVICTUS K400	<b>Art. 15720</b> 	OEM Meccanismo a 3 leve completo di disco centrale in ferodo. Piatto Ø 180 mm	<b>Art. 15707</b> 	OEM Disco PTO in ferodo 180x127x3,8 mm 20x17 mm - Z.12
			<b>Art. 15272</b> 	OEM Cuscinetto reggispira piccolo 82x50x28
			<b>Art. 15807</b> 	OEM Cuscinetto reggispira cambio 82x50x26

## BEDOGNI

MOTOFALCIATRICE E MOTOCOLTIVATORE COLIBRÌ	<b>Art. 15019</b> 	OEM 60053 Disco frizione rigido 110x58x1,5 mm 15x12EV - Z.8		
MOTOCOLTIVATORI COLIBRÌ	<b>Art. 15022</b> 	OEM Disco rigido sinterizzato 110x75x3 mm 15x12EV - Z.8		
MOTOFALCIATRICE OLIMPIA	<b>Art. 15153</b> 	OEM 12231 Disco frizione rigido 178x133x2,8 mm 23x18x3 mm - Z.10		

## BENASSI MECCANICA

MOTAZAPPA RL 300 - SM (FRIZIONE CORTA)	<b>Art. 15318</b> 	OEM Frizione conica Ø 103x69 mm Albero Ø 22,5 Larghezza 66,5 mm Conicità 1:5 15x12EV - Z.8		
MOTAZAPPA RL 300 (FRIZIONE LUNGA)	<b>Art. 15001</b> 	OEM Frizione conica Ø 103x100 mm Albero Ø 22,5 Conicità 1:5 Larghezza 97,5 mm 15x12EV - Z.8		
MOTAZAPPA RL 95 - 100 - 634L MOTOCOLTIVATORI 421	<b>Art. 15002</b> 	OEM Frizione monodisco con molle a diaframma Piatto Ø 110 mm	<b>Art. 15019</b> 	OEM Disco frizione rigido 110x58x1,5 mm 15x12EV - Z.8
MOTAZAPPA RL309 MOTOCOLTIVATORI 419	<b>Art. 15611</b> 	OEM Disco frizione rigido sinterizzato 82x60x2 mm 50x45EV - Z.24		





# Frizioni e loro componenti









CLUTCHES - CLUTCH DISK - BEARING - COUPLING - LEVER - SET-REVISION

11

## BENASSI SPA

MOTAZAPPA BL 105	<b>Art. 15519</b> 	OEM Frizione conica Ø 103x90 mm Albero 22,5 mm Conicità 1:5 14x11x3 - Z.6		
MOTAZAPPA 10 HP - BL105  MOTOFALCIATRICE	<b>Art. 15521</b> 	OEM Frizione Ø 103x90 mm a dischi multipli con 4 dischi 14x11x3 mm Z.6 Albero Ø23		













## BERTOLINI

MOTOCOLTIVATORI SERIE 300	<b>Art. 15160</b> 	OEM 81.9024.00 Disco frizione rigido 80x60x2,3 mm 20x17EV Z.12		
MOTOFALCIATRICI BRF 58	<b>Art. 15193</b> 	OEM 81.9030.00 Disco frizione rigido 145x102x4 mm 26x21x3 mm Z.10		
MOTOFALCIATRICI 124 - 125 - 126	<b>Art. 15194</b> 	OEM 81.9036.00 Disco frizione rigido 178x134x2,5 mm 26x21x3 mm Z.10		
MOTOCOLTIVATORI 305	<b>Art. 15002</b> 	OEM 81.9220.00 Frizione monodisco con molle a diaframma Piatto Ø 110 mm	<b>Art. 15019</b> 	OEM 81.9221.00 Disco frizione rigido 110x58x1,5 mm 15x12EV Z.8
	<b>Art. 15042</b> 	OEM 81.9222.00 Manicotto con cuscinetto reggispinta	<b>Art. 15057</b> 	OEM 81.9218.00 Leva a forcella
MOTOCOLTIVATORI SERIE 307 (FRIZIONE LUNGA)	<b>Art. 15001</b> 	OEM Frizione conica Ø 103x100 mm Albero Ø 23 mm Conicità 1:5 Larghezza 97,5 mm 12x15EV - Z.8		
MOTOCOLTIVATORI SERIE 307 - 406 (FRIZIONE CORTA) MOTOFALCIATRICE 134-140  (segue BERTOLINI)	<b>Art. 15533</b> 	OEM120003 Frizione conica Ø 103x87 mm Albero Ø 22,5 mm Conicità 1:5 15x12EV - Z.8		

# Frizioni e loro componenti

CLUTCHES - CLUTCH DISK - BEARING - COUPLING - LEVER - SET-REVISION

## segue BERTOLINI











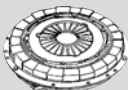







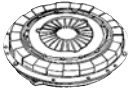

MOTOFALCIATRICE SERIE 136 - 312	<b>Art. 15633</b> 	OEM Frizione Ø 103x87 mm a dischi multipli con 4 dischi 12x15EV - Z.8 Albero Ø23 mm Conicità 1:5		
MOTOFALCIATRICE CON MOTORE ACME AT 330 - ALN 330	<b>Art. 15585</b> 	OEM Frizione Ø 103x87 mm a dischi multipli con 4 dischi 12x15EV - Z.8 Albero Ø 23 mm Conicità 1:5 Vite lunga		
MOTOCOLTIVATORI: BM 10 310 (1ª serie) 324 (1ª serie)	<b>Art. 15195</b> 	OEM 81.9056.00 Disco frizione rigido 155x114x1,5 mm 22x18x3,5 mm Z.10	<b>Art. 15044</b> 	OEM Manicotto con anello in grafite
MOTOCOLTIVATORI: BM 310 310 (2ª serie) 324 (2ª serie)	<b>Art. 15196</b> 	OEM 81.9085.00 Disco frizione rigido 160x110x3,8 mm 22x19EV Z.13		
MOTOCOLTIVATORI: 310 S TRATTORINI 310T - 510	<b>Art. 15013</b> 	OEM 81.9109.20 Frizione monodisco con molle a diaframma Piatto Ø 160 mm	<b>Art. 15029</b> 	OEM 81.9112.00 Disco frizione rigido 160x110x3,8 mm 23x20EV Z.20
	<b>Art. 15043</b> 	OEM 81.9134.30 Manicotto con cuscinetto reggispinta		
MOTOCOLTIVATORI 315	<b>Art. 15003</b> 	OEM 81.9032.00 Frizione monodisco con molle elicoidali Piatto Ø 140 mm	<b>Art. 15020</b> 	OEM 81.9033.00 Disco frizione rigido 140x96x3,2 mm 17x15EV Z.20
	<b>Art. 15044</b> 	OEM Manicotto con anello in grafite		
MOTOCOLTIVATORI: 318  (segue BERTOLINI)	<b>Art. 15013</b> 	OEM 81.9109.20 Frizione monodisco con molle a diaframma Piatto Ø 160 mm	<b>Art. 15198</b> 	OEM 81.9134.30 Manicotto con cuscinetto reggispinta

# Frizioni e loro componenti

CLUTCHES - CLUTCH DISK - BEARING - COUPLING - LEVER - SET-REVISION

11

## segue BERTOLINI











MOTOCOLTIVATORI 320	<b>Art. 15330</b> OEM 81.9117.00 Frizione monodisco con molle a diaframma Piatto Ø 180 mm 	<b>Art. 15035</b> OEM 81.9119.00 Disco frizione rigido 181x127x4 mm 23x19EV Z.13 	<b>Art. 15061</b> OEM 81.9127.00 Leva a forcella 
	<b>Art. 15054</b> OEM Cuscinetto reggispinta 	<b>Art. 15046</b> OEM Manicotto 	
TRATTORINI 330	<b>Art. 15331</b> OEM 81.9301.00 Frizione monodisco con molle a diaframma Piatto Ø 180 mm 	<b>Art. 15035</b> OEM 81.9119.00 Disco frizione rigido 181x127x4 mm 23x19EV Z.13 	
	<b>Art. 15332</b> OEM 81.9302.00 Manicotto con cuscinetto reggispinta 	<b>Art. 15333</b> OEM 81.9303.00 Leva a forcella 	
MOTOCOLTIVATORI BM 12 - TRATTORINI 412T	<b>Art. 15296</b> OEM 81.9003.00 Monodisco con molle elicoidali Piatto Ø 187 mm 	<b>Art. 15141</b> OEM 81.9006.00 Disco frizione rigido 184x127x3,8 mm 22x18x3,5 Z.10 	
	<b>Art. 15052</b> OEM Cuscinetto reggispinta 68x36x19 mm 	<b>Art. 15047</b> OEM 81.9009.00 Manicotto 	
421 DIESEL 1C 424 - 431 - 432 - DIESEL 2C - 428 - 450	<b>Art. 15012</b> OEM 81.9134.00 Frizione monodisco con molle a diaframma Piatto Ø 180 mm 	<b>Art. 15031</b> OEM 81.9134.20 Disco frizione rigido 181x127x3,8 mm 23x20EV Z.20 	
	<b>Art. 15043</b> OEM 81.9134.30 Manicotto con cuscinetto reggispinta 	<b>Art. 15065</b> OEM 81.9134.10 Leva a forcella 	
450 DIESEL 3 CILINDRI	<b>Art. 15014</b> OEM 81.9134.60 Frizione monodisco con molle a diaframma Piatto Ø 180 mm 	<b>Art. 15031</b> OEM 81.9134.20 Disco frizione rigido 181x127x3,8 mm 23x20EV Z.20 	
	<b>Art. 15043</b> OEM 81.9134.30 Manicotto con cuscinetto reggispinta 	<b>Art. 15065</b> OEM 81.9134.10 Leva a forcella 	

(segue BERTOLINI)

# Frizioni e loro componenti

CLUTCHES - CLUTCH DISK - BEARING - COUPLING - LEVER - SET-REVISION

## segue BERTOLINI

TRATTORINI 530	 <b>Art. 15338</b> OEM 81.9143.00 Frizione monodisco con molle a diaframma Piatto Ø 215 mm	 <b>Art. 15191</b> OEM 81.9144.20 Disco frizione rigido 216x152x4 mm 23x19EV - Z.13	
	 <b>Art. 15332</b> OEM 81.9302.00 Manicotto con cuscinetto reggispinta	 <b>Art. 15333</b> OEM 81.9303.00 Leva a forcella	
MOTOCOLTIVATORI SERIE 406 (MOTORE ACME ALN 330)	 <b>Art. 15632</b> OEM Frizione conica Ø 103x87 mm Perno lungo Albero Ø 22,5 mm Conicità 1:5 - Vite lunga 15x12EV - Z.8		
MOTOCOLTIVATORI SERIE 406 (MOTORE HONDA/ B&S)	 <b>Art. 15713</b> OEM Frizione conica Ø 103x84,5 mm Albero 19,5 mm 15x12 Z.8		
MOTOFALCIATRICE SERIE 408 (MOTORE B&S)	 <b>Art. 15714</b> OEM Frizione Ø 103x130,5 mm albero 25,4 mm a dischi multipli con 4 dischi 15x12 - Z.8	 <b>Art. 15630</b> OEM Disco frizione sinterizzato Ø 93 mm	
MOTOFALCIATRICE SERIE 408 (MOTORE HONDA)	 <b>Art. 15826</b> OEM Frizione Ø 103x131 mm a dischi multipli con 4 dischi 12x15EV - Z.8 Albero Ø 25,4 mm	 <b>Art. 15630</b> OEM Disco frizione sinterizzato Ø 93 mm	
MOTOFALCIATRICE M 141 (Frizione di sterzo)	 <b>Art. 15827</b> OEM Frizione Ø 103x96 mm a dischi multipli con 8 dischi 25x22 - Z.14		

# Frizioni e loro componenti





CLUTCHES - CLUTCH DISK - BEARING - COUPLING - LEVER - SET-REVISION

11



## BERTOLINI - YABE - EMAX - CAMBIO NIBBI D.

MOTOCOLTIVATORE 401/402/403  <b>ATTENZIONE:</b> <b>Vite fissaggio corta</b>	<b>Art. 15828</b> 	OEM Frizione Ø 100x75 mm a 3 dischi 12x15EV - Z.8 Albero Ø 23 mm		
MOTOCOLTIVATORE 401/402/403 (motore HONDA G x160)	<b>Art. 15829</b> 	OEM Frizione Ø 100x104 mm a 3 dischi 12x15EV - Z.8 Albero Ø 19,05 mm		
MOTOCOLTIVATORE 401/402/403 (motore HONDA G c160)	<b>Art. 15830</b> 	OEM Frizione Ø 100x90 mm a 3 dischi 12x15EV - Z.8 Albero Ø 19,05 mm		
MOTOCOLTIVATORE 401/402/403 (motore ALN 330)  <b>ATTENZIONE:</b> <b>Vite fissaggio lunga</b>	<b>Art. 15831</b> 	OEM Frizione Ø 100x75 mm a 3 dischi 12x15EV - Z.8 Albero Ø 23 mm		
MOTOCOLTIVATORE 401/402/403 (motore ROBYN EY20)	<b>Art. 15832</b> 	OEM Frizione Ø 100x104 mm a 3 dischi 12x15EV - Z.8 Albero Ø 19,05 mm		
MOTOCOLTIVATORE 401/402/403 (motore HONDA)	<b>Art. 15833</b> 	OEM Frizione Ø 100x105 mm a 3 dischi 12x15EV - Z.8 Albero Ø 20 mm		

## BMW

MOTOZAPPA	<b>Art. 15318</b> 	OEM Frizione conica Ø 103x69 mm Albero Ø 22,5 mm Conicità 1:5 15x12EV - Z.8		
MOTOZAPPA	<b>Art. 15587</b> 	OEM Frizione conica Ø 103x91 mm Albero Ø 22,5 mm Conicità 1:5 15x12EV - Z.8		
MOTOZAPPA	<b>Art. 15339</b> 	OEM Frizione bidisco con molle a diaframma - completa di disco centrale Piatto Ø 110 mm	<b>Art. 15019</b> 	OEM Disco frizione rigido in ferodo 110x58x3 mm 15x12EV Z.8
			<b>Art. 15042</b> 	OEM Manicotto con cuscinetto reggispinta

## BRUMITAL











MOTOZAPPE SIMPLEX  (segue BRUMITAL)	<b>Art. 15588</b> 	OEM Frizione monodisco con molle a diaframma Piatto Ø 90 mm	<b>Art. 15525</b> 	OEM Disco frizione rigido in ferodo 86x50x3,5 mm 15x12EV Z.8 Ricambio per frizione PI-VI
			<b>Art. 15763</b> 	OEM Disco frizione rigido in ferodo 89x55x11 mm 15x12EV Z.8 Ricambio per frizione 15588



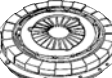

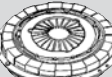
# Frizioni e loro componenti

CLUTCHES - CLUTCH DISK - BEARING - COUPLING - LEVER - SET-REVISION











## segue BRUMITAL

MOTOZAPPE SIMPLEX	 <b>Art. 15321</b> OEM Frizione monodisco con molle a diaframma Piatto Ø 95 mm 15x12 Z.8	 <b>Art. 15189</b> OEM Disco frizione rigido 94x61x1,5 mm 15x12EV Z.8	
	 <b>Art. 15050</b> OEM Cuscinetto reggispinta	 <b>Art. 15042</b> OEM Manicotto con cuscinetto reggispinta	
MOTOZAPPE	 <b>Art. 15002</b> OEM Frizione monodisco con molle a diaframma Piatto Ø 110 mm	 <b>Art. 15022</b> OEM Disco rigido sinterizzato 110x75x3 mm 15x12EV - Z.8	 <b>Art. 15042</b> OEM Manicotto con cuscinetto reggispinta
MOTOZAPPE CON FRIZIONE DI Ø 110 MM SOTTOCHIOMA MULETTO	 <b>Art. 15339</b> OEM Frizione bidisco Piatto Ø 110 mm	 <b>Art. 15022</b> OEM Disco frizione sinterizzato Ø 110 mm 15x12EV - Z.8	
	 <b>Art. 15050</b> OEM Cuscinetto reggispinta	 <b>Art. 15042</b> OEM Manicotto con cuscinetto reggispinta	

## CAMISA

MOTOCOLTIVATORE	 <b>Art. 15594</b> OEM Frizione conica Ø 103x99 mm Albero Ø 22,5 mm Conicità 1:5 15x12EV - Z.8		
MOTOCOLTIVATORE 10 HP	 <b>Art. 15589</b> OEM Frizione Ø 103x99 mm a dischi multipli con 4 dischi 15x12EV - Z.8 Albero Ø23	 <b>Art. 15630</b> OEM Disco frizione sinterizzato Ø 93 mm	

## CARON















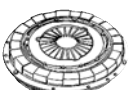

















TRANSPORTER C 12	 <b>Art. 15016</b> OEM Frizione monodisco con molle elicoidali Piatto Ø 155 mm	 <b>Art. 15028</b> OEM Disco frizione rigido 160x112x3 mm 17x15EV Z.20	
	 <b>Art. 15051</b> OEM Cuscinetto reggispinta	 <b>Art. 15048</b> OEM Manicotto	
TRANSPORTER MC 20	 <b>Art. 15014</b> OEM Frizione monodisco con molle a diaframma Piatto Ø 180 mm	 <b>Art. 15031</b> OEM Disco frizione rigido 181x127x3,8 mm 23x20EV - Z.20	 <b>Art. 15043</b> OEM Manicotto con cuscinetto reggispinta
TRANSPORTER MC 40	 <b>Art. 15942</b> OEM Frizione monodisco con molle a diaframma rinforzate Piatto Ø 180 mm	 <b>Art. 15031</b> OEM Disco frizione rigido 181x127x3,8 mm 23x20EV Z.20	 <b>Art. 15043</b> OEM Manicotto con cuscinetto reggispinta

# Frizioni e loro componenti

CLUTCHES - CLUTCH DISK - BEARING - COUPLING - LEVER - SET-REVISION

11













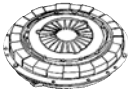

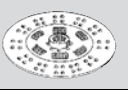

## CARRARO ANTONIO

MOTOCOLTIVATORI SERIE 47 - 240 - 295 (2ª SERIE) 524 - 530	<b>Art. 15588</b>  OEM Frizione monodisco con molle a diaframma Piatto Ø 90 mm	<b>Art. 15525</b>  OEM Disco frizione rigido in ferodo 86x50x3,5 15x12EV Z.8	<b>Art. 15189</b>  OEM Disco frizione rigido in ferodo 94x60x3,5 15x12EV Z.8	<b>Art. 15763</b>  OEM Disco frizione rigido in ferodo 89x55x11 15x12EV Z.8 per art. 15588
CARRARINO SERIE: MINI E SPECIAL	<b>Art. 15002</b>  OEM 5.107.502 Frizione monodisco con molle a diaframma Piatto Ø 110 mm	<b>Art. 15019</b>  OEM 5.108.501 Disco frizione rigido 110x58x1,5 mm 15x12EV Z.8	<b>Art. 15066</b>  OEM Leva a forcella	
	<b>Art. 15050</b>  OEM Cuscinetto reggispinta	<b>Art. 15042</b>  OEM Manicotto con cuscinetto reggispinta		
CARRARINO SERIE SUPER	<b>Art. 15334</b>  OEM 5.107.503 Frizione bidisco con disco frizione lato cambio inserito Piatto Ø 110 mm	<b>Art. 15019</b>  OEM 5.108.501 Disco frizione rigido 110x58x1,5 mm 15x12EV Z.8	<b>Art. 15066</b>  OEM Leva a forcella	
	<b>Art. 15050</b>  OEM Cuscinetto reggispinta	<b>Art. 15042</b>  OEM Manicotto con cuscinetto reggispinta		
TIGRE 2800	<b>Art. 15298</b>  OEM 5.107.511 Frizione monodisco con molle a diaframma Piatto Ø 160 mm	<b>Art. 15028</b>  OEM 5.108.514 Disco frizione rigido in ferodo 160x112x3 mm 17x15EV Z.20	<b>Art. 15741</b>  OEM 5073504 Manicotto con cuscinetto reggispinta	
TIGRE RS - TIGROTTO RS - TIGRE TRANSPORTER - TIGROTTO TRANSPORTER	<b>Art. 15298</b>  OEM 5.107.511 Frizione monodisco con molle elicoidali Piatto Ø 160 mm	<b>Art. 15312</b>  OEM 5.108.516 Disco frizione con molle parastrappi 155x114x3 mm 17x15EV - Z.20	<b>Art. 15741</b>  OEM 5073504 Manicotto con cuscinetto reggispinta	
MOTOCOLTIVATORE TIGRE SCARABEO	<b>Art. 15715</b>  OEM Frizione monodisco con molle elicoidali Piatto Ø 160 mm	<b>Art. 15040</b>  OEM Disco frizione rigido in ferodo 160x110x3,2 mm 22x19x3,5 - Z.10		
3400 SUPER TIGRE E TIGRONE - 3600 SUPER TIGRE E TIGRONE - 620 - 625 - 635 - SUPER TIGRE	<b>Art. 15336</b>  OEM 5.107.506 Frizione monodisco con molle a diaframma Piatto Ø 180 mm	<b>Art. 15199</b>  OEM 5.108.504 Disco frizione rigido 181x124x3,8 mm 22x18x3,5 mm Z.10	<b>Art. 15302</b>  OEM 5.073.502 Manicotto con cuscinetto reggispinta Ø foro 33 mm	
4000 SUPER TIGRE - TIGRONE 620 - 625 - 635 - SUPER TIGRE (2ª SERIE)	<b>Art. 15337</b>  OEM 5.107.505 Frizione monodisco con molle a diaframma Piatto Ø 200 mm	<b>Art. 15200</b>  OEM 5.108.503 Disco frizione rigido 200x130x3,8 mm 22x18x3,5 mm - Z.10	<b>Art. 15302</b>  OEM 5.073.502 Manicotto con cuscinetto reggispinta Ø foro 33 mm	
SUPER TIGRE - TIGRONE 4800 - TIGRONE 4800 KING - TIGRONE 6000 KING - SERIE 700 MODELLI VARI (segue CARRARO A.)	<b>Art. 15338</b>  OEM 5.107.504 Frizione monodisco con molle a diaframma Piatto Ø 215 mm	<b>Art. 15201</b>  OEM 5.108.502 Disco frizione rigido 215x145x3,8 mm 22x18x3,5 mm Z.10	<b>Art. 15302</b>  OEM 5.073.502 Manicotto con cuscinetto reggispinta Ø foro 33 mm	<b>Art. 15740</b>  OEM Manicotto con cuscinetto reggispinta Ø foro 36 mm

# Frizioni e loro componenti

CLUTCHES - CLUTCH DISK - BEARING - COUPLING - LEVER - SET-REVISION

## segue CARRARO ANTONIO

TIGRONE 5500 - 7000 - 7700	<b>Art. 15656</b> 	OEM 40.21.0001 Frizione monodisco con molle a diaframma Piatto Ø 250 mm	<b>Art. 15156</b> OEM 40.21.1001 Disco frizione 250x145x3,8 mm 35x31 mm - Z.18 Con molle parastrappi	<b>Art. 15302</b> OEM 5.073.502 Manicotto con cuscinetto reggispinta Ø foro 33 mm (NO PER 7000) 	<b>Art. 15740</b> OEM Manicotto con cuscinetto reggispinta Ø foro 36 mm
			<b>Art. 15809</b> OEM 5108518 Disco frizione 250x155x3,5 mm 27x30 mm - Z.16 Con molle parastrappi  (SOLO PER 7000) 		
3200 - 3800 4000 - 4200	<b>Art. 15337</b> 	OEM 5.107.505 Frizione monodisco con molle a diaframma Piatto Ø 200 mm	<b>Art. 15738</b> OEM  Disco frizione 200x130x3,2 mm 35x31 mm Z.18 	<b>Art. 15302</b> OEM 5.073.502 Manicotto con cuscinetto reggispinta Ø foro 33 	<b>Art. 15740</b> OEM Manicotto con cuscinetto reggispinta Ø foro 36 mm
3700 - 5200 - 5500	<b>Art. 15338</b> 	OEM 5.107.504 Frizione monodisco con molle a diaframma Piatto Ø 215 mm	<b>Art. 15739</b> OEM  Disco frizione 215x145x3,2 mm 35x31 mm - Z.18 Con molle parastrappi 	<b>Art. 15302</b> OEM 5.073.502 Manicotto con cuscinetto reggispinta Ø foro 33 	<b>Art. 15740</b> OEM Manicotto con cuscinetto reggispinta Ø foro 36 mm
ERGIT MACH 2 MACH 4	<b>Art. Kit 16085</b> 	 	OEM 19930174  Kit meccanismo + disco PTO Ø 300 a 6 pale Z.18  	<b>Art. 16189</b>   	OEM 37115001 - 37115011  Cuscinetto Roggi Ø foro 38 mm

## CARRARO SPA - RUOTE

CARRO 335 - 400 - 445 - 500 CARRO II serie 300 - 350	<b>Art. 15355</b> 	OEM 70542 Disco rigido centrale 250x155x3,5 mm 28x23x6 mm Z.6	<b>Art. 15356</b> OEM 70541 Disco rigido presa di forza 216x152x3,5 mm 48x42x8 mm - Z.8 	<b>Art. 15759</b> 	OEM 83966 Disco frizione rigido 216x152x3,5 mm 30x26EV Z.10
CARRO 450 - 502 - 504 - 3500 - 4500 - 5000 (DOPPIA FRIZIONE)	<b>Art. 15370</b> 	OEM 83967 Disco rigido centrale 250x155x3,5 mm 30x26EV Z.10	<b>Art. 15375</b> OEM 83968 Disco rigido presa di forza 216x125x3,5 mm 48,5x42,5EV - Z.13 		
CARRO 552 - 554 - 602 - 604 - 652 - 654 - 702 - 704 - 732 - 734 - 6000	<b>Art. 15376</b> 	OEM 91932 - 107245 Disco rigido centrale 280x165x3,5 mm 30x25EV - Z.10	<b>Art. 15377</b> 		
68.2 - 68.4 - 78.2 - 78.4 - 88.2 - 88.4 - NUOVO OK: 620.2 - 620.4 - 720.2 - 720.4 - 820.2 - 820.4 - 920.2 - 920.4	<b>Art. 15806</b> 	OEM 120738 Frizione con disco PTO interno (15634) Piatto Ø 280 mm	<b>Art. 15376</b> 	<b>Art. 15586</b> 	OEM 109700 - 107245 Disco centrale rigido metalceramico Ø 280 mm sinterizzato 30x25EV - Z.10
	<b>Art. 15634</b> 	OEM 104809 Disco PTO rigido in ferodo 280x165x3,5 mm 45,5x39,5EV - Z.14	<b>Art. 15404</b> 	<b>Art. 63363</b> 	OEM  Cuscinetto PTO 100x65x18 mm
48.2 - 48.4 58.2 - 58.4	<b>Art. 15761</b> 	OEM 107247 Disco rigido centrale 260x160x3,8 mm 30x25EV - Z.10	<b>Art. 15760</b> 		
4500 - 5000 - 6500 - 7000	<b>Art. 15724</b> 	OEM Frizione monodisco a molle elicoidali Piatto Ø 280 mm (solo per 4500-5000)	<b>Art. 15762</b> 		









Gli articoli qui descritti, prodotti da e/o per conto di CERMAG, sono da intendersi adattabili, quindi non originali, ai marchi indicati secondo REG. CE 1400/2002  
All items described here, produced by and/or on behalf of CERMAG, are to be understood as adaptable, therefore not original, to the brands indicated according to REG. EC 1400/2002

# Frizioni e loro componenti







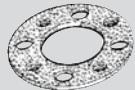

CLUTCHES - CLUTCH DISK - BEARING - COUPLING - LEVER - SET-REVISION

11

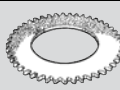





## segue CARRARO SPA - RUOTE

AGRIPUS 65-75-85-95 AGRI-UP 50-50F-60-60F-60V-70-70F-70V-70-80F-80V	<b>Art. Kit 16054</b>  	OEM 207238  Kit composto da: - Meccanismo 15946 - Disco PTO 15873 - Cuscinetti 15990 - 63895 - 64536	
	<b>Art. 15946</b>  OEM Meccanismo a 6 leve completo di disco centrale metalceramico 34x40 mm - Z12 senza disco PTO Piatto Ø 280 (11") intercambiabile con OMG	<b>Art. 15873</b>  OEM 199071 Disco PTO rigido in metalceramico. Ø 280 mm 22x19 mm - Z13	<b>Art. 15948</b>  OEM 126004 Disco PTO rigido in ferodo. Ø 280 mm 22x19 mm - Z13
	<b>Art. 15280</b>  OEM Cuscinetto reggispinta cambio 90x50x22 mm <b>Art. LUK 15990</b>	<b>Art. 63363</b>  OEM Cuscinetto PTO 100x65x18 mm <b>Art. FAG 63895</b>	<b>Art. FAG 64536</b>  OEM Cuscinetto volano 40x12x17 mm

## CARRARO SPA - CINGOLI

450 C - 450 L - 455 C - 505 C - 555 C - 655 C - 6300 C	<b>Art. 15388</b>  OEM 83793 Anello frizione cambio 88x48x4,5 mm 8 Fori	<b>Art. 15389</b>  OEM 83702 Anello frizione sterzo 229x171x2 mm 21 denti Dentatura interna	<b>Art. 15174</b>  OEM Anello frizione sterzo in conglomerato 239x180x4,8 mm 28 denti sterzi	<b>Art. 15176</b> OEM 83703 - 99425 Anello frizione di sterzo in tessuto 239x180x4,8 mm 28 denti esterni
3500 C - 4500 C	<b>Art. 15173</b>  OEM 83779 Anello frizione centrale 277x156x10 mm (1/3 T)-45 denti esterni	<b>Art. 15174</b>  OEM Anello frizione di sterzo In conglomerato 239x180x4,8 mm 28 denti esterni	<b>Art. 15176</b>  OEM 83703-99425 Anello frizione di sterzo In tessuto - 239x180x4,8 mm 28 denti esterni	
	<b>Art. 15388</b>  OEM 83793 Anello frizione cambio 88x48x4,5 mm - 8 Fori	<b>Art. 15389</b>  OEM 83702 Anello frizione sterzo 229x171x2 mm 21 denti interni		

## CASE



































SERIE 33: 533A - 540 - 633A - XE - XF - 640 - 740 - 733A (DAL MAGGIO 1978 IN AVANTI) 833A/E/H/V - 840 - 933 - 940	<b>Art. Kit 16117</b>  	OEM 1964054C1 Kit Frizione bidisco Ø 228/290 completo di: disco PTO rigido Ø 290 mm Z.13, cuscinetto 65x101,5x21,5 cuscinetto 80x137,5x41,5 cuscinetto 20x47x14	
	<b>Art. 15546</b>  OEM 3224 545 R2 1964 054 C1 Meccanismo a 6 leve completo Piatto Ø 290 mm	<b>Art. 15547</b>  OEM 1964 - 150 C1 Disco centrale metalceramico molleggiato a 6 pale Ø 290 sinterizzato-Z.13	
SERIE 55 - 56: 856XL - XLA - 955 XL - 956 XL - XLA - 1055 XL - 1056 XL - XLA	<b>Art. 15550</b>  OEM 135 508 A1 3220 807 R3 Meccanismo Ø 310 a 6 leve completo di disco PTO Ø 310 a 5 pale 45x41 mm Z.22	<b>Art. 15551</b>  OEM 1968 356 C1 3224.423 R91 Disco centrale metalceramico a 7 pale - Molleggiato Ø 310 mm sinterizzato Z.10	



# Frizioni e loro componenti

CLUTCHES - CLUTCH DISK - BEARING - COUPLING - LEVER - SET-REVISION

## segue CASE

<p>1455 XL 1255 XL</p>	<p><b>Art. Kit 16119</b></p>    <p>OEM 1964060C2</p> <p>Kit composto da: - Meccanismo 15921 - Disco PTO 15922</p>			
	<p><b>Art. 15921</b> OEM 1964060C1 3230985R98 Meccanismo Ø350 mm con disco interno 44x48 Z.23</p>  	<p><b>Art. 15922</b> OEM 196409C1 3230722R91 Disco PTO Ø 350 mm 27x30 mm Z.16</p>  	<p><b>Art. 15799</b> OEM</p>  <p>Cuscinetto reggispinta 65x102x26 mm</p>	
		<p><b>Art. 62952</b> OEM 47127081 Cuscinetto reggispinta PTO 75x115x20 mm</p>  <p><b>Art. FAG 63897</b></p>	<p><b>Art. 62583</b> OEM</p>  <p>Cuscinetto volano 20x47x14 mm</p> <p><b>Art. FAG 63869</b></p>	
<p>JX90/95 FARMALL JX100/</p>	<p><b>Art. 15876</b> OEM 47618909 5092803 Meccanismo frizione a 6 leve con disco interno a 6 pale Z.16 Piatto Ø 310 mm (12")</p>  	<p><b>Art. 15877</b> OEM 5089337</p>   <p>Disco frizione Ø 310 mm 22x25 mm - Z.10</p>	<p><b>Art. 62951</b> OEM 24905360 Cuscinetto reggispinta PTO 70x110x20 mm</p>  <p><b>Art. FAG 63896</b></p>	
	<p><b>Art. 15990</b> OEM 5119290 5119875 - 5122028 Cuscinetto reggispinta cambio 90x50x22 mm</p>  	<p><b>Art. 15280</b> OEM 5122028 Cuscinetto reggispinta cambio 90x50x22 mm</p> 	<p><b>Art. 62581</b> OEM 28043280 Cuscinetto volano 17x47x14 mm</p>  <p><b>Art. FAG 63867</b></p>	
<p>AGRIPLUS 85/95 2140 - 2150 Serie 2000</p>	<p><b>Art. Kit 16054</b></p>       <p>OEM</p> <p>Kit composto da: - Meccanismo 15946 - Disco PTO 15873 - Cuscinetti 15990 - 63895 - 54536</p>			
	<p><b>Art. 15946</b> OEM Meccanismo a 6 leve completo di disco centrale metalceramico 34x40 mm - Z12 senza disco PTO Piatto Ø 280 (11") intercambiabile con OMG</p>  	<p><b>Art. 15873</b> OEM Disco PTO rigido in metalceramico. Ø 280 mm 22x19 mm - Z13</p>  	<p><b>Art. 15948</b> OEM</p>   <p>Disco PTO rigido in ferodo. Ø 280 mm 22x19 mm - Z13</p>	
	<p><b>Art. 15280</b> OEM</p>   <p>Cuscinetto reggispinta cambio 90x50x22 mm</p> <p><b>Art. LUK 15990</b></p>	<p><b>Art. 63363</b> OEM</p>  <p>Cuscinetto PTO 100x65x18 mm</p> <p><b>Art. FAG 63895</b></p>	<p><b>Art. FAG 64536</b> OEM</p>  <p>Cuscinetto volano 40x12x17 mm</p>	

































# Frizioni e loro componenti

CLUTCHES - CLUTCH DISK - BEARING - COUPLING - LEVER - SET-REVISION

11

























## segue CASE

<p>JX 1075V</p>	<p><b>Art. Kit 16035</b></p>  		<p>OEM 73328271 Kit composto da: - Meccanismo 15793 - Disco PTO 15792 - Cuscinetti 15990 - 63897 - 63867</p>
	<p><b>Art. 15793</b></p>   <p>OEM 5196818-47134898 Meccanismo a 6 leve completo di disco centrale cerametallico 5 pale. Piatto Ø 280 mm 35x39,8 mm Z.14</p>	<p><b>Art. 15792</b></p>   <p>OEM 5176450 - 47134874 - 5196819 Disco PTO rigido in cerametallico 4 pale Ø 280 mm - 22x25 Z10</p>	
	<p><b>Art. 15990</b></p>   <p>OEM 5119290 5119875 - 5122028 Cuscinetto reggispinta cambio 90x50x22 mm</p>	<p><b>Art. 15280</b></p>  <p>OEM 5122028 87345759 Cuscinetto reggispinta cambio 90x50x22 mm</p>	
	<p><b>Art. 62952</b></p>  <p>OEM 47127081 Cuscinetto reggispinta PTO 75x115x20 mm</p> <p><b>Art. FAG 63897</b></p>	<p><b>Art. 62581</b></p>  <p>OEM 28043280 Cuscinetto volano 17x47x14 mm</p> <p><b>Art. FAG 63867</b></p>	
<p>SERIE 43 - 44: 724 (DAL MAGGIO 1978 IN AVANTI) - 734 - 743 - 744 - 745 - 754 - 824 - 834 - 844 - 845 - S/XL/XLA 523 - 553 - 554 - 564 - 624 - 644 - 654 - 724/XL/XLA - 734/XL/XLA - 743/XL/XLA - 744/XL/XLA - 745/S/XL/XLA - 754/XL/XLA - 824/S/XL/XLA - 834/S/XL/XLA - 844/S/XL/XLA/XLN - 845XL</p>	<p><b>Art. Kit 16118</b></p>  		<p>OEM Kit Frizione bidisco composto da: - Meccanismo 15548 - Disco PTO 15549 - Cuscinetti 15862 - 63897 - 63896</p>
	<p><b>Art. 15548</b></p>   <p>OEM 135 506 A1 1964 056 C1 Meccanismo a 6 leve completo di disco PTO ma senza disco centrale Piatto Ø 300 mm</p>	<p><b>Art. 15549</b></p>  <p>OEM 1964 223 C1 3225.094 R1 3225.950 R1 Disco centrale metalceramico a 5 pale - Molleggiato - Ø 295 mm sinterizzato - Z.10</p>	<p><b>Art. 62952</b></p>  <p>OEM Cuscinetto reggispinta PTO 75x115x20 mm</p> <p><b>Art. FAG 63897</b></p>
		<p><b>Art. 15862</b></p>  <p>OEM 5103178 Cuscinetto reggispinta</p>	<p><b>Art. 62549</b></p>  <p>OEM Cuscinetto PTO 20x47x14 mm</p> <p><b>Art. FAG 63836</b></p>
<p>533/A - 540 - 633A/XE/XF - 733A - 740 - 833/A/E/H/V - 833/S/XL/XLA - 933</p>	<p><b>Art. 15546</b></p>   <p>OEM 1.964054EX Meccanismo a 6 leve completo Piatto Ø 290 mm</p>	<p><b>Art. 15547</b></p>  <p>OEM Disco centrale metalceramico molleggiato a 6 pale Ø 290 sinterizzato-Z.13</p>	
<p>856XL - 955XL/XLA - 1055XL - 1056XL -</p>	<p><b>Art. Kit 16120</b></p>  		<p>OEM Kit Frizione bidisco Kit composto da: - Meccanismo 15550 - Disco 15551 cuscinetto 65x102x25 cuscinetto 75x115x20 cuscinetto 20x47x14</p>
	<p><b>Art. 15550</b></p>   <p>OEM 47512419 Meccanismo Ø 310 a 6 leve completo di disco PTO Ø 310 a 5 pale 45x41 mm Z.22</p>	<p><b>Art. 15551</b></p>  <p>OEM 1968 356 C1 3224.423 R91 Disco centrale metalceramico a 7 pale - Molleggiato Ø 310 mm sinterizzato Z.10</p>	
<p>AVJ 55/60/70 - JX 55/60/65/70</p>	<p><b>Art. 15544</b></p>   <p>OEM 47512408 - Meccanismo a 6 leve completo di disco centrale in ferodo senza il disco PTO. - Piatto Ø 280 mm (11")</p>	<p><b>Art. 15943</b></p>  <p>OEM Disco PTO rigido in ferodo 280x165x3 mm 25x22EV - Z.10</p>	

# Frizioni e loro componenti

CLUTCHES - CLUTCH DISK - BEARING - COUPLING - LEVER - SET-REVISION

## segue CASE





























JX 1070C/1075C/N/V 1085C/1095C/N/V QUANTUM 95C/F/N/V/ 105F/N	<b>Art. Kit 16036</b>  	OEM 87689675 Kit composto da: - Meccanismo 15796 - Disco PTO 15792 - Cuscinetti 15990 - 63897 - 63867	
	<b>Art. Kit 15930</b>  	OEM Kit composto da: - Meccanismo 15796 - Disco PTO 15792	
	<b>Art. 15796</b>  OEM 87732504 5181421 - 5196813 - 47134895 - 87732503 - 87732506 Meccanismo a 6 leve completo di disco centrale cerametallico 6 pale Piatto Ø 280 mm 35x39,8 mm - Z.14	<b>Art. 15990</b>  OEM 5119290 5119875 - 5122028 Cuscinetto reggispinta cambio 90x50x22 mm	<b>Art. 15280</b>  OEM 5122028 87345759 Cuscinetto reggispinta cambio 90x50x22 mm
	<b>Art. 15792</b>  OEM 5176450 - 47134874 - 5196819 Disco PTO rigido in cerametallico 4 pale Ø 280 mm - 22x25 Z10	<b>Art. 62952</b>  OEM 47127081 Cuscinetto reggispinta PTO 75x115x20 mm  <b>Art. FAG 63897</b>	<b>Art. 62581</b>  OEM 28043280 Cuscinetto volano 17x47x14 mm  <b>Art. FAG 63867</b>
JX 85/90  <b>MECCANISMO RINFORZATO</b>  N.B.: Quando si sostituisce un meccanismo non rinforzato con un meccanismo rinforzato, bisogna sostituire anche il disco PTO.	<b>Art. Kit 15929</b>  	OEM 5092796 Kit composto da: - Meccanismo 15505 - Disco PTO 15943	
	<b>Art. Kit 15938</b>  	OEM Kit composto da: - Meccanismo 15505 - Disco PTO 15943 - Cuscinetti 15990 - 63896 - 63867	
	<b>Art. 15505</b>  OEM Meccanismo a 6 leve completo di disco centrale metalceramico a 6 pale senza il disco PTO. Piatto Ø 280 mm (11") Intercambiabile con meccanismo VALEO	<b>Art. 15943</b>  OEM Disco PTO rigido in ferodo 280x165x3 mm 25x22EV - Z.10	<b>Art. 15520</b>  OEM Disco PTO rigido in ferodo 280x165x3 mm 25x22EV - Z.10
	<b>Art. 15414</b>  OEM Disco centrale metalceramico a 5 pale con molle parastrappi Ø 280 mm sinterizzato 40x35EV - Z.14 <b>Tipo SILA intercambiabile con LUK</b>	<b>Art. 15528</b>  OEM Disco centrale metalceramico a 6 pale con molle parastrappi per meccanismo 15505 Ø 280 mm sinterizzato 40x35EV - Z.14	<b>Art. 15523</b>  OEM Disco centrale in ferodo con molle parastrappi 280x165x3,5 mm 40x35EV - Z.14
	<b>Art. 15990</b>  OEM 5119875 - 5122028 Cuscinetto reggispinta cambio 90x50x22 mm	<b>Art. 15280</b>  OEM 5119875 - 5122028 Cuscinetto reggispinta cambio 90x50x22 mm	<b>Art. 62581</b>  OEM Cuscinetto volano 17x47x14 mm  <b>Art. FAG 63867</b>
			<b>Art. 62951</b>  OEM Cuscinetto reggispinta PTO 70x110x20 mm  <b>Art. FAG 63896</b>

# Frizioni e loro componenti

CLUTCHES - CLUTCH DISK - BEARING - COUPLING - LEVER - SET-REVISION

11





















## segue CASE

<p>JX 90/95/1070U/ 1080U/1090U/70U/ 80U/90U JXU 105/75/85/95/</p>	<p><b>Art. Kit 16056</b> </p>		<p>OEM</p> <p>Kit composto da: - Meccanismo 15786 - Disco PTO 15785 - Cuscinetti 15990 - 63867</p>	
	<p><b>Art. Kit 15981</b> </p>		<p>OEM</p> <p>Kit composto da: - Meccanismo 15786 - Disco PTO 15792 - Cuscinetti 15990 - 63896 - 63867</p>	
	<p><b>Art. 15786</b> </p>	<p>OEM 84478095 Meccanismo a 6 leve completo di disco centrale cerametallico 6 pale senza il disco PTO Piatto Ø 310 mm</p>	<p><b>Art. 15792</b> </p> <p>OEM Disco PTO rigido in cerametallico 4 pale Ø 280 mm - 22x25 Z10</p>	<p><b>Art. 15785</b> </p> <p>OEM Disco PTO rigido in ferodo senza molleggio Ø 310 mm - 22x25 Z10</p>
	<p><b>Art. 62951</b>  <b>Art. FAG 63896</b></p>	<p>OEM Cuscinetto reggispinta PTO 70x110x20 mm</p>	<p><b>Art. 15990</b>  </p> <p>OEM Cuscinetto reggispinta cambio 90x50x22 mm</p>	<p><b>Art. 15280</b>  </p> <p>OEM Cuscinetto reggispinta cambio 90x50x22 mm</p>
			<p><b>Art. 62952</b>  <b>Art. FAG 63897</b></p> <p>OEM 47127081 Cuscinetto reggispinta PTO 75x115x20 mm</p>	<p><b>Art. 62581</b>  <b>Art. FAG 63867</b></p> <p>OEM Cuscinetto volano 17x47x14 mm</p>
<p>JX 1060V/1070V/C/ 1075V/C/ 1085C/ 1095C/N/V JX 95 QUANTUM 105F/N/V/ 65C/N/75C/F/N/V/ 85C/F/N/V/95C/F/N/V</p>	<p><b>Art. 15797</b> </p>	<p>OEM 87590432  Meccanismo Piatto Ø 280 mm</p>	<p><b>Art. 15792</b> </p> <p>OEM  Disco PTO rigido in cerametallico 4 pale Ø 280 mm - 22x25 Z10</p>	
<p>JX 1060V/C/1070V/N - 1075N</p>	<p><b>Art. Kit 15977</b> </p>		<p>OEM 87689676</p> <p>Kit composto da: - Meccanismo 15789 - Disco PTO 15792 - Cuscinetti 15990 - 63897 - 63867</p>	
	<p><b>Art. 15789</b> </p>	<p>OEM 47134889 Meccanismo a 6 leve completo di disco centrale Piatto Ø 280 mm</p>	<p><b>Art. 15792</b> </p> <p>OEM Disco PTO rigido in cerametallico 4 pale Ø 280 mm - 22x25 Z10</p>	<p><b>Art. 15990</b>  </p> <p>OEM Cuscinetto reggispinta cambio 90x50x22 mm</p>
	<p><b>Art. 15280</b>  </p>	<p>OEM Cuscinetto reggispinta cambio 90x50x22 mm</p>	<p><b>Art. 62952</b>  <b>Art. FAG 63897</b></p> <p>OEM 47127081 Cuscinetto reggispinta PTO 75x115x20 mm</p>	<p><b>Art. 62581</b>  <b>Art. FAG 63867</b></p> <p>OEM Cuscinetto volano 17x47x14 mm</p>
<p>JX 70U</p>	<p><b>Art. 15784</b> </p>	<p>OEM 5167933 Meccanismo a 6 leve completo di disco centrale in ferodo senza il disco PTO Piatto Ø 310 mm</p>	<p><b>Art. 15785</b> </p> <p>OEM 5167937 Disco PTO rigido in ferodo senza molleggio Ø 310 mm - 22x25 Z10</p>	



# Frizioni e loro componenti

CLUTCHES - CLUTCH DISK - BEARING - COUPLING - LEVER - SET-REVISION

## segue CASE

JX 100U/1070U/1080U JXU75/85/95 PJ 55/65/75 PJN 55/65/75 P JV 55/65/75	<b>Art. Kit 16075</b>  	OEM	Kit composto da: - Meccanismo 15787 - Disco PTO 15788	
	<b>Art. 15787</b> OEM  Meccanismo Piatto Ø 310 mm	<b>Art. 15788</b> OEM  Disco di avanzamento cerametallico doppio segmento a 6 pale Ø 310 mm - 40x45 mm Z16	<b>Art. 16009</b> OEM  Manicotto con reggispinta	
QUANTUM 65C/N/75C/F/N/V/ 85C/F/N/V	<b>Art. Kit 15930</b>  	OEM 87732502	Kit composto da: - Meccanismo 15796 - Disco PTO 15792	
	<b>Art. 15796</b> OEM  Meccanismo a 6 leve completo di disco centrale cerametallico 5 pale Piatto Ø 280 mm 35x39,8 mm - Z.14	<b>Art. 15792</b> OEM  Disco PTO rigido in cerametallico 4 pale Ø 280 mm - 22x25 Z10		
MAXXUM 100-110 MXU 100-110	<b>Art. Kit 16172</b>  	OEM 5196060	Kit completo frizione Ø 330 con disco centrale a 5 pale Ø 330 Z.16 mozzo 40x45	
FARMALL 75A FARMALL 85C	<b>Art. Kit 16212</b>  	OEM 47124874 - 84342957	Kit composto da: - Meccanismo - Disco	
	<b>Art. 62952</b> OEM 47127081  Cuscinetto reggispinta PTO 75x115x20 mm <b>Art. FAG 63897</b>	<b>Art. 15280</b> OEM 87345759  Cuscinetto reggispinta cambio 90x50x22 mm <b>Art. LUK 15990</b>	<b>Art. 62580</b> OEM 87729147 - 87302841  Cuscinetto 17x40x12 mm <b>Art. FAG 63866</b>	
FARMALL 55C/65C/75C	<b>Art. Kit 16217</b>  	OEM 84233502	Kit composto da: - Meccanismo - Disco	
	<b>Art. 15280</b> OEM 87345759  Cuscinetto reggispinta cambio 90x50x22 mm <b>Art. LUK 15990</b>	<b>Art. 62952</b> OEM 47127081  Cuscinetto reggispinta PTO 75x115x20 mm <b>Art. FAG 63897</b>	<b>Art. 62580</b> OEM 87729147 - 87302841  Cuscinetto 17x40x12 mm <b>Art. FAG 63866</b>	

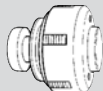
## CASORZO

MOTOFALCIATRICE (DAL 1994 IN AVANTI) MOTOZAPPA 125/125C MOTOCOLTIVATORI BRIO - GOLF	<b>Art. 15622</b> OEM  Frizione Ø 103x90 mm a dischi multipli con 4 dischi 20x16x4 mm - Z.6 Albero Ø 23 mm - Conicità 1:5		
MOTOCOLTIVATORE (DAL 1994 IN AVANTI) (MOT. 3LD 510)	<b>Art. 15623</b> OEM  Frizione Ø 103x90 mm a dischi multipli con 5 dischi 20x16x4 mm - Z.6 Albero Ø24 - Conicità 1:5	<b>Art. 15584</b> OEM  Serie dischi completa. Composta da 5 dischi di Ø 93 mm	

Gli articoli qui descritti, prodotti da e/o per conto di CERMAG, sono da intendersi adattabili, quindi non originali, ai marchi indicati secondo REG. CE 1400/2002  
 All items described here, produced by and/or on behalf of CERMAG, are to be understood as adaptable, therefore not original, to the brands indicated according to REG. EC 1400/2002















































# Frizioni e loro componenti

CLUTCHES - CLUTCH DISK - BEARING - COUPLING - LEVER - SET-REVISION

11

## CLAAS

AXOS 310C - 320C - 330C - 340C CELTIS 426RA/RC/RX - 436RA/RC/RX - 446RA/RC/RX - 456RA/RC/RX	<b>Art. Kit 16049</b>   	OEM  Kit composto da: - Meccanismo 15919 - Disco PTO 15920		
	<b>Art. 15919</b>   OEM 1118914 Meccanismo a 6 leve Ø 310 mm	<b>Art. 15920</b>   OEM Disco PTO Ø 310 mm 21,7x25 mm - Z.13	<b>Art. 15755</b>  OEM 11310930 Cuscinetto reggispinta 96,5x65x23,5 mm	
	<b>Art. 62580</b>  OEM Cuscinetto 17x40x12 mm  <b>Art. FAG 63866</b>	<b>Art. 15756</b>  OEM 11310940 Cuscinetto reggispinta PTO 106x139,5x25 mm		
ATOS 240/340/350	<b>Art. Kit 16041</b>    	OEM  Kit composto da: - Meccanismo 15923 - Disco centrale 15924 - Cuscinetto 15744		
	<b>Art. 15923</b>   OEM Meccanismo frizione con molle a diaframma Ø 330 (13")	<b>Art. 15924</b>   OEM Disco centrale a 5 pale 36,5x41 mm - Z.24	<b>Art. 15744</b>  OEM Cuscinetto reggispinta 90x55x22 mm	
NECTIS 217VE/VL NECTIS 227F/VE/VL NEXOS 220FB	<b>Art. Kit 15955</b>   	OEM 6000105767 <b>Kit Frizione bidisco</b> con meccanismo a 6 leve e disco PTO Ø 280 mm. 34x40 mm - Z.12		
	<b>Art. Kit 16055</b>    	OEM  Kit composto da: - Meccanismo 15960 - Disco 15961 - Cuscinetto 15744		
ATOS 220/230/330	<b>Art. 15960</b>   OEM Meccanismo frizione con molle a diaframma Ø 310 mm	<b>Art. 15961</b>   OEM 0.014.9016.3 0.015.2816.3  Disco Ø 310 mm	<b>Art. 15744</b>  OEM Cuscinetto reggispinta 90x55x22 mm	
NECTIS 257VL/F NECTIS 247F NECTIS 257F	<b>Art. Kit 15957</b>     	OEM 6000105784 Kit composto da: - Meccanismo - Disco frizione 15873 - Cuscinetti 63895 -		
ELIOS 210/220/230 NECTIS 237F/VE/VL NECTIS 257F/VL NECTIS 267F/VL NEXOS 210F/VE/VL NEXOS 220F/VE/VL NEXOS 230F/FB/ VE/VL	<b>Art. Kit 16105</b>   	OEM 6000105777  Kit composto da: - Meccanismo 15958 - Disco PTO 15873		
	<b>Art. 15958</b>   OEM Frizione bidisco a 6 leve Ø 280 mm con disco a 6 pale 34x40 mm - Z.12	<b>Art. 15873</b>   OEM Disco frizione rigido sinterizzato a 4 pale mozzo 22x19 mm - Z.13	<b>Art. 63363</b>  OEM Cuscinetto PTO 100x65x18 mm  <b>Art. FAG 63895</b>	



(segue CLAAS)

















# Frizioni e loro componenti

CLUTCHES - CLUTCH DISK - BEARING - COUPLING - LEVER - SET-REVISION

## segue CLAAS

<p>AXOS 310CL/CX AXOS 320CL/CX AXOS 330CL/CX AXOS 340CL/CX CELTIS 426RA/RC/RX CELTIS 436RA/RC/RX CELTIS 446RA/RC/RX CELTIS 456RA/RC/RX</p>	<p><b>Art. Kit 16106</b></p> 		<p>OEM 11380601 Kit Frizione monodisco completo di meccanismo, disco interno Ø 310 Z.13, cuscinetto 65x100x18, cuscinetto 17x40x12</p>
--	--	--	--

## DEUTZ

<p>DX 80 - DX 85/A - DX 86 - DX 90/A - DX 92 AGROPRIMA 4.31/ 4.51/4.56/6.06/ 6.16 AGROXTRA 4.47/ 4.57/6.07/6.17 DX 4.10/4.30/4.31/ 4.50/4.51/4.57H/ 4.70/5.30/5.50/5.70/ 6.05</p>	<p><b>Art. Kit 16050</b></p> 		<p>OEM Kit composto da: - Meccanismo 15568 - Disco PTO 15570 - Cuscinetti 16051 - 16052 - 63870</p>	
	<p><b>Art. 15568</b></p> 	<p>Meccanismo a 6 leve Piatto Ø 310 mm</p>	<p><b>Art. 15569</b></p> 	<p>OEM 438.6687 Disco centrale metalceramico molleggiato a 8 pale Ø 310 mm sint - Z.21</p>
	<p><b>Art. 16051</b></p> 	<p>OEM 4383378 Cuscinetto reggi spinta 97x23x65 mm</p>	<p><b>Art. 16052</b></p> 	<p>OEM 4383379 Cuscinetto reggi spinta 140x25x106 mm</p>
<p>AGROCOMPACT 80/F/V/90F/100/F70/ F75 AGROLUX 60/70/F60/ F70/F80/F100 AGROPLUS 67/70/77/ 80/87/F70/F75/F90/ F100 AGROCLIMBER F90C/F90M/F90N</p>	<p><b>Art. 15746</b></p> 	<p>OEM 0.015.9285.3 0.008.4254.3/10 Meccanismo con molla a diaframma piatto Ø 310 mm</p>	<p><b>Art. 15963</b></p> 	<p>OEM 44623.303 0.455.2330.3/10 0.015.9288.3 Disco centrale in ferodo con molle parastrappi 310x191x3,5 mm 40x36,5 mm - Z.24</p>
	<p><b>Art. 15962</b></p> 	<p>OEM 0.015.9289.3 0.014.1111.3 Disco centrale metaceramico 6 pale con parastrappi Ø310 sinterizzato 41x36 mm - Z.24</p>	<p><b>Art. 15748</b></p> 	<p>OEM 0.015.9289.3 0.014.1111.3 Disco centrale metaceramico 6 pale con parastrappi Ø310 sinterizzato 40x36,5 mm - Z.24</p>
<p>AGROCOMPACT 60F/V 70F/V AGROLUX 60/F60 AGROPLUS 60/67</p>	<p><b>Art. Kit 16038</b></p> 		<p>OEM 0.015.9287.3 Kit composto da: - Meccanismo 15439 - Disco PTO 15979 - Cuscinetti 15744</p>	
	<p><b>Art. 15439</b></p> 	<p>OEM 0.015.9287.3 255.2320.3/10 0.009.6914.3/20 Meccanismo con molle a diaframma Piatto Ø 280 mm</p>	<p><b>Art. 15979</b></p> 	<p>OEM 0.015.9286.3 Disco frizione centrale in ferodo con molle parastrappi 280x172x3,5 mm 40x36,5EV - Z.24</p>
			<p><b>Art. 15744</b></p> 	<p>Cod orig. 2.2999.475.0 Cuscinetto reggisplinta 90x55x22 mm</p>





























(segue DEUTZ)

# Frizioni e loro componenti

CLUTCHES - CLUTCH DISK - BEARING - COUPLING - LEVER - SET-REVISION

11

## segue DEUTZ

































AGROCOMPACT 80F/V/90F/F60 AGROLUX 70/F70 AUTOPLUS 70-80	<b>Art. 15420</b>  LUK	OEM 0.014.9424.3 0.008.4293.3 0.008.4254.3/10 Meccanismo con molle a diaframma Piatto Ø 310 mm	<b>Art. 15962</b>  LUK	OEM 0.015.9289.3 0.014.1111.3 Disco centrale metaceramico 6 pale con parastrappi Ø310 sinterizzato 41x36 mm - Z.24	<b>Art. 15748</b> 	OEM 0.015.9289.3 0.014.1111.3 Disco centrale metaceramico 6 pale con parastrappi Ø310 sinterizzato 40x36,5 mm - Z.24
	<b>Art. 15982</b>  LUK	OEM 0.015.9289.3 0.014.1111.3 Disco centrale metaceramico 6 pale Ø310 sinterizzato 40x36,5 mm - Z.24	<b>Art. 15895</b>  LUK	OEM 0.015.9289.3 0.014.1111.3 Disco centrale metaceramico 6 pale con parastrappi Ø310 sinterizzato 41x36,5 mm - Z.24	<b>Art. 15744</b> 	OEM 2.2999.475.0 Cuscinetto reggispinta cambio 90x55x22 mm
AGROCOMPACT 3.30F/V-3.50-3.70-3.90 AGROXTRA 3.57-4.07 D4807/C-D5006/U- D5207/C-D5206/U- D5506/U-D6007/C- D6207/C-D6507- D6907/C- DX3.65SC/VC ITRAC 2002/2003/2004	<b>Art. 15951</b>  LUK	OEM 0.294.07.38 - 4401103 Meccanismo doppio a 6 leve Ø 280 mm con disco centrale. 36x40 mm - Z.20	<b>Art. 15952</b>  LUK	OEM 02.940.363 - 2313468 Disco PTO Ø 250 mm 28x32 mm - Z.17	<b>Art. 62951</b>  <b>Art. FAG 63896</b>	OEM Cuscinetto reggispinta PTO 70x110x20 mm
	<b>Art. 62584</b>  <b>Art. FAG 63870</b>	OEM Cuscinetto 20x52x15 mm	<b>Art. 16053</b> 	OEM Cuscinetto 92x55x18,5 mm		
AGROCLIMBER 105/ 410/410six AGROFARM 100/ 100C/85C/90C/95C/ 100Ecoline/420/420T/ 430 AGROLUX 100/87/ 87LP/90/95/97/97LP/ F50 AGROPLUS 95NEW AGROTRAC 100/110 5100C/G - 5105.4G - 5115.4G - 5110C	<b>Art. Kit 16041</b>  LUK	 LUK	 LUK	 LUK	OEM  Kit composto da: - Meccanismo 15923 - Disco PTO 15924 - Cuscinetti 15744	
	<b>Art. 15923</b>  LUK	OEM Meccanismo frizione con molle a diaframma Ø 330 (13")	<b>Art. 15924</b>  LUK	OEM Disco centrale a 5 pale 36,5x41 mm - Z.24	<b>Art. 15744</b> 	OEM Cuscinetto reggispinta 90x55x22 mm
AGROCLIMBER F110MN/F90CMN/ 400F/410/F/410SIX AGROFARM 410/85/ 85 Ecoline/410T Eco./ 420T Eco./410T/ 410TB/420TB AGROLUX 80/85 AGROPLUS 100S/70S/75S/90S/ F100/F70/F75/F90/ 315/ 320/V/330V/ 410/F/V/ 420FV/ 430V 5090C/D - 5090.4D - 5080G/D - 5090G - 5090.4G	<b>Art. Kit 16055</b>  LUK	 LUK	 LUK	 LUK	OEM  Kit composto da: - Meccanismo 15960 - Disco PTO 15961 - Cuscinetti 15744	
	<b>Art. 15960</b>  LUK	OEM Meccanismo frizione con molle a diaframma Ø 310 mm	<b>Art. 15961</b>  LUK	OEM 0.014.9016.3 0.015.2816.3  Disco Ø 310 mm	<b>Art. 15744</b> 	OEM Cuscinetto reggispinta 90x55x22 mm
AGROKID 30/35/40/ 45/50/55/210/220/ 230	<b>Art. Kit 15987</b>  LUK	 LUK	 LUK	OEM 0.012.5851.4/20	Kit frizione doppia a 6 leve composto da: - disco interno a molle Ø 225 mm Z. 19 - disco PTO rigido Ø 225 mm Z. 12	

(segue DEUTZ)

# Frizioni e loro componenti

CLUTCHES - CLUTCH DISK - BEARING - COUPLING - LEVER - SET-REVISION

## segue DEUTZ









AGROLUX 4.75/E/ 410 AGROPLUS F70/410/	<b>Art. Kit 16107</b> 	 	OEM 0.017.7889.4 KIT meccanismo con disco Ø 330 mm	
AGROLUX F57	<b>Art. Kit 16044</b> 	    	OEM  Kit Frizione con meccanismo a 6 leve disco PTO, disco centrale e cuscinetti Piatto Ø 250 mm.	
	<b>Art. 15395</b> 	OEM Meccanismo a 6 leve completo di disco centrale in ferodo senza il disco PTO Piatto Ø 250 mm (11")	<b>Art. 15804</b>  OEM Disco PTO rigido in ferodo 225x145x3,5 mm 25x22EV - Z.14	
AGROSUN 100/120/ 140 AGROTAC 110	<b>Art. Kit 15394</b> 	 	OEM  KIT meccanismo presa di movimento con disco	<b>Art. 15293</b>  OEM Disco centrale metalceramico a 7 pale Rigido Ø 350 mm sinterizzato 50x45EV - Z.24
AGROCLIMBER V70C/ V70N/V80L/ V80M AGROPLUS 420F Ecoline	<b>Art. 15722</b> 	OEM Meccanismo a 6 leve. Piatto Ø 280 mm (11")	<b>Art. 15397</b>  OEM Disco centrale rigido in ferodo 280x165x3,5 mm 40x36EV - Z.20	<b>Art. 15121</b>  OEM Disco PTO rigido, in ferodo 280x165x3,5 mm 25x22EV - Z.14
AGROLUX 57/F57/F67 AGROPLUS Keyline 405F AGROPLUS Ecoline 310/F/315/F/320/F/ 405F/410F	<b>Art. 15916</b> 	OEM Meccanismo a 6 leve completo di disco Ø 280 mm	<b>Art. 15917</b>  OEM Disco Ø 280 mm 22x25 mm - 14 cave	
AGROLUX 80/90	<b>Art. 15985</b> 	OEM Meccanismo frizione con molle a diaframma Ø 350 mm	<b>Art. 15984</b>  OEM Disco PTO 6 pale Ø 330 mm 36x40 mm - Z24	
AGROLUX 90 AGROPLUS 75/85/ 95/100	<b>Art. 15954</b> 	OEM 0.010.6912.3/10 0.015.6386.3 Meccanismo con molle a diaframma Piatto Ø 350 mm	<b>Art. 15953</b>  OEM 0.007.7929.3/10 0.015.6328.3 Disco Ø 350 mm 36,5x41 mm - Z.24	<b>Art. 15983</b>  OEM 0.007.7930.3/10  Disco Ø 350 mm 41x45 mm - Z.21
	<b>Art. 16010</b> 	OEM 0.015.6381.3 Disco Ø 330 mm 36,5x41 mm - Z.24	<b>Art. 15744</b>  OEM 2.2999.475.0 Cuscinetto reggispinta 90x55x22 mm	
AGROLUX 55/60/65/ 70/75/310/320 AGROMAXX 55/60/ 4055/4060 AGROPLUS F Keyline Serie 3E/4E/4EF/5D	<b>Art. Kit 16218</b> 	    	OEM 9.J1424.00.9 - 0.015.4708.3/10  Kit Frizione con meccanismo a 6 leve disco e cuscinetti. Piatto Ø 280 mm.	

# Frizioni e loro componenti







CLUTCHES - CLUTCH DISK - BEARING - COUPLING - LEVER - SET-REVISION

11



## DIESSE

MT2 ERCOLE ORSETTO ERCOLINO	<b>Art. 15339</b>  Frizione bidisco con molle a diaframma completa di disco centrale Piatto Ø 110 mm	<b>Art. 15019</b>  Disco frizione rigido in ferodo 110x58x3 mm 15x12EV - Z.8	<b>Art. 15042</b>  OEM Manicotto con cuscinetto reggispinta
MT2 ORSETTO	<b>Art. 15321</b>  OEM Frizione monodisco con molle a diaframma Piatto Ø 95 mm	<b>Art. 15189</b>  OEM Disco frizione rigido 94x61x1,5 mm 15x12EV - Z.8	<b>Art. 15042</b>  OEM Manicotto con cuscinetto reggispinta
MOTAZAPPA 2 ORSETTO	<b>Art. 15834</b>  OEM Frizione Ø 103x67,5 mm a dischi multipli con 4 dischi 12x15EV - Z.8 Albero Ø 23 mm	<b>Art. 15630</b>  OEM Disco frizione sinterizzato Ø 93 mm	

## DISALCAR

TRANSPORTER 20HP	<b>Art. 15296</b>  OEM Meccanismo monodisco a molle elicoidali Piatto Ø 184 mm	<b>Art. 15031</b>  OEM Disco frizione rigido 180x127x3,8 mm 23x20EV Z.20	
TRANSPORTER 30HP	<b>Art. 15716</b>  OEM Frizione monodisco con molle elicoidali Piatto Ø 215 mm	<b>Art. 15099</b>  OEM Disco frizione rigido 215x152x3,8 mm 23x20EV - Z.20	
TRANSPORTER 30HP	<b>Art. 15149</b>  OEM Frizione monodisco con molle elicoidali Piatto Ø 215 mm	<b>Art. 15099</b>  OEM Disco frizione rigido 215x152x3,8 mm 23x20EV - Z.20	

## ERREPI















TRANSPORTER MOTOAGRICOLE	<b>Art. 15298</b>  OEM Frizione monodisco con molle a diaframma Piatto Ø 160 mm	<b>Art. 15029</b>  OEM Disco frizione rigido 160x110x3,8 mm 23x20EV Z.20	<b>Art. 15043</b>  OEM Manicotto con cuscinetto reggispinta
-----------------------------	--	---	---

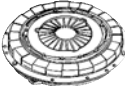

# Frizioni e loro componenti

CLUTCHES - CLUTCH DISK - BEARING - COUPLING - LEVER - SET-REVISION

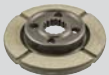
## EUROGARDEN

MOTOZAPPA E MOTOCOLTIVATORI JOLLY (DAL 1992 IN AVANTI)		<b>Art. 15588</b> OEM Frizione monodisco con molle a diaframma Piatto Ø 90 mm Albero Ø 22,5 mm Conicità 1:5 15x12EV - Z.8	<b>Art. 15525</b> OEM Disco frizione rigido in ferodo - 86x50x3,5 mm 15x12EV - Z.8		<b>Art. 15189</b> OEM Disco frizione rigido in ferodo - 94x60x3 mm 15x12EV - Z.8
			<b>Art. 15763</b> OEM Disco frizione rigido in ferodo 89x55x11 mm 15x12EV - Z.8  Ricambio per frizione 15588		
MOTOZAPPA E MOTOCOLTIVATORI TUCANO		<b>Art. 15624</b> OEM Friz. Ø103x70,5 mm a dischi multipli con 4 dischi Albero Ø 23 mm Conicità 1:5 15x12 - Z.8	<b>Art. 15625</b> OEM Serie dischi completa composta da 4 dischi di Ø 93 mm		<b>Art. 15629</b> OEM Manicotto con cuscinetto reggispinta
MOTOZAPPA LASER 2ª SERIE (DAL 1992 IN AVANTI)		<b>Art. 15613</b> OEM Frizione conica Ø 103x105,5 mm Albero Ø 22,5 mm Conicità 1:5 17x14EV - Z.9			
MOTOCOLTIVATORI TITANO (FINO AL 08/1993)		<b>Art. 15002</b> OEM Frizione monodisco con molle a diaframma Piatto Ø 110 mm	<b>Art. 15022</b> OEM Disco frizione rigido in sinterizzato 110x75x3 mm 15x12EV - Z.8		<b>Art. 15042</b> OEM Manicotto con cuscinetto reggispinta
MOTOCOLTIVATORI TITANO (DAL 09/1993 IN AVANTI)		<b>Art. 15615</b> OEM Frizione monodisco con molle a diaframma Piatto Ø 120 mm	<b>Art. 15616</b> OEM Disco frizione rigido in sinterizzato 120x90x3,5 mm 15x12EV Z.8		<b>Art. 15042</b> OEM Manicotto con cuscinetto reggispinta
MOTOCOLTIVATORI TITANO (FINO AL 04/1994)		<b>Art. 15339</b> OEM Frizione bidisco con molle a diaframma Piatto Ø 110 mm	<b>Art. 15022</b> OEM Disco frizione rigido in sinterizzato 110x75x3 mm 15x12EV Z.8		<b>Art. 15042</b> OEM Manicotto con cuscinetto reggispinta
MOTOZAPPA LASER 2ª SERIE (DAL 1993 IN AVANTI)		<b>Art. 15614</b> OEM Frizione conica Ø 104 mm Albero Ø 19,5 mm Conicità 1:5 17x14EV - Z.9			
MOTOCOLTIVATORI TITANO - CAIMANO (DAL 05/1994 IN AVANTI)		<b>Art. 15617</b> OEM Frizione bidisco completa di disco centrale Piatto Ø 120 mm	<b>Art. 15616</b> OEM Disco frizione rigido in sinterizzato 120x90x3,5 mm 15x12EV Z.8		<b>Art. 15042</b> OEM Manicotto con cuscinetto reggispinta
MOTOCOLTIVATORI REKORD		<b>Art. 15608</b> OEM Disco frizione rigido in ferodo 122x80x11,5 mm 28x25EV - Z.15			
MOTOCOLTIVATORE EURO 90		<b>Art. 15717</b> OEM Frizione conica Ø 103x79 Albero Ø 23 mm Conicità 1:5 15x12 mm - Z.8			
MOTOCOLTIVATORE EURO 90 (attacco Ø19,05)		<b>Art. 15718</b> OEM Frizione conica Ø 103x76,5 Albero Ø 19,05 Conicità 1:5 15x12 mm - Z.8			









# Frizioni e loro componenti













CLUTCHES - CLUTCH DISK - BEARING - COUPLING - LEVER - SET-REVISION

11

## EUROSYSTEMS

MOTAZAPPA (DIESEL)	<b>Art. 15719</b> 	Frizione conica Ø 103x100 Albero Ø 23 mm Conicità 1:5 15x12 mm - Z.8		
MOTAZAPPA (BENZINA)	<b>Art. 15001</b> 	Frizione conica Ø 103x100 mm Albero Ø 22,5 mm Conicità 1:5 15x12EV - Z.8		
MOTAZAPPA MOTOCOLTIVATORI	<b>Art. 15589</b> 	Frizione Ø 103x99 mm a dischi multipli con 4 dischi 15x12EV - Z.8 Albero Ø 23 mm Conicità 1.5		
TRATTORINO FLORIDA	<b>Art. 15013</b> 	OEM  Frizione monodisco con molle a diaframma Piatto Ø 160 mm	<b>Art. 15030</b> 	OEM  Disco frizione rigido 160x110x3,8 mm 17x14EV Z.9
			<b>Art. 15043</b> 	OEM  Manicotto con cuscinetto reggispinta





















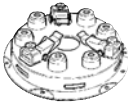

## FENDT

FARMER 206F/FA/S/V/VA - 207F/FA/S/V/VA - 208F/FA/S/V/VA - 209F/FA/S/V/VA -	<b>Art. Kit 16111</b> 		OEM E210.10.3100.040 Kit Frizione bidisco Ø 295/330 completo di: disco PTO rigido Ø 320 mm Z.10, cuscinetto 45x75x16 cuscinetto 64,5x100x30 cuscinetto 106x140x21 cuscinetto 20x42x12
FARMER 240S - 250S/V - 260P/S/V	<b>Art. Kit 16112</b> 		OEM E205.100.100.010 Kit Frizione bidisco Ø 265/250 completo di: disco PTO rigido Ø 250 mm Z.10, cuscinetto 40x68x15 cuscinetto 65x97x19 cuscinetto 106x140x21 cuscinetto 20x52x15
FARMER 260P/S - 270P/V - 275S/V - 280P (fino a telaio 248/1413)	<b>Art. Kit 16113</b> 		OEM Kit Frizione bidisco Ø 280/295 completo di: disco PTO rigido Ø 295 mm Z.10, cuscinetto 40x68x15 cuscinetto 65x97x19 cuscinetto 106x140x21 cuscinetto 20x52x15
FARMER 260V - 270P/V - 275S/V - 280P/S/V (da telaio 248/1414)	<b>Art. Kit 16114</b> 		OEM Kit Frizione bidisco Ø 280/295 completo di: disco PTO rigido Ø 295 mm Z.10, cuscinetto 40x68x15 cuscinetto 65x97x19 cuscinetto 106x140x21 cuscinetto 20x52x15
FARMER 303 - 304LS/S - 305LS/S - 306LS/S - 307Ci/LS/LSA - 308Ci/LS/LSA/S - 309Ci/LS/LSA/S - 310LS/LSA - 311LS/LSA - 312LS/LSA	<b>Art. Kit 16115</b> 		OEM Kit Frizione monodisco Ø 330 completo di: disco PTO rigido Ø 330 mm Z.10, cuscinetto 64,5x100x30 cuscinetto 20x42x12
FAVORIT 611LSA - 612LSA - 614LSA - 615LSA	<b>Art. Kit 16116</b> 		OEM Kit Frizione monodisco Ø 360 completo di: disco PTO a 6 pale Ø 360 mm cuscinetto 60x104x53 cuscinetto 40x68x15

# Frizioni e loro componenti

CLUTCHES - CLUTCH DISK - BEARING - COUPLING - LEVER - SET-REVISION

## FERRARI

MOTOCOLTIVATORI 71 (1ª SERIE)	<b>Art. 15002</b>  OEM 81.9220.000 Frizione monodisco con molla a diaframma Piatto Ø 110 mm	<b>Art. 15019</b>  OEM 81.9221.00 Disco frizione rigido 110x58x1,5 mm 15x12EV - Z.8	<b>Art. 15057</b>  OEM Leva a forcella
	<b>Art. 15050</b>  OEM Cuscinetto reggispinta	<b>Art. 15042</b>  OEM Manicotto con cuscinetto reggispinta	
MOTOCOLTIVATORI 71 (2ª SERIE)	<b>Art. 15001</b>  Frizione conica Ø 103x100 mm Albero Ø 22,5 mm Conicità 1:5 15x12EV - Z.8		
MOTOCOLTIVATORI MC 64	<b>Art. 15003</b>  OEM 81.9302.00 Frizione monodisco a molle elicoidali Piatto Ø 140 mm	<b>Art. 15021</b>  OEM Disco frizione rigido 140x96x3,8 mm 17x14x4 Z.6	
MOTOCOLTIVATORI SERIE 90	<b>Art. 15527</b>  Frizione Ø 103x99 mm A dischi multipli con 5 dischi 15x12EV - Z.8 Albero Ø 23 mm Conicità 1:5	<b>Art. 15625</b>  OEM Serie dischi completa composta da 4 dischi di Ø 93 mm	
MOTOCOLTIVATORI 72 (1ª SERIE) MOTOCOLTIVATORI MC68	<b>Art. 15003</b>  OEM 81.9302.00 Frizione monodisco a molle elicoidali Piatto Ø 140 mm	<b>Art. 15020</b>  OEM 81.9033.00 Disco frizione rigido 140x96x3,8 mm 17x15EV - Z.20	
	<b>Art. 15044</b>  OEM 81.9056.00 Manicotto con anello in grafite		
MOTOCOLTIVATORI 72 (2ª SERIE)	<b>Art. 15004</b>  OEM 81.9306.10 Frizione monodisco a molle elicoidali Piatto Ø 160 mm	<b>Art. 15028</b>  OEM 81.9304.20 Disco frizione rigido 160x112x3 mm 17x15EV - Z.20	<b>Art. 15067</b>  OEM 81.9304.30 Leva a forcella
	<b>Art. 15051</b>  OEM 81.9305.30 Cuscinetto reggispinta	<b>Art. 15048</b>  OEM 81.9305.10 Manicotto	
TRATTORINI 72T	<b>Art. 15004</b>  OEM 81.9308.010 Frizione monodisco a molle elicoidali Piatto Ø 160 mm	<b>Art. 15028</b>  OEM 81.9304.20 Disco frizione rigido 160x112x3 mm 17x15EV - Z.20	<b>Art. 15067</b>  OEM 81.9304.30 Leva a forcella
	<b>Art. 15051</b>  OEM 81.9305.20 Cuscinetto reggispinta	<b>Art. 15048</b>  OEM 81.9305.10 Manicotto	

























(segue FERRARI)

# Frizioni e loro componenti

CLUTCHES - CLUTCH DISK - BEARING - COUPLING - LEVER - SET-REVISION

11



















## segue FERRARI

MOTOCOLTIVATORI 74 - TRATTORINI 74-75 (1ª SERIE)	<b>Art. 15012</b>  OEM 81.9134.00 Frizione monodisco con molle a diaframma Piatto Ø 180 mm Ø foro diaframma 30 mm	<b>Art. 15031</b>  OEM 81.9134.20 Disco frizione rigido 180x127x3,8 mm 23x20EV Z.20	
	<b>Art. 15043</b>  OEM 81.9134.30 Manicotto con cuscinetto reggispinta	<b>Art. 15065</b>  OEM 81.9134.00 Leva a forcella	
TRATTORINO 76 MA 45/R	<b>Art. 15014</b>  OEM 81.9134.60 Frizione monodisco con molle a diaframma Piatto Ø 180 mm Ø foro diaframma 30mm	<b>Art. 15031</b>  OEM 81.9134.020 Disco frizione rigido 180x127x3,8 mm 23x20EV - Z.20	<b>Art. 15043</b>  OEM 81.9134.30 Manicotto con cuscinetto reggispinta
TRATTORINO 75 (2ª SERIE) - 94 - 95	<b>Art. 15015</b>  OEM Frizione monodisco con molle a diaframma Piatto Ø 180 mm Ø foro diaframma 36mm	<b>Art. 15031</b>  OEM 81.9134.20 Disco frizione rigido 180x127x3,8 mm 23x20EV - Z.20	<b>Art. 16209</b>  OEM <b>new</b> Cuscinetto appoggio bombato 27x70x45
MOTOCOLTIVATORI MC58 - MC60/2 - TRATTORINI MT65 (1ª SERIE)	<b>Art. 15006</b>  OEM Frizione monodisco con molle elicoidali Piatto Ø 187 mm	<b>Art. 15036</b>  OEM 101342 Disco frizione rigido 184x127x3,8 mm 29x23X4,5 - Z.10	
	<b>Art. 15055</b>  OEM 81.2878.00 Cuscinetto reggispinta	<b>Art. 15049</b>  OEM Manicotto con molla	
TRATTORINI MT65 (2ª SERIE)	<b>Art. 15149</b>  OEM Frizione monodisco con molle elicoidali Piatto Ø 215 mm	<b>Art. 15202</b>  OEM 715208 Disco frizione rigido 216x152x3,8 mm 29x23x4,5 - Z.10	
	<b>Art. 15055</b>  OEM 81.2878.00 Cuscinetto reggispinta	<b>Art. 15049</b>  OEM Manicotto con molla	
TRATTORI 95 - 95 RS - TRANSPORTER 933  (doppia frizione)	<b>Art. 15720</b>  OEM 0819180090 Meccanismo a 3 leve completo di disco centrale in ferodo. Piatto Ø 180 mm	<b>Art. 15263</b>  OEM 819160020 Disco frizione rigido PTO 180x126x3,2 mm 17x15EV - Z.20	<b>Art. 15721</b>  OEM Disco frizione centrale 180x126x3,2 mm 35x31EV Z.18
			<b>Art. 15272</b>  OEM 81.9160.030 Cuscinetto reggispinta 82x50x28
VIPER 30 AR/RS VIPER 40 AR/RS	<b>Art. Kit 16082</b>    OEM  Kit meccanismo più disco frizione. Piatto Ø 180 mm		

# Frizioni e loro componenti

CLUTCHES - CLUTCH DISK - BEARING - COUPLING - LEVER - SET-REVISION

## FIAT RUOTE - NEW HOLLAND

18 LA PICCOLA - 200 - 211R - 213 R - 241 R - 251 D - 215 R (FINO A TELAIO 313566) - 220 C	<b>Art. 15296</b>  OEM 4023341 Frizione monodisco con molle elicoidali Piatto Ø 187 mm	<b>Art. 15101</b>  OEM 594806 Disco rigido frizione 184x127x3,3 mm 22x18x3,5 Z.10	
	<b>Art. 15052</b>  OEM 5119290 Cuscinetto reggispinta 68x36x19 mm	<b>Art. 15047</b>  OEM 5119288 Manicotto	
25R - 25RS - 25CI - CP - CSI (TIPO A PEDALE) - 215R (DAL TELAIO 313667) 311-312-315N-331R	<b>Art. 15149</b>  OEM 558106 - 595731- 5134614 Frizione monodisco con molle elicoidali Piatto Ø 215 mm	<b>Art. 15027</b>  OEM 594614-595725 Disco frizione rigido in ferodo 216x152x3,5 mm 22x18x3,5 mm Z.10	<b>Art. 15052</b>  OEM Cuscinetto reggispinta 68x36x19 mm
			<b>Art. 15047</b>  OEM 5119288 Manicotto
250 - 255 C - 300	<b>Art. 15149</b>  OEM 558106 - 595731- 5134614 Frizione monodisco con molle elicoidali Piatto Ø 215 mm	<b>Art. 15148</b>  OEM 4968661 - 5134615 - 5160429 Disco frizione rigido in ferodo 216x152x3,3 25x22EV - Z.10	
	<b>Art. 15052</b>  OEM 5119290 Cuscinetto reggispinta 68x36x19 mm	<b>Art. 15047</b>  OEM 5119288 Manicotto	
311R - 312 - 315 - 331R - 411R - 415 - 431R FRIZIONE DOPPIA	<b>Art. 15104</b>  OEM 594915-4968740 Disco centrale rigido in ferodo 230x160x3,3 mm 40x35EV - Z.14	<b>Art. 15105</b>  OEM 594916-4968742 Disco PTO rigido in ferodo 230x160x3,3 mm 22x18x3,5 - Z.10	<b>Art. 15861</b>  OEM 894827 Cuscinetto reggispinta
350 - 400 - 411 - 415 - 415 DT - 431 - FRIZIONE MONODISCO	<b>Art. 15345</b>  OEM 4960118-546051 Frizione monodisco con molle elicoidali Piatto Ø 250 mm	<b>Art. 15234</b>  OEM 553914 Disco frizione rigido in ferodo 250x155x4,3 mm 35x29x5,5 mm Z.10	<b>Art. 15365</b>  OEM Cuscinetto reggispinta
			<b>Art. 15364</b>  OEM Manicotto

































(segue FIAT RUOTE -  
NEW HOLLAND)



# Frizioni e loro componenti

CLUTCHES - CLUTCH DISK - BEARING - COUPLING - LEVER - SET-REVISION

## FIAT RUOTE - NEW HOLLAND

420 - 450 - 450R - 480 - 500 - 540	<b>new Art. 16214</b> 	OEM 5161246 Meccanismo frizione a 3 leve <b>con bordino</b> 250 mm	<b>new Art. 16215</b> 	OEM 4987712-4974472 Meccanismo frizione a 3 leve <b>senza bordino</b> 250 mm	<b>Art. 15107</b> 	OEM 4968736-4994353 Disco PTO rigido in ferodo 254x164x3,5 mm 25x22EV - Z.10	
	<b>Art. 15179</b> 	OEM 4970720-4968733 Disco centrale rigido in ferodo 254x164x3,5 mm 40x35EV - Z.14	<b>Art. 15106</b> 	OEM 5109828-5161247 Disco centrale rigido in ferodo 254x164x3,8 mm 40x35EV - Z.14	<b>Art. 15862</b> 	OEM 5103178 Cuscinetto reggispinga	
35/66	<b>Art. Kit 16030</b> 			OEM 44907618  Kit composto da: - Meccanismo 15867 - Disco PTO 15868			
	<b>Art. 15867</b> 	OEM 44907615 Meccanismo a 6 leve completo di disco di avanzamento 31x35 - Z.18 Piatto Ø 230 mm	<b>Art. 15868</b> 	OEM 44907617 Disco PTO Ø 225 mm 14,4x17 - Z.9	<b>Art. 63363</b> 	OEM 24905350 Cuscinetto PTO 100x65x18 mm	
	<b>new Art. 16168</b> 	OEM 5124762 Collare	<b>Art. 15990</b> 	OEM 5119290 5119875 - 5122028 - 87345759 Cuscinetto reggispinga cambio 90x50x22 mm	<b>Art. 15280</b> 	OEM 5119290 - 5119875 - 5122028 - 87345759 Cuscinetto reggispinga cambio 90x50x22 mm	
45.66S/DT/N/V - 45.76V - 50.66N/S/DT/V - 50.86V/S/DT - 55.86FV/S/DT 45.76V - 55.76FV/DT - 55.66FV/DT - 386 - 3435 - 3830 - 3935 FORD 3435 - 3830 - 3935	<b>Art. Kit 16032</b> 						OEM Kit composto da: - Meccanismo 15552 - Disco PTO 15971 - Cuscinetti 15990 - 63895 - 63867
	<b>Art. Kit 16031</b> 			OEM  Kit composto da: - Meccanismo 15552 - Disco PTO 15971			
	<b>Art. 15552</b> 	OEM 5138144-5154513- 5171493-5139339 Meccanismo a 6 leve completo di disco centrale in ferodo, senza il disco di PTO Piatto Ø 250 mm (10") Intercambiabile con meccanismo VALEO	<b>Art. 15971</b> 	OEM 5128074-5154799 Disco PTO rigido in ferodo 250x155x3,5 mm 22x19EV - Z.13	<b>Art. 15554</b> 	OEM 5128074-5154799 Disco PTO rigido in ferodo 250x155x3,5 mm 22x19EV - Z.13	
	<b>new Art. 16168</b> 	OEM 5124762 Collare	<b>Art. 15553</b> 	OEM 5127508-5169423 Disco centrale in ferodo con molle parastrappi 250x155x4 mm 35x31EV - Z.18	<b>Art. 62581</b> 	OEM 28043280 Cuscinetto volano 17x47x14 mm	
	<b>Art. 63363</b> 	OEM 24905350 Cuscinetto PTO 100x65x18 mm	<b>Art. 15990</b> 	OEM 5119290 5119875 - 5122028 - 87345759 Cuscinetto reggispinga cambio 90x50x22 mm	<b>Art. 15280</b> 	OEM 5119290 - 5119875 - 5122028 - 87345759 Cuscinetto reggispinga cambio 90x50x22 mm	



























(segue FIAT RUOTE -  
NEW HOLLAND)



# Frizioni e loro componenti

CLUTCHES - CLUTCH DISK - BEARING - COUPLING - LEVER - SET-REVISION

## segue FIAT RUOTE - NEW HOLLAND



















<p>446 - 466 - 566 - 666 55.46 - 55.56 - 55.66 55.90 - 60.46 - 60.56 60.66 - 60.90 - 65.46 65.56 - 65.66 - 65.90 70.56 - 70.66 - 80.66</p>	<p><b>Art. Kit 15976</b></p>       <p>OEM 87689657</p> <p>Kit composto da: - Meccanismo 15544 - Disco PTO 15943 - Cuscinetti 15990 - 63896 - 63867</p>		
<p><b>Art. 15544</b></p>  <p>OEM 5145706 - 5154879 - 5171137 - Meccanismo a 6 leve completo di disco centrale in ferodo senza il disco PTO. - Piatto Ø 280 mm (11")</p>	<p><b>Art. 15943</b></p>  <p>OEM 5145715 - 5154703 Disco PTO rigido in ferodo 280x165x3 mm 25x22EV - Z.10</p>	<p><b>Art. 15520</b></p>  <p>OEM 5145715 - 5154703 Disco PTO rigido in ferodo 280x165x3 mm 25x22EV - Z.10</p>	
<p><b>Art. 15147</b></p>  <p>OEM 5171053 - 5155304 Disco centrale in ferodo con molle parastrappi 280x165x4,4 mm 40x35EV - Z.14</p>	<p><b>Art. 15990</b></p>  <p>OEM 5119290 5119875 - 5122028 - 87345759 Cuscinetto reggispinta cambio 90x50x22 mm</p>	<p><b>Art. 15280</b></p>  <p>OEM 5119290 - 5119875 - 5122028 - 87345759 Cuscinetto reggispinta cambio 90x50x22 mm</p> <p><b>Art. 15800</b> Nuova Versione OEM 5197980</p>	
	<p><b>Art. 62951</b></p>  <p>OEM 24905360 - 84455696 Cuscinetto reggispinta PTO 70x110x20 mm</p> <p><b>Art. FAG 63896</b></p>	<p><b>Art. 62581</b></p>  <p>OEM 28043280 Cuscinetto volano 17x47x14 mm</p> <p><b>Art. FAG 63867</b></p>	
<p>TCE 40 - 50 - 55</p>	<p><b>Art. Kit 15899</b></p>    <p>OEM 87291158 - 9976054</p> <p>Kit composto da: - Meccanismo - Disco PTO 15906</p>		
<p><b>Art. 15906</b></p>  <p>OEM Disco frizione interno 27x30 mm - Z.16</p>	<p><b>Art. 15907</b></p>  <p>OEM Disco PTO 14x17 - Z.9</p>	<p><b>Art. 63363</b></p>  <p>OEM Cuscinetto PTO 100x65x18 mm</p> <p><b>Art. FAG 63895</b></p>	
<p><b>Art. 15990</b></p>  <p>OEM Cuscinetto reggispinta cambio 90x50x22 mm</p>	<p><b>Art. 15280</b></p>  <p>OEM 5119290 - 5119875 - 5122028 - 87345759 Cuscinetto reggispinta cambio 90x50x22 mm</p>	<p><b>Art. 62577</b></p>  <p>OEM Cuscinetto volano 15x35x11 mm</p> <p><b>Art. FAG 63863</b></p>	
<p>T3040 TCE55</p> <p><b>new</b></p> <p>(segue FIAT RUOTE - NEW HOLLAND)</p>	<p><b>Art. Kit 16203</b></p>    <p>OEM</p> <p>Kit composto da: - Meccanismo - Disco PTO 15907</p>		

# Frizioni e loro componenti

CLUTCHES - CLUTCH DISK - BEARING - COUPLING - LEVER - SET-REVISION

11

## segue FIAT RUOTE - NEW HOLLAND

R450S 446 - 466 - 480 500 - 540 - 550 - 566 - 570 - 580 600 - 640 - 666TD - 670 - 680 55.46 - 55.56 - 55.66 - 55.90 60.46 - 60.56 - 60.66 - 60.90 - 65.46 - 65.56 - 65.66 - 65.90 70.56 - 70.66 - 70.90 80.66	<b>Art. Kit 15975</b>      	OEM 87689655  Kit composto da: - Meccanismo 15929 - Disco PTO 15943 - Cuscinetti 15990 - 63896 - 63867	
	<b>Art. 15529</b>  OEM 5154835 Meccanismo a 6 leve completo di disco centrale rigido in ferodo. Fornito senza il disco PTO. Piatto Ø 280 mm (11") Intercambiabile con meccanismo VALEO	<b>Art. 15943</b>  OEM 5145715 - 5154703 Disco PTO rigido in ferodo 280x165x3 mm 25x22EV - Z.10	<b>Art. 15520</b>  OEM 5145715 - 5154703 Disco PTO rigido in ferodo 280x165x3 mm 25x22EV - Z.10
	<b>Art. 15631</b>  OEM 5145714 - 5155300 Disco centrale rigido in ferodo 280x165x4,4 mm 40x35EV - Z.14	<b>Art. 15990</b>  OEM 5119290 5119875 - 5122028 - 87345759 Cuscinetto reggispinta cambio 90x50x22 mm	<b>Art. 15280</b>  OEM 5119290 - 5119875 - 5122028 - 87345759 Cuscinetto reggispinta cambio 90x50x22 mm  <b>Art. 15800</b> Nuova Versione OEM 5197980
	<b>Art. 15862</b>  OEM 5103178 Cuscinetto reggispinta	<b>Art. 62951</b>  <b>Art. FAG 63896</b> OEM 24905360 - 84455696 Cuscinetto reggispinta PTO 70x110x20 mm	<b>Art. 62581</b>  <b>Art. FAG 63867</b> OEM 28043280 Cuscinetto volano 17x47x14 mm
	<b>new Art. 16167</b>  OEM 4993817 Collare	<b>Art. 15863</b>  OEM 599930 Cuscinetto reggispinta	<b>Art. 15751</b>  OEM 26794570 Cuscinetto PTO 65x100x11 mm  <b>Per mod: 480 - 500 - 540 - 550 - 600 - 640</b>

(segue FIAT RUOTE - NEW HOLLAND)

# Frizioni e loro componenti

























CLUTCHES - CLUTCH DISK - BEARING - COUPLING - LEVER - SET-REVISION

## segue FIAT RUOTE - NEW HOLLAND

440-446-450-480-500-540-566-570-580-600-640-666-670-680-766-780-55.48-55.60-55.65-55.70-55.80-55FL/90LP-80.46-80.56-80.60-80.70-80.75-80.85-80.90-55-56N/DT/LM/LP55-66S/DT60-56DT60-66S/DT62-86F/DT65-66S/DT70-56DT70-66S/DT/F/LO72-86F/LP/DT80-66S/DT/F82-86F/LP/DT-82-93N/DT82-94N/DT88-93N/DT88-94N/DT55/88N/DT60-88N/DT65-88N/DT65-90N/DT55-4655-9060-4660-66F/LP60-76F60-90-60.93-60.94-65.46-65.56-65.66-65.93-65.94-70.76-70.76F/LP/P-70.88-70.90-72.93-72.94-80.76-80.88-85.90-88.93-88.94

**MECCANISMO RINFORZATO**  
N.B.: Quando si sostituisce un meccanismo non rinforzato con un meccanismo rinforzato, bisogna sostituire anche il disco PTO.

(segue FIAT RUOTE - NEW HOLLAND)

<p><b>Art. Kit 15929</b></p> 	 	<p>OEM Kit composto da: - Meccanismo 15505 - Disco PTO 15943</p>	
<p><b>Art. Kit 15938</b></p> 	    		<p>OEM Kit composto da: - Meccanismo 15505 - Disco PTO 15943 - Cuscinetti 15990 - 63896 - 63867</p>
<p><b>Art. 15505</b></p> 	<p>OEM 5162900-5150652 Meccanismo a 6 leve completo di disco centrale metalceramico a 6 pale senza il disco PTO. Piatto Ø 280 mm (11") Intercambiabile con meccanismo VALEO</p>	<p><b>Art. 15943</b> OEM 5145715 - 5154703 Disco PTO rigido in ferodo 280x165x3 mm 25x22EV - Z.10</p> 	<p><b>Art. 15520</b> OEM 5145715 - 5154703 Disco PTO rigido in ferodo 280x165x3 mm 25x22EV - Z.10</p> 
<p><b>Art. 15414</b></p> 	<p>OEM 5145711 Disco centrale metalceramico a 5 pale con molle parastrappi Ø 280 mm sinterizzato 40x35EV - Z.14</p>	<p><b>Art. 15528</b> OEM 5162901 Disco centrale metalceramico a 6 pale con molle parastrappi per meccanismo 15505 Ø 280 mm sinterizzato 40x35EV - Z.14</p> 	<p><b>Art. 15523</b> OEM 5156209 Disco centrale in ferodo con molle parastrappi 280x165x3,5 mm 40x35EV - Z.14</p> 
<p><b>Art. 15990</b></p> 	<p>OEM 5119290 5119875 - 5122028 - 87345759 Cuscinetto reggispinta cambio 90x50x22 mm</p>	<p><b>Art. 15280</b> OEM 5119290 - 5119875 - 5122028 - 87345759 Cuscinetto reggispinta cambio 90x50x22 mm</p> 	<p><b>Art. 62581</b> OEM 28043280 Cuscinetto volano 17x47x14 mm</p>  <p><b>Art. FAG 63867</b></p>
<p><b>Art. 15862</b></p> 	<p>OEM 5103178 Cuscinetto reggispinta</p>	<p><b>Art. 15863</b> OEM 599930 Cuscinetto reggispinta</p> 	<p><b>Art. 62951</b> OEM 24905360 - 84455696 Cuscinetto reggispinta PTO 70x110x20 mm</p>  <p><b>Art. FAG 63896</b></p>
<p><b>Art. 15751</b></p> 	<p>OEM 26794570 Cuscinetto PTO 65x100x11 mm <b>Per mod: 480S-500S-540S-550-600-640</b></p>	<p><b>new</b></p>	<p><b>Art. 16165</b> OEM 4954936 Collare <b>Per mod: 540-550-600-640</b></p> 
		<p><b>new</b></p>	<p><b>Art. 16167</b> OEM 4993817 Collare</p> 

# Frizioni e loro componenti

CLUTCHES - CLUTCH DISK - BEARING - COUPLING - LEVER - SET-REVISION

11

## segue FIAT RUOTE - NEW HOLLAND

550 - 600 -  
540 - 540DT -  
640 - 640DT -

Tipo VALEO

**NB: Frizione non intercambiabile con LUK. Controllare se i 6 fori di fissaggio sono da 10 mm.**

**Art. Kit 15661**

**Valeo**

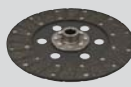

OEM K206  
Meccanismo a 6 leve **CON 6 FORI**  
**Ø 10 mm** completo di disco centrale metalceramico e disco PTO  
Piatto Ø 280 mm (11")

**IMPORTANTE!**  
**PER LA MODIFICA DA 3 A 6 LEVE ORDINARE I SEGUENTI ARTICOLI:**  
**15661 - 15280 - 15751 - 16165 - 16166 - 16187**

**Art. 15943**



OEM 5145715 - 5154703  
Disco PTO rigido in ferodo 280x165x3 mm 25x22EV - Z.10

**Art. 15520**



OEM 5145715 - 5154703  
Disco PTO rigido in ferodo 280x165x3 mm 25x22EV - Z.10

**Art. 15523**



OEM 5156209  
Disco centrale in ferodo con molle parastrappi 280x165x3,5 mm 40x35EV - Z.14

**Art. 15658**



OEM 5152710  
Disco PTO rigido in ferodo 280x165x3 mm 25x22EV - Z.10

**Art. 15414**



OEM 5011873 5160418  
Disco centrale metalceramico a 5 pale con molle parastrappi Ø 280 mm sinterizzato 40x35EV - Z.14

**Art. 15657**



OEM 5120435 - 5150653  
Disco centrale metalceramico a 5 pale, rigido Ø 280 mm sinterizzato 40x35EV - Z.14

**Art. 15751**



OEM 26794570  
Cuscinetto PTO 65x100x11 mm

**Art. 15990**



OEM 5119290 5119875 - 5122028 - 87345759  
Cuscinetto reggispinta cambio 90x50x22 mm

**Art. 15280**



OEM 5119290 - 5119875 - 5122028 - 87345759  
Cuscinetto reggispinta cambio 90x50x22 mm

new

**Art. 16165**



OEM 4954936  
Collare

new

**Art. 16166**



OEM 597149  
Collare

new

**Art. 16187**





















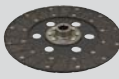

OEM 15971734  
Vite 10x1,25x95 - R10.9

# Frizioni e loro componenti

CLUTCHES - CLUTCH DISK - BEARING - COUPLING - LEVER - SET-REVISION

## segue FIAT RUOTE - NEW HOLLAND

55 - 60 S/DT 56 - 66 S 60 - 86 F/DT/V/S 70 - 86 V/DT FORD 4135	<b>Art. Kit 15934</b>  	OEM 87689658 Kit composto da: - Meccanismo 15869 - Disco PTO 15870 - Cuscinetti 63895 - 13990 - 63867
<b>Art. 15869</b>  OEM 5171494 Meccanismo frizione Piatto Ø 280 mm (11") con disco 35x31 mm - Z.18	<b>Art. 15870</b>  OEM 44909044 Disco PTO 19x22 mm - Z13	<b>Art. 15404</b>  OEM 5119875 Cuscinetto reggispinta 95x50x21,5 mm
<b>Art. 15990</b>  OEM 5119290 5119875 - 5122028 - 87345759 Cuscinetto reggispinta cambio 90x50x22 mm	<b>Art. 15280</b>  OEM 5119290 - 5119875 - 5122028 - 87345759 Cuscinetto reggispinta cambio 90x50x22 mm	<b>Art. 63363</b>  OEM 24905350 Cuscinetto PTO 100x65x18 mm  <b>Art. FAG 63895</b>
	<b>Art. 16168</b>  OEM 5124762 Collare	<b>Art. 62581</b>  OEM 28043280 Cuscinetto volano 17x47x14 mm  <b>Art. FAG 63867</b>
680 - 680DT - 780 - 780DT 570 - 570DT 580 - 580DT 670 - 670DT	<b>Art. Kit 15659</b>  	OEM 1930987 Meccanismo a 6 leve <b>CON 6 FORI</b> <b>Ø 10 mm</b> completo di disco centrale metalceramico a 5 pale fornito con disco PTO e cuscinetto reggispinta. Piatto Ø 280 mm (11")
<b>Tipo VALEO</b>  <b>NB: Frizione non intercambiabile con LUK.</b> <b>Controllare se i 6 fori di fissaggio sono da 10 mm.</b>	<b>Art. 15943</b>  OEM 5145715 - 5154703 Disco PTO rigido in ferodo 280x165x3 mm 25x22EV - Z.10	<b>Art. 15658</b>  OEM 5152710 Disco PTO rigido in ferodo 280x165x3 mm 25x22EV - Z.10
<b>Art. 15990</b>  OEM 5119290 - 5119875 - 5122028 - 87345759 Cuscinetto reggispinta cambio 90x50x22 mm	<b>Art. 15280</b>  OEM 5119290 - 5119875 - 5122028 - 87345759 Cuscinetto reggispinta cambio 90x50x22 mm	<b>Art. 15657</b>  OEM 5120435 - 5150653 Disco centrale metalceramico a 5 pale, rigido Ø 280 mm sinterizzato 40x35EV - Z.14
		<b>Art. 15660</b>  OEM 5177194 Cuscinetto reggispinta  <b>Art. 16187</b>  OEM 15971734 Vite 10x1,25x95 - R10.9
(segue FIAT RUOTE - NEW HOLLAND)		































# Frizioni e loro componenti

CLUTCHES - CLUTCH DISK - BEARING - COUPLING - LEVER - SET-REVISION

11

## segue FIAT RUOTE - NEW HOLLAND











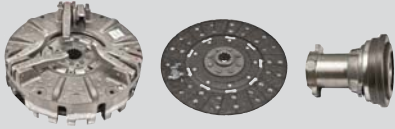











650 - 650 DT - 750 - 750DT	<b>Art. 15383</b> OEM 44015415 - 5160409 Disco centrale rigido in ferodo 310x175x3,5 mm 45x40EV - Z.16 	<b>Art. 15277</b> OEM 5107374 5160414 - 44016542 Disco PTO rigido in ferodo 310x175x3,5 mm 32x28EV - Z.11 	<b>Art. 15969</b> OEM 5102263 - 5160410 Disco PTO rigido in ferodo 280x165x3,5 mm 28x24EV - Z.10 	
		<b>Art. 15802</b> OEM 9004189 Disco frizione centrale rigido 310x190x3,5 35x30EV H35-Z.12 	<b>Art. 15799</b> OEM 9023573 Cuscinetto reggispinta solo per 750 - 750 DT 65x102x26 mm 	
880 - 880DT Tipo VALEO	<b>Art. 15866</b> OEM 5177197 Cuscinetto reggispinta completo doppio 	<b>Art. 15556</b> OEM 5104790 - 9929202 Disco centrale metalceramico rigido a 6 pale Ø 280 mm sinterizzato 45x40EV - Z.16 	<b>Art. 15372</b> OEM 5160420 - 9929199 Disco PTO in ferodo 280x165x3,8 mm 28x24EV - Z.10 	
	<b>Art. 15863</b> OEM 599930 Cuscinetto reggispinta 			
880.4 - 880.4 DT	<b>Art. Kit 15558</b>   	OEM 5122376 Meccanismo a 6 leve completo di disco centrale sinterizzato, fornito senza il disco PTO Piatto Ø 310 mm (12")		
		<b>Art. 15559</b> OEM 5122377 Disco centrale metalceramico rigido a 6 pale Ø 310 mm sinterizzato 45x40EV - Z.16 	<b>Art. 15581</b> OEM 5104880 - 5160417 Disco PTO rigido in ferodo 310x190x4 mm 28x24EV - Z.10 	
850 - 880 - 880.4	<b>Art. Kit 16077</b>      	OEM 5160430 - 5114526 - 88203010  Kit composto da: - Meccanismo 15555 - Disco PTO 15969 - Cuscinetti 15990 - 63896 - 63867		
	<b>Art. 15555</b> OEM 5114526-5160430 Meccanismo a 6 leve completo di disco centrale sinterizzato. Fornito senza il disco PTO Piatto Ø 280 mm (11") 	<b>Art. 15969</b> OEM 5102263 - 5160410 Disco PTO rigido in ferodo 280x165x3,5 mm 28x24EV - Z.10 	<b>Art. 15557</b> OEM 5102263 - 5160410 Disco PTO rigido in ferodo 280x165x3,5 mm 28x24EV - Z.10 	
	<b>Art. 15556</b> OEM5102262 Disco centrale metalceramico rigido a 6 pale Ø 280 mm sinterizzato 45x40EV - Z.16 	<b>Art. 15990</b> OEM 5119290 5119875 - 5122028 - 87345759 Cuscinetto reggispinta cambio 90x50x22 mm 	<b>Art. 15280</b> OEM 5119290 - 5119875 - 5122028 - 87345759 Cuscinetto reggispinta cambio 90x50x22 mm 	
		<b>Art. 62951</b> OEM 24905360 - 84455696 Cuscinetto reggispinta PTO 70x110x20 mm 	<b>Art. 62581</b> OEM 28043280 Cuscinetto volano 17x47x14 mm 	
		<b>Art. FAG 63896</b>	<b>Art. FAG 63867</b>	

(segue FIAT RUOTE -  
NEW HOLLAND)

# Frizioni e loro componenti

CLUTCHES - CLUTCH DISK - BEARING - COUPLING - LEVER - SET-REVISION

## segue FIAT RUOTE - NEW HOLLAND



































850 - 850 DT - 1000 SUPER - 1000 DT SUPER	<b>Art. Kit 15662</b>  	OEM 1930990 - Meccanismo a 6 leve completo di disco centrale metalceramico molloggiato fornito con il disco PTO e cuscinetto reggispinta - Piatto Ø 310 mm (12")		
	<b>Art. Kit 16045</b>  			
	<b>Art. 15277</b> OEM 5107374 5160414 - 44016542 Disco PTO rigido in ferodo 310x175x3,5 mm 32x28EV - Z.11 	<b>Art. 15416</b> OEM 44015757 Disco centrale metalceramico con molle Ø 310 mm sinterizzato 45x40EV - Z.16 	<b>Art. 15864</b> OEM 44011614 Cuscinetto reggispinta 55x92x22 mm (tolleranza 8mm) 	
			<b>new</b> <b>Art. 16186</b> OEM 15971831 Vite 10x1,25x100 - R10.9 	
570N/DT 670N/DT 1000 NORMALE - 1000 DT NORMALE	<b>Art. Kit 16072</b>  	OEM 5164573 - 88203026 Kit composto da: - Meccanismo 15561 - Disco PTO 15563 - Cuscinetti 15755 - 15756 - 63869		
	<b>Art. 15561</b> OEM 5164573-5160435 Meccanismo a 6 leve completo di disco centrale metalceramico a 6 pale senza il disco di PTO Piatto Ø 330 mm 	<b>Art. 15562</b> OEM 4998654 5164568 Disco centrale metalceramico con molle a 6 pale Ø 330 mm sinterizzato 45x40EV - Z.16 	<b>Art. 15563</b> OEM 5164569 Disco PTO rigido in ferodo 330x200x3,5 mm - Z.11 	
	<b>Art. 15755</b> OEM 5120853 Cuscinetto reggispinta cambio 96,5x65x23,5 mm 	<b>Art. 15756</b> OEM 44016827 Cuscinetto reggispinta PTO 106x139,5x25 mm 	<b>Art. 62583</b> OEM 28042740 Cuscinetto volano 20x47x14 mm 	<b>Art. FAG 63869</b>
880.5 - 880.5 DT - 980 - 90.90 - 100.90 - 110.90  Dal febbraio 1980 in avanti  Originale VALEO  (segue FIAT RUOTE - NEW HOLLAND)	<b>Art. Kit 15650</b>  	OEM 1930988 - Meccanismo a 6 leve completo di disco centrale metalceramico rigido - Piatto Ø 310 mm (12")		
	<b>Art. 15261</b> OEM 5122560 - 5144011 Disco centrale metalceramico rigido a 6 pale Ø 310 sinterizz. 45x40EV - Z.16 	<b>Art. 15651</b> OEM 5114522 - 5160434 Disco PTO rigido in ferodo 310x175x3,5 mm - 28x24EV - Z.10 	<b>Art. 15114</b> OEM 5114522 - 5160434 Disco PTO rigido in ferodo 310x175x3,5 mm 28x24EV - Z.10 	
	<b>new</b> <b>Art. 16186</b> OEM 15971831 Vite 10x1,25x100 - R10.9 	<b>Art. 15864</b> OEM 44011614 Cuscinetto reggispinta Frizione con diaframma 55x92x22 mm (tolleranza 8mm) 	<b>Art. 15866</b> OEM 5177197 Cuscinetto reggispinta completo doppio per frizione a 6 leve 	

# Frizioni e loro componenti

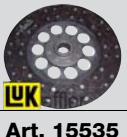
CLUTCHES - CLUTCH DISK - BEARING - COUPLING - LEVER - SET-REVISION

11

## segue FIAT RUOTE - NEW HOLLAND















































<p>90.90N/DT/F/S - 90.95 - 90/S - 100.90N/DT/F/S - 110.90N/DT/S - 880.5N/DT - 880 II° tipo - 980</p> <p><b>MECCANISMO RINFORZATO</b></p> <p>N.B.: Quando si sostituisce un meccanismo non rinforzato con un meccanismo rinforzato, bisogna sostituire anche il disco PTO.</p>	<p><b>Art. Kit 15932</b></p>    <p>OEM</p> <p>Kit composto da: - Meccanismo 15530 - Disco PTO 15966</p>		
	<p><b>Art. Kit 15978</b></p>       <p>OEM</p> <p>Kit composto da: - Meccanismo 15530 - Disco PTO 15966 - Cuscinetti 15990 - 63897 - 63869</p>		
	<p><b>Art. 15530</b></p>  <p>OEM 5163936 Meccanismo a 6 leve completo di disco centrale metalceramico a 7 pale. Fornito senza il disco PTO. Piatto Ø 310 mm (12") Intercambiabile con meccanismo VALEO</p>	<p><b>Art. 15966</b></p>  <p>OEM 5144741 - 5154514 Disco PTO rigido in ferodo, per meccanismo 15530 310x190x3 mm 28x24EV - Z.10</p>	<p><b>Art. 15532</b></p>  <p>OEM 5144741 - 5154514 Disco PTO rigido in ferodo, per meccanismo 15530 310x190x3 mm 28x24EV - Z.10</p>
	<p><b>Art. 15531</b></p>  <p>OEM 5163937 Disco centrale metalceramico rigido a 7 pale per meccanismo 15530 Ø 310 sinterizzato (12") 45x40EV - Z.16</p>	<p><b>Art. 15990</b></p>  <p>OEM 5119290 - 5119875 - 5122028 - 87345759 Cuscinetto reggispinta cambio 90x50x22 mm</p>	<p><b>Art. 15280</b></p>  <p>OEM 5119290 - 5119875 - 5122028 - 87345759 Cuscinetto reggispinta cambio 90x50x22 mm</p> <p><b>Art. 15800</b></p> <p>Nuova Versione OEM 5197980</p>
		<p><b>Art. 62952</b></p>  <p>OEM 5112084 - 47127081 Cuscinetto reggispinta PTO 75x115x20 mm</p> <p><b>Art. FAG 63897</b></p>	<p><b>Art. 62583</b></p>  <p>OEM 28042740 Cuscinetto volano 20x47x14 mm</p> <p><b>Art. FAG 63869</b></p>
<p>1180 - 1180 DT</p> <p><b>Originale VALEO</b></p>	<p><b>Art. 15665</b></p>  <p>OEM1930989 Meccanismo a 6 leve completo di disco metalceramico rigido, fornito con disco PTO e cuscinetto reggispinta. Piatto Ø 310 mm (12")</p>	<p><b>Art. 15374</b></p>  <p>OEM 5116492 Disco centrale metalceramico rigido a 8 pale Ø 310 mm sinterizzato 50x45EV - Z.18</p>	<p><b>Art. 15277</b></p>  <p>OEM 5160418 Disco PTO rigido in ferodo 310x175x3,5 mm 32x28EV Z.11</p>
	<p><b>Art. 16186</b></p>  <p>OEM 15971831 Vite 10x1,25x100 - R10.9</p> <p><b>new</b></p>	<p><b>Art. 15969</b></p>  <p>OEM 5102263 - 5160410 Disco PTO rigido in ferodo 280x165x3,5 mm 28x24EV - Z.10</p> <p><b>LUK</b></p>	
<p>1180 - 1180 DT - 115.90 N/DT</p> <p><b>new</b></p>	<p><b>Art. Kit 16143</b></p>       <p>OEM 73328284 Kit composto da: - Meccanismo 15534 - Disco PTO 15970 - Cuscinetti 15755 - 15756 - 63869</p>		
	<p><b>Art. 15534</b></p>  <p>OEM 5144661-5154661 Meccanismo a 6 leve completo di disco centrale metalceramico, senza il disco di PTO Piatto Ø 310 mm (12")</p>	<p><b>Art. 15970</b></p>  <p>OEM 5154551 Disco PTO rigido in ferodo 310x190x4 mm 32x28EV - Z.11</p>	<p><b>Art. 15536</b></p>  <p>OEM 5154551 Disco PTO rigido in ferodo 310x190x4 mm 32x28EV - Z.11</p>
	<p><b>Art. 15535</b></p>  <p>OEM 5143411 Disco centrale metalceramico rigido a 8 pale Ø 310 mm sinterizzato 50x45EV - Z.18</p>	<p><b>Art. 15756</b></p>  <p>OEM 44016827 Cuscinetto reggispinta PTO 106x139,5x25 mm</p>	
	<p><b>Art. 15755</b></p>  <p>OEM 5120853 Cuscinetto reggispinta cambio 96,5x65x23,5 mm</p>	<p><b>Art. 62583</b></p>  <p>OEM 28042740 Cuscinetto volano 20x47x14 mm</p> <p><b>Art. FAG 63869</b></p>	

(segue FIAT RUOTE - NEW HOLLAND)

# Frizioni e loro componenti

CLUTCHES - CLUTCH DISK - BEARING - COUPLING - LEVER - SET-REVISION

## segue FIAT RUOTE - NEW HOLLAND

<p>TD4020F - TD4030F - TD4040F TD5010 - TD5020 - TD5030 TD5.75 - TD5.80 - TD5.85 - TD5.90</p>	<p><b>Art. Kit 16033</b>      </p>	<p>OEM 5097927 - 84177326 - 84328337 Kit composto da: - Meccanismo 15874 - Disco PTO 15943 - Cuscinetti 15990 - 63896 - 63867</p>	
	<p><b>Art. 15874</b> OEM 84177326   Meccanismo frizione a 6 leve con disco interno a 6 pale Z.14 Piatto Ø 280 mm (11")</p>	<p><b>Art. 15943</b> OEM 5145715 - 5154703 Disco PTO rigido in ferodo 280x165x3 mm 25x22EV - Z.10  </p>	<p><b>Art. 15520</b> OEM 5145715 - 5154703 Disco PTO rigido in ferodo 280x165x3 mm 25x22EV - Z.10 </p>
		<p><b>Art. 15990</b> OEM 5119290 - 5119875 - 5122028 - 87345759   Cuscinetto reggisplinta cambio 90x50x22 mm</p>	<p><b>Art. 15280</b> OEM 5119290 - 5119875 - 5122028 - 87345759  Cuscinetto reggisplinta cambio 90x50x22 mm</p>
		<p><b>Art. 62951</b> OEM 24905360 - 84455696  Cuscinetto reggisplinta PTO 70x110x20 mm <b>Art. FAG 63896</b></p>	<p><b>Art. 62581</b> OEM 28043280  Cuscinetto volano 17x47x14 mm <b>Art. FAG 63867</b></p>
<p>TD 5040-5050 TD 60/D-70/D-80/D-90/D-95/D/PLUS</p>	<p><b>Art. 15876</b> OEM 5092803   Meccanismo frizione a 6 leve con disco interno a 6 pale Z.16 Piatto Ø 310 mm (12")</p>	<p><b>Art. 15877</b> OEM 5089337   Disco frizione Ø 310 mm 22x25 mm - Z.10</p>	<p><b>Art. 62951</b> OEM 24905360 - 84455696  Cuscinetto reggisplinta PTO 70x110x20 mm <b>Art. FAG 63896</b></p>
	<p><b>Art. 15990</b> OEM 5119290 - 5119875 - 5122028 - 87345759   Cuscinetto reggisplinta cambio 90x50x22 mm</p>	<p><b>Art. 15280</b> OEM 5119290 - 5119875 - 5122028 - 87345759  Cuscinetto reggisplinta cambio 90x50x22 mm</p>	<p><b>Art. 62581</b> OEM 28043280  Cuscinetto volano 17x47x14 mm <b>Art. FAG 63867</b></p>
<p>1280N/DT - 1380N/DT - 1580N/DT - 1880N/DT - 1180 MONDISCO 115.90N/DT 130.90N/DT 140.90N/DT</p>	<p><b>Art. Kit 15926</b>    OEM Kit composto da: - Meccanismo 15283 - Disco 15967</p>		
	<p><b>Art. 15285</b> OEM 5124399 - 5123062   Meccanismo di movimento Piatto Ø 350 mm</p>	<p><b>Art. 15967</b> OEM 5118453   Disco presa di movimento con 8 pale 69x77x4 mm metalceramica e con molle parastrappi Ø 352 mm sinterizzato 45x50 mm - Z.18</p>	<p><b>Art. 15284</b> OEM 5118453  Disco presa di movimento con 8 pale 69x77x4 mm metalceramica e con molle parastrappi Ø 352 sinterizzato 45x50 mm - Z.18</p>
	<p><b>Art. 15275</b> OEM 5141934   Frizione multidisco PTO 5" 1/2 P.T.O.</p>	<p><b>new</b>  <b>Art. 84025</b> Pompa idraulica per 15275 spessore 30mm <b>Art. 84026</b> Pompa idraulica per 15275 spessore 40,5mm</p>	
	<p><b>Art. 15801</b> OEM 5121414   Manicotto con cuscinetto VALEO</p>	<p><b>Art. 15288</b> OEM 44016083   Manicotto con cuscinetto reggisplinta (solo per modelli 1300 - 1300DT)</p>	<p><b>Art. 15755</b> OEM 5120853  Cuscinetto reggisplinta 96,5x65x23,5 mm</p>
<p>1300 - 1300 DT  (segue FIAT RUOTE - NEW HOLLAND)</p>	<p><b>Art. 15285</b> OEM 5124399 - 5123062   Meccanismo di movimento Piatto Ø 350 mm</p>	<p><b>Art. 15567</b> OEM 5130781  Disco metalceramico a 8 pale con molle parastrappi Ø 350 mm sinterizzato 45x50 - Z.18</p>	<p><b>Art. 15288</b> OEM 44016083   Manicotto con cuscinetto reggisplinta (solo per modelli 1300 - 1300DT)</p>































# Frizioni e loro componenti

CLUTCHES - CLUTCH DISK - BEARING - COUPLING - LEVER - SET-REVISION

11

## segue FIAT RUOTE - NEW HOLLAND















































160.90 - 160.90 DT TURBO - 180.90 - 180.90 DT TURBO - (CENTRAGGIO ESTERNO) 1580 - 1880	<b>Art. Kit 15939</b>   	OEM 5140361 Kit frizione con meccanismo a 6 leve e disco Ø 310 mm	
	<b>Art. 15537</b>  OEM 5123061-5128011 Disco metalceramico a 6 pale con molle parastrappi Ø 310 mm sinterizzato 50x45EV - Z.18	<b>Art. 15275</b>  OEM 5141934 Frizione multidisco PTO 5" 1/2 P.T.O.	
<b>new</b>  OEM 5143858 Manicotto reggispinta con cuscinetto 	<b>new</b>  <b>Art. 84025</b> Pompa idraulica per 15275 spessore 30mm <b>Art. 84026</b> Pompa idraulica per 15275 spessore 40,5mm	<b>Art. 15755</b>  OEM 5120853 Cuscinetto reggispinta cambio 96,5x65x23,5 mm	
		<b>Art. 15564</b>  OEM5177618 - 5154418 - 133021410 Meccanismo con molle a diaframma Piatto Ø 330 mm	<b>Art. 15565</b>  OEM 5165650-333007211 Disco metalceramico a 5 pale con molle parastrappi. Ø 327 mm sinterizzato Z.18
WINNER F100DT - F110DT - F115 - F120DT TM 110 - 115 - 120 - 125 - 130 - 140 FORD 8160 - 8260 - 8360 - M100 - M115 - M135	<b>Art. Kit 15927</b>   	OEM Kit composto da: - Meccanismo 15566 - Disco 15968	
	<b>Art. 15566</b>  OEM 5150079-5177620 Meccanismo con molle a diaframma Piatto Ø 350 mm	<b>Art. 15968</b>  OEM 5165648 Disco metalceramico a 6 pale con molle parastrappi Ø 350 mm sinterizzato Z.18	<b>Art. 15753</b>  OEM 9967339 - 5149611 500085130 Cuscinetto con manicotto 65x61x104 mm
5635 - 4835 - 4635 - 6635 - 7635 L60 - L65 - L75 - L85 L95 TL65A	<b>Art. Kit 16069</b>      	OEM 87689673 Kit composto da: - Meccanismo 15782 - Disco PTO 15783 - Cuscinetti 15990 - 63897 - 63867	
	<b>Art. 15782</b>  OEM 5167923 Meccanismo a 6 leve completo di disco centrale in ferodo senza il disco PTO Piatto Ø 280 mm	<b>Art. 15783</b>  OEM 5167925 Disco PTO rigido in ferodo Ø 280 mm 22x25 Z10	<b>Art. 15990</b>  OEM 5119290 5119875 - 5122028 - 87345759 Cuscinetto reggispinta cambio 90x50x22 mm
<b>Art. 62581</b>  OEM 500311249 Cuscinetto volano 17x47x14 mm <b>Art. FAG 63867</b>	<b>Art. 62952</b>  OEM 47127081 Cuscinetto reggispinta PTO 75x115x20 mm <b>Art. FAG 63897</b>	<b>Art. 15280</b>  OEM 5119290 - 5119875 - 5122028 - 87345759 Cuscinetto reggispinta cambio 90x50x22 mm	

(segue FIAT RUOTE - NEW HOLLAND)

# Frizioni e loro componenti

CLUTCHES - CLUTCH DISK - BEARING - COUPLING - LEVER - SET-REVISION

## segue FIAT RUOTE - NEW HOLLAND

4835 L65 TL70	<b>Art. Kit 16034</b>  	OEM 87689674		
	<b>Art. 15784</b>  	OEM 5167933 Meccanismo a 6 leve completo di disco centrale in ferodo senza il disco PTO Piatto Ø 310 mm	<b>Art. 15785</b>  	OEM 5167937 Disco PTO rigido in ferodo senza molleggio Ø 310 mm - 22x25 Z10
	<b>Art. 15990</b>  	OEM 5119290 - 5119875 - 5122028 - 87345759 Cuscinetto reggispinta cambio 90x50x22 mm	<b>Art. 15280</b>  	OEM 5119290 - 5119875 - 5122028 - 87345759 Cuscinetto reggispinta cambio 90x50x22 mm
6635 - 5635 - 7635 T4.105 - T4.75 - T4.85 - T4.95 T5030 - T5040 TD60D PLUS - TD70D PLUS - TD80D PLUS - TD90D PLUS - TD95D PLUS TL100 - TL95 - TL80 - TL75 - TL90 - TL85 TL70A - TL80A - TL90A TL75E - TL85E - TL95E	<b>Art. Kit 16056</b>  	OEM 9973687 Kit composto da: - Meccanismo 15786 - Disco PTO 15785 - Cuscinetti 15990 - 63897 - 63867		
	<b>Art. Kit 15981</b>  	OEM Kit composto da: - Meccanismo 15786 - Disco PTO 15792 - Cuscinetti 15990 - 63896 - 63867		
	<b>Art. 15786</b>  	OEM 5189875-47126706-87716719 Meccanismo a 6 leve completo di disco centrale cerametallico 6 pale senza il disco PTO Piatto Ø 310 mm	<b>Art. 15792</b>  	<b>Art. 15785</b>  
	<b>Art. 62951</b>  	OEM 24905360 - 84455696 Cuscinetto reggispinta PTO 70x110x20 mm	<b>Art. 15990</b>  	<b>Art. 15280</b>  
			<b>Art. 62952</b>  	<b>Art. 62581</b>  
			<b>Art. FAG 63896</b>  	<b>Art. 15280</b>  
T5030 - T5040 - T5050 - T5060 - TL100 - TL100A - TL70 - TL70A - TL80 - TL80A - TL90 - TL90A - L60 - L65 - L75 - L85 - L85 - L95 - 4635 - 4835 - 5635 - 6635 - 7635 FORD L75 - L85 - L95 - T5030 - T5040 - T5060	<b>Art. Kit 16075</b>  	OEM Kit composto da: - Meccanismo 15787 - Disco avanzamento 15788		
	<b>Art. 15787</b>  	OEM 5167939 5189823 87575337 Meccanismo Piatto Ø 310 mm	<b>Art. 15788</b>  	<b>Art. 16009</b>  
	<b>Art. 16076</b>  	OEM 47133433 Damper Ø 136 mm 22x25 mm - Z10	<b>Art. 16018</b>  	OEM 5181872 Parastrappo Ø 116 mm 22x15 mm - Z10

















































(segue FIAT RUOTE - NEW HOLLAND)

# Frizioni e loro componenti

CLUTCHES - CLUTCH DISK - BEARING - COUPLING - LEVER - SET-REVISION

11

## segue FIAT RUOTE - NEW HOLLAND































<p>SERIE TN (3 cil.) TN 60A - 60VA TN55 - 55V TN65 - 65V TN70 - TN75 - 75N/V</p>	<p><b>Art. Kit 15977</b></p>      	<p>OEM Kit composto da: - Meccanismo 15789 - Disco PTO 15792 - Cuscinetti 15990 - 63897 - 63867</p>	
	<p><b>Art. 15789</b></p>   <p>OEM 5186552 5196816 Meccanismo a 6 leve completo di disco centrale Piatto Ø 280 mm</p>	<p><b>Art. 15792</b></p>   <p>OEM 5176450 - 47134874 - 5196819 Disco PTO rigido in cerametallico 4 pale Ø 280 mm - 22x25 Z10</p>	
		<p><b>Art. 15990</b></p>   <p>OEM 5119290 - 5119875 - 5122028 - 87345759 Cuscinetto reggispinta cambio 90x50x22 mm</p>	<p><b>Art. 15280</b></p>  <p>OEM 5119290 - 5119875 - 5122028 - 87345759 Cuscinetto reggispinta cambio 90x50x22 mm</p>
		<p><b>Art. 62952</b></p>  <p>OEM 5112084 - 47127081 Cuscinetto reggispinta PTO 75x115x20 mm</p> <p><b>Art. FAG 63897</b></p>	<p><b>Art. 62581</b></p>  <p>OEM 28043280 Cuscinetto volano 17x47x14 mm</p> <p><b>Art. FAG 63867</b></p>
<p>SERIE TN (3 cil.) TN55/V - TN60A/VA - TN65/N/V - TN70/A/NA/VA - TN75/A/N/NA/VA TN95NA/VA</p>	<p><b>Art. Kit 16035</b></p>      	<p>OEM 73328271 Kit composto da: - Meccanismo 15793 - Disco PTO 15792 - Cuscinetti 15990 - 63897 - 63867</p>	
	<p><b>Art. 15793</b></p>   <p>OEM 5196818-47134898 Meccanismo a 6 leve completo di disco centrale cerametallico 5 pale Piatto Ø 280 mm</p>	<p><b>Art. 15792</b></p>   <p>OEM 5176450 - 47134874 - 5196819 Disco PTO rigido in cerametallico 4 pale Ø 280 mm - 22x25 Z10</p>	
		<p><b>Art. 15990</b></p>   <p>OEM 5119290 - 5119875 - 5122028 - 87345759 Cuscinetto reggispinta cambio 90x50x22 mm</p>	<p><b>Art. 15280</b></p>  <p>OEM 5119290 - 5119875 - 5122028 - 87345759 Cuscinetto reggispinta cambio 90x50x22 mm</p>
		<p><b>Art. 62952</b></p>  <p>OEM 5112084 - 47127081 Cuscinetto reggispinta PTO 75x115x20 mm</p> <p><b>Art. FAG 63897</b></p>	<p><b>Art. 62581</b></p>  <p>OEM 28043280 Cuscinetto volano 17x47x14 mm</p> <p><b>Art. FAG 63867</b></p>
<p>SERIE TN (4 cil.) TN 65 F TN75 TN90F TN85A/DA/FA/SA TN95A/DA/FA/NA/VA T4030 T4040 T4050</p>	<p><b>Art. Kit 16036</b></p>      	<p>OEM 87689675 Kit composto da: - Meccanismo 15796 - Disco PTO 15792 - Cuscinetti 15990 - 63897 - 63867</p>	
	<p><b>Art. Kit 15930</b></p>   	<p>OEM Kit composto da: - Meccanismo 15796 - Disco PTO 15792</p>	
	<p><b>Art. 15796</b></p>   <p>OEM 87732504 5181421 - 5196813 - 47134895 - 87732503 - 87732506 Meccanismo a 6 leve completo di disco centrale cerametallico 5 pale Piatto Ø 280 mm 35x39,8 mm - Z.14</p>	<p><b>Art. 15990</b></p>   <p>OEM 5119290 - 5119875 - 5122028 - 87345759 Cuscinetto reggispinta cambio 90x50x22 mm</p>	<p><b>Art. 15280</b></p>  <p>OEM 5119290 - 5119875 - 5122028 - 87345759 Cuscinetto reggispinta cambio 90x50x22 mm</p>
	<p><b>Art. 15792</b></p>   <p>OEM 5176450 - 47134874 - 5196819 Disco PTO rigido in cerametallico 4 pale Ø 280 mm - 22x25 Z10</p>	<p><b>Art. 62952</b></p>  <p>OEM 5112084 - 47127081 Cuscinetto reggispinta PTO 75x115x20 mm</p> <p><b>Art. FAG 63897</b></p>	<p><b>Art. 62581</b></p>  <p>OEM 28043280 Cuscinetto volano 17x47x14 mm</p> <p><b>Art. FAG 63867</b></p>

(segue FIAT RUOTE - NEW HOLLAND)



# Frizioni e loro componenti

CLUTCHES - CLUTCH DISK - BEARING - COUPLING - LEVER - SET-REVISION

## segue FIAT RUOTE - NEW HOLLAND

SERIE TN (4 cil.) con POWERSHIFT TN55D/S/V - TN60A/DA/SA/VA TN65D/F/N/S/V - TN70A/D/DA/F/S/ SA/VA - TN75A/D/DA/FA/N/ NA/S/SA/VA - TN80F - TN90F - TN95F/FA/NA/VA	<b>Art. Kit 16073</b>     	OEM 47134873 - 47134884 - 87732490 - 5196770 - 47134886 Kit composto da: - Meccanismo 15797 - Disco PTO 15792 - Cuscinetti 63897 - 63867	
	<b>Art. 15797</b>  	<b>Art. 15792</b>  	OEM 5186548 - 5186550 - 47134884 - 5196770 - 47134873 - 87732485 - 47134886 Meccanismo Piatto Ø 280 mm
			<b>Art. 62581</b>  
		<b>Art. 62952</b>  	
T4.75, T4.85 T5.75, T5.85 TD4.80F, TD4.90F TD4030F, TD4040F TD85F	<b>Art. Kit 16212</b>   	OEM 84342957 Kit composto da: - Meccanismo - Disco	
	<b>Art. 62952</b>  	<b>Art. 15280</b>  	
		<b>Art. 62580</b>  	
T4.55, T4.65, T4.75	<b>Art. Kit 16217</b>   	OEM 84233502 Kit composto da: - Meccanismo - Disco	
	<b>Art. 15280</b>  	<b>Art. 62952</b>  	
		<b>Art. 62580</b>  	

## FIAT CINGOLI

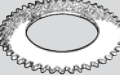









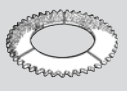

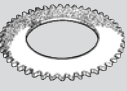
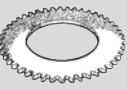

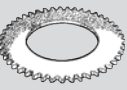
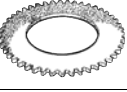
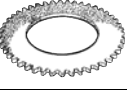
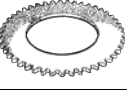

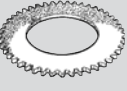

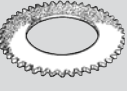



25C - CL - CF - CS	<b>Art. 15206</b> 	OEM 544583 Anello frizione di sterzo - dentatura esterna 219,2x152x6 mm 71 denti	
70 C - CL - 80 C - CA - 90 C - 100 C - 120 C	<b>Art. 15171</b> 	OEM 76033269 Anello frizione di sterzo - dentatura esterna 309x214x5,4-101 denti	<b>Art. 15764</b> 
311C - 332C - 351C - 352C (segue FIAT CINGOLI)	<b>Art. 15417</b> 	OEM 568911 Anello frizione di sterzo - dentatura esterna 219,2x152x4,7 mm 71 denti	



# Frizioni e loro componenti

CLUTCHES - CLUTCH DISK - BEARING - COUPLING - LEVER - SET-REVISION

## segue FIAT CINGOLI











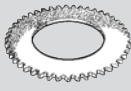
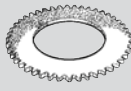

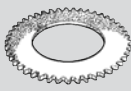

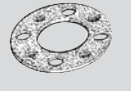
355C - 400C - 411C - CL - 451C - 455C - CDAL - C SUPER - 505C - C SUPER	<b>Art. 15173</b>  OEM588433 Anello per frizione centrale - dentatura esterna 277x156x10 (1/3 T) 45 denti	<b>Art. 15388</b>  OEM571707 Anello per frizione cambio 88x48x4,5 mm 8 fori	<b>Art. 15176</b>  OEM 5109934 - 5109937 - 5161615 Anello per frizione di sterzo - in tessuto - dentatura esterna 239x180x4,8 - 28 denti
	<b>Art. 15174</b>  OEM 5109937 5109934-5161615 Anello per frizione di sterzo - in conglomerato - dentatura esterna 239x180x4,8 - 28 denti	<b>Art. 15389</b>  OEM 5109934 - 5109937 - 5161615 Anello per frizione di sterzo - dentatura interna 229x171x2 - 21 denti	<b>Art. 15668</b>  OEM 5109934 - 5109937 - 5161615 Anello per frizione di sterzo - sinterizzato - dentatura esterna 239x180x4 - 28 denti
465 VIGNETO - 465 C FRUTTETO	<b>Art. 15317</b>  OEM 5122253-5127787 Anello per frizione centrale - dentatura esterna - 45 denti 273x166x7 mm	<b>Art. 15176</b>  OEM 5109937 5109934-5161615 Anello per frizione di sterzo - in tessuto - dentatura esterna 239x180x4,8 - 28 denti	<b>Art. 15668</b>  OEM 5109934 - 5109937 - 5161615 Anello per frizione di sterzo - sinterizzato - dentatura esterna 239x180x4 - 28 denti
	<b>Art. 15174</b>  OEM 5109937 Anello per frizione di sterzo - in conglomerato - dentatura esterna 239x180x4,8 - 28 denti	<b>Art. 15389</b>  OEM 566519 Anello per frizione di sterzo - dentatura interna 229x171x2 - 21 denti	
555C - 565C - 605C - 605C SUPER	<b>Art. 15177</b>  OEM 596511 Anello per frizione centrale - dentatura esterna 277x166x7 mm 45 denti	<b>Art. 15388</b>  OEM 571707 Anello per frizione cambio 88x48x4,5 mm 8 fori	<b>Art. 15176</b>  OEM 5109934 - 5109937 - 5161615 Anello per frizione di sterzo - in tessuto - dentatura esterna 239x180x4,8 mm 28 denti
	<b>Art. 15174</b>  OEM 5109934 - 5109937 - 5161615 Anello per frizione di sterzo - in conglomerato - dentatura esterna 239x180x4,8 mm 28 denti	<b>Art. 15389</b>  OEM 566519 Anello per frizione di sterzo - dentatura interna 229x171x2 mm 21 denti	<b>Art. 15668</b>  OEM 5109934 - 5109937 - 5161615 Anello per frizione di sterzo - sinterizzato - dentatura esterna 239x180x4 mm 28 denti
565 C - 665 C - 765 C	<b>Art. 15317</b>  OEM5122253-5127787 Anello per frizione centrale - dentatura esterna 273x166x7 mm 45 denti	<b>Art. 15582</b>  OEM 5112063 - 5169148 Anello per frizione cambio 116x73x4,5 mm 4 fori	<b>Art. 15583</b>  OEM 5121348 Anello per disco PTO 280x165x3,5 mm 24 fori
	<b>Art. 15176</b>  OEM 5109934 5109937 - 5161615 Anello per frizione di sterzo - in tessuto - dentatura esterna 239x180x4,8 mm 28 denti	<b>Art. 15174</b>  OEM 5109934 5109937 - 5161615 Anello per frizione di sterzo - in conglomerato - dentatura esterna 239x180x4,8 mm 28 denti	<b>Art. 15389</b>  OEM 566519 Anello per frizione di sterzo - dentatura interna 229x171x2 mm 21 denti
			<b>Art. 15668</b>  OEM 5109934 - 5109937 - 5161615 Anello per frizione di sterzo - sinterizzato - dentatura esterna 239x180x4 mm 28 denti
655C - 805C	<b>Art. 15178</b>  OEM 568400 - 5104903 - 5161597 Anello per frizione di sterzo - dentatura esterna 271x201x5 mm 89 denti	<b>Art. 15766</b>  OEM 547395 Controdisco 260x190x2,5 mm 65 denti	
855C - 955C - 85.55 - 95.55 100.55  (segue FIAT CINGOLI)	<b>Art. 15269</b>  OEM 5107223 - 5161598 - 5180285 Anello per frizione di sterzo - dentatura esterna 283,3x216x5 mm 93 denti	<b>Art. 15765</b>  OEM 5107259 Controdisco 271x205x2,5 mm 70 denti	



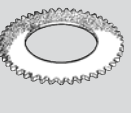









# Frizioni e loro componenti

CLUTCHES - CLUTCH DISK - BEARING - COUPLING - LEVER - SET-REVISION

## segue FIAT CINGOLI

55.65 FRUTTETO - 55.65 VIGNETO - 55.65 MONTAGNA - 60.65 VIGNETO - 60.65 FRUTTETO - 60.65 MONTAGNA - 70.65 - 70.65 MONTAGNA - 80.65	<b>Art. 15317</b>  OEM 5122253 5127787 - 5163798 Anello per frizione centrale - dentatura esterna 273x166x7 mm - 45 denti	<b>Art. 15176</b>  OEM 5109937 5109934-5161615 Anello per frizione di sterzo - in tessuto - dentatura esterna 239x180x4,8 mm - 28 denti	<b>Art. 15582</b>  OEM 5112063 - 5169148 Anello per frizione cambio 116x73x4,5 mm - 4 fori
	<b>Art. 15174</b>  OEM 5109934 5109937 - 5161615 Anello per frizione di sterzo - in conglomerato - dentatura esterna 239x180x4,8 - 28 denti	<b>Art. 15389</b>  OEM 566519 Anello per frizione di sterzo - dentatura interna 229x171x2 mm - 21 denti	<b>Art. 15583</b>  OEM 5121348 Anello per disco PTO 280x165x3,5 mm 24 fori
	<b>Art. 15972</b>  OEM 1424135M94 Disco PTO rigido in ferodo 280x165x3 mm 25x22EV - Z.10 	<b>Art. 15642</b>  OEM 5145037 Disco PTO rigido in ferodo 280x165x3,5 mm 25x22EV - Z.10	<b>Art. 15668</b>  OEM 5109934 - 5109937 5161615 Anello per frizione di sterzo - sinterizzato - dentatura esterna 239x180x4 mm 28 denti
55.75 FRUTTETO - 55.75 VIGNETO - 55.75 MONTAGNA - 60.75 VIGNETO - 60.75 FRUTTETO - 60.75 MONTAGNA - 70.75 - 70.75 MONTAGNA - 80.75	<b>Art. 15176</b>  OEM 5109934 5109937 - 5161615 Anello per frizione di sterzo - in tessuto - dentatura esterna 239x180x4,8 mm 28 denti	<b>Art. 15174</b>  OEM 5109934 5109937 - 5161615 Anello per frizione di sterzo - in conglomerato - dentatura esterna 239x180x4,8 - 28 denti	<b>Art. 15389</b>  OEM 566519 Anello per frizione di sterzo - dentatura interna 229x171x2 mm - 21 denti
		<b>Art. 15668</b>  OEM 5109934 - 5109937 - 5161615 Anello per frizione di sterzo - sinterizzato - dentatura esterna 239x180x4 mm - 28 denti	<b>Art. 15582</b>  OEM 5112063 - 5169148 Anello per frizione cambio 116x73x4,5 mm - 4 fori



## FIAT ALLIS

7C - 7D (Mod. 01-02-03) 9 (Mod. 01-02-03) FA 100	<b>Art. 15171</b>  OEM 568399 Anello per frizione di sterzo - dentatura esterna - 309x214x5,4 101 denti		
4 - FL4 - FL4C	<b>Art. 15173</b>  OEM 588433 Anello per frizione centrale - dentatura esterna - 277x156x10 (1/3T) 45 denti	<b>Art. 15177</b>  OEM 569511 Anello per frizione centrale - dentatura esterna 277x166x7 - 45 denti	<b>Art. 15388</b>  OEM 571707 Anello per frizione cambio 88x48x4,5 mm 8 fori
	<b>Art. 15176</b>  OEM 5109934 5109937 - 5161615 Anello per frizione di sterzo - in tessuto - dentatura esterna 239x180x4,8 - 28 denti	<b>Art. 15174</b>  OEM 5109934 5109937 - 5161615 Anello per frizione di sterzo - in conglomerato - dentatura esterna 239x180x4,8 - 28 denti	<b>Art. 15389</b>  OEM 566519 Anello per frizione di sterzo - dentatura interna 229x171x2 mm 21 denti
FL6 - 5 (Mod. 01-02-03-04)	<b>Art. 15178</b>  OEM 568400 5104903 - 5161597 Anello per frizione di sterzo - dentatura esterna 271x201x5 - 89 denti	<b>Art. 15766</b>  OEM 547395 Controdisco 260x190x2,5 mm 65 denti	
10 - 14 - AD DB 14 FA120 - 150 - 200 FD5 - 7 - 9 - 14 - 14E FL5 - 7 - 9 - 12 - 14 FP40 / PL40 MOD.8 - 160.55	<b>Art. 15767</b>  OEM 586578 597258-79077633 Anello per frizione di sterzo sinterizzato bagno olio 305x213x4,3 - 95 denti	<b>Art. 15814</b>  OEM 4984755 - 79079550 - 582301 Anello per frizione di sterzo 208x145x3,6 - 68 denti	

# Frizioni e loro componenti

CLUTCHES - CLUTCH DISK - BEARING - COUPLING - LEVER - SET-REVISION

## FORD

















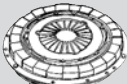



<p>5000</p> <p><b>new</b></p>	<p><b>Art. Kit 16216</b></p> <p><b>LUK</b></p>		<p>OEM 82010859 - D8NN7580BB - C5NN7580A</p> <p>Kit frizione completo Ø 310 con disco in tessuto organico Ø 300 Z.25, cuscinetto avanzamento 15514 e cuscinetto volano 36,5x68x15</p>	
<p>5635 6635 7635</p>	<p><b>Art. Kit 16075</b></p> <p><b>LUK</b></p>		<p>OEM</p> <p>Kit composto da: - Meccanismo 15787 - Disco 15788</p>	
	<p><b>Art. 15787</b></p> <p><b>LUK</b></p>	<p>OEM 87575337 (ex5189823)</p> <p>Meccanismo Piano Ø 310 mm</p>	<p><b>Art. 15788</b></p> <p><b>LUK</b></p> <p>OEM 5189825</p> <p>Disco di avanzamento cerametallico doppio segmento a 6 pale Ø 310 mm - 40x45 mm Z16</p>	<p><b>Art. 16009</b></p> <p><b>Viteo</b></p> <p>OEM 5166287</p> <p>Manicotto con reggispinta</p>
	<p><b>Art. 16076</b></p> <p><b>LUK</b></p>	<p>OEM</p> <p>Damper Ø 136 mm 22x25 mm - Z10</p>		
<p>5640 6640 7740 7840 8240 8340</p> <p><b>new</b></p>	<p><b>Art. Kit 16171</b></p> <p><b>LUK</b></p>		<p>OEM 9973697</p> <p>Kit completo monodisco Ø 330 con disco sinterizzato a 8 pale Ø 330 Z.10 mozzo 38x45x7</p>	

# Frizioni e loro componenti

CLUTCHES - CLUTCH DISK - BEARING - COUPLING - LEVER - SET-REVISION

11

## FORT























MOTOCOLTIVATORI SERIE 180	<b>Art. 15321</b> OEM  Frizione monodisco con molle a diaframma Piatto Ø 95 mm	<b>Art. 15189</b> OEM  Disco frizione rigido 94x61x1,5 mm 15x12EV Z.8	<b>Art. 15050</b> OEM  Cuscinetto reggispinta
	<b>Art. 15588</b> OEM  Frizione monodisco con molle a diaframma Piatto Ø 90 mm	<b>Art. 15525</b> OEM  Disco frizione rigido in ferodo 86x50x3,5 15x12EV Z.8	<b>Art. 15763</b> OEM  Disco frizione rigido in ferodo 89x55x11 mm 15x12EV Z.8 Ricambio per frizione 15588
MOTOCOLTIVATORE 108 - 202 con motore LOMBARDINI	<b>Art. 15717</b> OEM  Frizione conica Ø 103x79 mm Albero Ø 23 mm Conicità 1:5 15x12 mm - Z.8		
MOTOCOLTIVATORE SERIE 180 CON MOTORE JLO	<b>Art. 15590</b> OEM  Frizione monodisco con molle a diaframma Piatto Ø 90 mm	<b>Art. 15525</b> OEM  Disco frizione rigido 86x50x1,8 mm 15x12EV - Z.8	<b>Art. 15042</b> OEM  Manicotto con cuscinetto reggispinta
MOTAZAPPA 180 H	<b>Art. 15840</b> OEM  Frizione Ø 103x124 mm a 4 dischi 12x15EV - Z.8 Albero Ø 25 mm	<b>Art. 15630</b> OEM  Disco frizione sinterizzato Ø 93 mm	
MOTAZAPPA 180 MOTOCOLTIVATORE UNIVERSAL	<b>Art. 15841</b> OEM  Frizione Ø 103x90 mm a 4 dischi 12x15EV - Z.8 Albero Ø 23 mm	<b>Art. 15630</b> OEM  Disco frizione sinterizzato Ø 93 mm	
MOTAZAPPA 180 MOTOCOLTIVATORE UNIVERSAL vite lunga (dal 2000)	<b>Art. 15842</b> OEM  Frizione Ø 103x90 mm a 4 dischi 12x15EV - Z.8 Albero Ø 23	<b>Art. 15630</b> OEM  Disco frizione sinterizzato Ø 93 mm	
MOTOCOLTIVATORE 280 CD MOTAZAPPA MINITIGRE (motore benzina)	<b>Art. 15835</b> OEM  Frizione Ø 103x79 mm a 3 dischi 12x15EV - Z.8 Albero Ø 23 mm	<b>Art. 15630</b> OEM  Disco frizione sinterizzato Ø 93 mm	
MOTOCOLTIVATORE 280 CD MOTAZAPPA MINITIGRE (motore diesel)	<b>Art. 15836</b> OEM  Frizione Ø 103x79 mm a 4 dischi 12x15EV - Z.8 Albero Ø 23 mm	<b>Art. 15630</b> OEM  Disco frizione sinterizzato Ø 93 mm	
MOTOCOLTIVATORE 280 CD MOTAZAPPA (motore HONDA GX)	<b>Art. 15837</b> OEM  Frizione Ø 103x79 mm a 3 dischi 12x15EV - Z.8 Albero Ø 19,05 mm	<b>Art. 15630</b> OEM  Disco frizione sinterizzato Ø 93 mm	

(segue FORT)







# Frizioni e loro componenti

CLUTCHES - CLUTCH DISK - BEARING - COUPLING - LEVER - SET-REVISION

## segue FORT

MOTOCOLTIVATORE 280 CD MOTOZAPPA (motore HONDA GC)	<b>Art. 15838</b>  OEM Frizione Ø 103x91 mm a 3 dischi 12x15EV - Z.8 Albero Ø 19,05 mm	<b>Art. 15630</b>  OEM Disco frizione sinterizzato Ø 93 mm	
MOTOCOLTIVATORE 280	<b>Art. 15839</b>  OEM Frizione Ø 103x113 mm a 4 dischi 12x15EV - Z.8 Albero Ø 25 mm	<b>Art. 15630</b>  OEM Disco frizione sinterizzato Ø 93 mm	
MOTOCOLTIVATORE LEONE	<b>Art. 15843</b>  OEM Frizione Ø 103x90 mm a 5 dischi 12x15EV - Z.8 Albero Ø 24 mm	<b>Art. 15630</b>  OEM Disco frizione sinterizzato Ø 93 mm	
MOTOZAPPA - TIGROTTO - EL TIGRE	<b>Art. 15318</b>  Frizione conica Ø 103x69 mm Albero Ø 22,5 mm Conicità 1:5 15x12EV - Z.8	<b>Art. 15629</b>  OEM Manicotto con cuscinetto reggispinta	
MOTOZAPPA MOTOFALCIATRICE	<b>Art. 15002</b>  OEM Frizione monodisco con molle a diaframma Piatto Ø 110 mm	<b>Art. 15019</b>  OEM Disco frizione rigido 110x58x1,5 mm 15x12EV - Z.8	<b>Art. 15057</b>  OEM Leva a forcella
	<b>Art. 15050</b>  OEM Cuscinetto reggispinta	<b>Art. 15042</b>  OEM Manicotto con cuscinetto reggispinta	
MOTOCOLTIVATORI TIGROTTO	<b>Art. 15339</b>  Frizione bidisco completa di disco centrale Piatto Ø 110 mm	<b>Art. 15019</b>  OEM Disco frizione rigido 110x58x1,5 mm 15x12EV - Z.8	<b>Art. 15057</b>  OEM Leva a forcella
	<b>Art. 15050</b>  OEM Cuscinetto reggispinta	<b>Art. 15042</b>  OEM Manicotto con cuscinetto reggispinta	
CENTAURO	<b>Art. 15004</b>  OEM Frizione monodisco a molle elicoidali Piatto Ø 160 mm	<b>Art. 15025</b>  OEM Disco frizione rigido 160x110x4,3 mm 19x15,5x3 mm - Z.10	<b>Art. 15059</b>  OEM Leva a forcella
	<b>Art. 15051</b>  OEM Cuscinetto reggispinta	<b>Art. 15048</b>  OEM Manicotto	

## FOTON













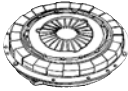

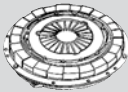

6000 - 700 - 704 - FT 504 / 604 / 650 / 654 / 700 / 704 / 750A / 750B / 754A / 754B / 804 / 820 / 824 - JM 654 / 754 - ND 824 - TD 750 / 800 / 804 / 824	<b>Art. Kit 15929</b>   OEM	 OEM Kit frizione doppia a 6 leve con disco interno e disco PTO Ø 280 mm
TD 1004 / 854 / 900 / 904 / 920 - TF1054 - 1154	<b>Art. Kit 15932</b>   OEM	 OEM Kit frizione doppia a 6 leve con disco interno e disco PTO Ø 310 mm

# Frizioni e loro componenti









CLUTCHES - CLUTCH DISK - BEARING - COUPLING - LEVER - SET-REVISION

11

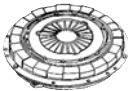
## F & M MATRAS (FRANCESCHINI & MASINA)

MOTOZAPPA (160 cc)	<b>Art. 15618</b> OEM  Frizione Ø 110 mm a dischi multipli con 4 dischi ed ingranaggio	<b>Art. 15599</b> OEM  Frizione Ø 110 mm a dischi multipli con 4 dischi e senza ingranaggio	<b>Art. 15600</b> OEM  Serie dischi completa composta da 4 dischi 104x78x3 mm
MOTOZAPPA R5 MOTOCOLTIVATORE 820	<b>Art. 15601</b> OEM  Frizione monodisco con molle a diaframma Piatto Ø 90 mm	<b>Art. 15602</b> OEM  Disco frizione rigido 86x50x3,5 mm 17x14EV - Z.9	<b>Art. 15603</b> OEM  Disco frizione rigido 94x60x3 mm 17x14EV - Z.9
MOTOZAPPA R5 CON MOTORE JLO	<b>Art. 15619</b> OEM  Frizione monodisco con molle a diaframma Piatto Ø 90 mm	<b>Art. 15602</b> OEM  Disco frizione rigido 86x50x3,5 mm 17x14EV - Z.9	<b>Art. 15758</b> OEM  Manicotto con cuscinetto reggispinta
MOTOZAPPA	<b>Art. 15591</b> OEM  Frizione conica Ø 103x85 mm Albero Ø 22,5 mm Conicità 1:5 17x14EV - Z.9		
MOTOZAPPA R 100	<b>Art. 15002</b> OEM  Frizione monodisco con molle a diaframma Piatto Ø 110 mm	<b>Art. 15019</b> OEM  Disco frizione rigido 110x58x1,5 mm 15x12EV - Z.8	<b>Art. 15042</b> OEM  Manicotto con cuscinetto reggispinta
MOTOZAPPA L 300	<b>Art. 15627</b> OEM  Frizione monodisco con molle elicoidali Piatto Ø 160 mm	<b>Art. 15040</b> OEM  Disco frizione rigido in ferodo 160x110x3,2 mm 22x19x3,5 mm - Z.10	
MOTOZAPPA R5	<b>Art. 15670</b> OEM  Frizione conica Ø 104 mm - H 68 mm Albero Ø 22,5 mm Conicità 1:5 17x14EV - Z.9	<b>Art. 15757</b> OEM  Disco frizione rigido 94x61x1,5 mm 17x14 mm - Z.9	<b>Art. 15758</b> OEM  Manicotto con cuscinetto reggispinta

## GOLDONI











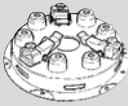



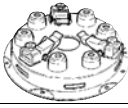













SERIE 100 - 600 JOLLY - MONDIAL - UNO - FC (intercambiabile con 00005970)	<b>Art. 15844</b> OEM  Frizione Ø 103x62 mm a dischi multipli con 3 dischi 12x15EV - Z.8 Albero Ø 23 mm	<b>Art. 63868</b> OEM 06200093  Cuscinetto	
MOTOCOLTIVATORI: JOLLY JUNIOR - JOLLY SUPER - JOLLY PROFESS. - TWIST - JOKER (dalla serie P in avanti)	<b>Art. 15274</b> OEM  02020015 Frizione monodisco con molle a diaframma Piatto Ø 110 mm Fornito senza disco	<b>Art. 15022</b> OEM  06300063 Disco frizione rigido Ø 110 mm sinterizzato 15x12EV - Z.8	<b>Art. 15754</b> OEM  00017181 Manicotto con cuscinetto reggispinta
	<b>Art. 16207</b> OEM 00059242  Manicotto con cuscinetto reggispinta		
MOTOCOLTIVATORI SPECIAL LUX (FINO ALLA SERIE G)  (segue GOLDONI)	<b>Art. 15592</b> OEM  02020016 Frizione bidisco con molle a diaframma Piatto Ø 110 mm (Fornito senza disco 15022)	<b>Art. 15022</b> OEM  06300063 Disco frizione rigido Ø 110 mm sinterizzato 15x12EV - Z.8	<b>Art. 15754</b> OEM  00017181 Manicotto con cuscinetto reggispinta



# Frizioni e loro componenti

CLUTCHES - CLUTCH DISK - BEARING - COUPLING - LEVER - SET-REVISION

## segue GOLDONI

MOTOCOLTIVATORI: SPECIAL - SUPER SPECIAL - SPECIAL LUX - (dalla serie H in avanti)	<b>Art. 15004</b>  OEM 02020018 Frizione monodisco a molle elicoidali Piatto Ø 160 mm	<b>Art. 15025</b>  OEM 00007474 06300116 Disco frizione rigido 160x110x4,3 mm 19x15,5x3 mm - Z.10	<b>Art. 15059</b>  OEM 06300017 Leva a forcella	
	<b>Art. 15051</b>  OEM 06300013 Cuscinetto reggispinta	<b>Art. 15048</b>  OEM 06300011 Manicotto		
MOTOCOLTIVATORI: EXPORT - SERIE 500 - SERIE 700	<b>Art. 15005</b>  OEM 02020020 Frizione monodisco a molle elicoidali Piatto Ø 187 mm	<b>Art. 15026</b>  OEM 06300045 Disco frizione rigido 184x127x3,8 mm 19x15,5x3 mm - Z.10	<b>Art. 15060</b>  OEM 00008313 Leva a forcella	
	<b>Art. 15052</b>  OEM 06300023 Cuscinetto reggispinta 68x36x19 mm <b>PER EXPORT 15051</b>	<b>Art. 15047</b>  OEM 06300022 Manicotto  <b>PER EXPORT 15048</b>	<b>Art. 16185</b>  OEM 00001757 Vite azionamento forcella frizione	
TRATTORINI: 926 - 933 RS/DT - 224 - 226 - 228 - 230 - 233 - 518T - 520T - 521T - MOTOAGRICOLE: SERIE 500 - 500 RT - 400 - 500T - 800 - 900 BASE 20 EURO TRANSCAR - TRANSPORTER UNIVERSAL UNIVERSALCAR	<b>Art. 15008</b>  OEM 02020021 Frizione monodisco a molle elicoidali Piatto Ø 187 mm	<b>Art. 15026</b>  OEM 06300045 Disco frizione rigido 184x127x3,8 mm 19x15,5x3 mm - Z.10 Non applicabile ai mod. 926 - 933 RS/DT	<b>Art. 15060</b>  OEM 00008313 Leva a forcella	
	<b>Art. 15141</b>  OEM 06300048 Disco frizione rigido 184x127x3,8 mm 22x18x3,5 mm - Z.10 Solo per mod. 926 - 933 RS/DT	<b>Art. 16003</b>  OEM 06300075 Disco frizione rigido con molle 184x127x3,8 mm 22x18x3,5 mm - Z.10 Solo per mod. 926 - 933 RS/DT	<b>Art. 15052</b>  OEM 06300023 Cuscinetto reggispinta 68x36x19 mm	
	<b>Art. 15047</b>  OEM 06300022 Manicotto		<b>Art. 16185</b>  OEM 00001757 Vite azionamento forcella frizione	
TRATTORINI: 236 - 238 - 240 - 1038 - 800 - 834 - 900 - 945 RS/DT - 1000 - 1045 R MOTOAGRICOLE: TRANSCAR TRANSPORTER EURO UNIVERSAL	<b>Art. 15009</b>  OEM 02020022 Frizione monodisco a molle elicoidali Piatto Ø 215 mm	<b>Art. 15027</b>  OEM 06300038 Disco frizione rigido 216x152x3,5 mm 22x18x3,3 mm - Z.10	<b>Art. 15060</b>  OEM 00008313 Leva a forcella	
	<b>Art. 15052</b>  OEM 06300023 Cuscinetto reggispinta 68x36x19 mm	<b>Art. 15047</b>  OEM 06300022 Manicotto	<b>Art. 16185</b>  OEM 00001757 Vite azionamento forcella frizione	
IDEA	<b>Art. 15720</b>  OEM 02020035 Meccanismo a 3 leve completo di disco centrale in ferodo. Piatto Ø 180 mm	<b>Art. 15721</b>  OEM 06300087 Disco frizione rigido centrale 180x127x3,8 mm 35x31 mm - Z.18	<b>Art. 15272</b>  OEM 06300080 Cuscinetto reggispinta piccolo 82x50x28	
		<b>Art. 15707</b>  OEM 06300086 Disco PTO in ferodo 180x127x3,8 mm 20x17 mm - Z.12	<b>Art. 15808</b>  OEM 06300081 Cuscinetto reggispinta grande 117x75x27	

































(segue GOLDONI)

# Frizioni e loro componenti

CLUTCHES - CLUTCH DISK - BEARING - COUPLING - LEVER - SET-REVISION

11

























## segue GOLDONI

TRATTRICE MAXTER TRANSCAR CLUSTER	 <b>Art. 15724</b> OEM 02020046 Frizione monodisco a molle elicoidali Piatto Ø 280 mm	 <b>Art. 15725</b> OEM 06300118 - 06300105 Disco frizione con molle 280x162x3,5 mm 35x31 mm - Z.18 <b>Per CLUSTER - MAXTER</b>	 <b>Art. 16161</b> OEM 06300108 - 06300119 Disco frizione 280x172x3,8 mm 27x30 mm - Z.16 <b>Per TRANSCAR 70</b>
	 <b>Art. 16197</b> OEM 02020041 Frizione a diaframma Ø 230 mm <b>Per MAXTER 60</b>	 <b>Art. 16048</b> OEM 06300093 Disco frizione rigido 230x155x3,3 mm 28x32 - Z.17 <b>Per MAXTER 60</b>	 <b>Art. 15980</b> OEM 06300088 - 06300117 - 06300109 Cuscinetto reggispinta
TRATTORI: SERIE 1050 - SERIE 1055 MOTOAGRICOLE: TRANSCAR 55 CINGOLO EURO	 <b>Art. 15010</b> OEM 02020023 Frizione monodisco a molle elicoidali Piatto Ø 215 mm	 <b>Art. 15027</b> OEM 06300038 Disco frizione rigido 216x152x3,5 mm 22x18x3,5 mm - Z.10	 <b>Art. 15060</b> OEM 00008313 Leva a forcella
	 <b>Art. 15052</b> OEM 06300023 Cuscinetto reggispinta 68x36x19 mm	 <b>Art. 15047</b> OEM 06300022 Manicotto	
TRANSCAR 60	 <b>Art. 15010</b> OEM 02020023 Frizione monodisco a molle elicoidali Piatto Ø 215 mm	 <b>Art. 16005</b> OEM 06300072 Disco PTO con parastrappi Ø 215 mm - 22x18 - Z.10	 <b>Art. 15052</b> OEM 06300023 Cuscinetto reggispinta 68x36x19 mm
	 <b>Art. 15047</b> OEM 06300022 Manicotto		
QUASAR 70/85/90 STAR 65/75/85/100 QUADRIFOGLIO STAR 4000 QUAD.	 <b>Art. 15991</b> OEM 00037256 Meccanismo a 6 leve Ø 280 mm 36x40 mm - Z.20 + disco PTO (15988)	 <b>Art. 15988</b> OEM 06300103 - 06300121 Disco PTO rigido Ø 280 mm 22x25 mm - Z.14	 <b>Art. 15989</b> OEM 06300102 Disco Frizione lato cambio, ammortizzato Ø 280 mm 36x40 mm - Z.20
		 <b>Art. 15755</b> OEM 06200155 Cuscinetto reggispinta 96,5x65x23,5 mm	 <b>Art. 15756</b> OEM 06300056 Cuscinetto reggispinta PTO 106x139,5x25 mm
3045 - 3050 - 3445 - 3450 STAR 3050 / 3070/V SERIE COMPACT	 <b>Art. 15992</b> OEM 00035387 00035385 Meccanismo a 6 leve Ø 225 mm 31x35 mm - Z.18 + disco PTO (15993)	 <b>Art. 15993</b> OEM 06300082 Disco PTO Ø 225 mm 20x23 mm - Z.20 <b>Per frizione LUK</b>	 <b>Art. 15755</b> OEM 06200155 Cuscinetto reggispinta 96,5x65x23,5 mm
		 <b>Art. 16004</b> OEM 06300097 Disco frizione organico cambio con molle Ø 225 mm 35x31 mm - Z.18 <b>Per frizione LUK</b>	 <b>Art. 15756</b> OEM 06300056 Cuscinetto reggispinta PTO 106x139,5x25 mm
ASTER RONIN  ARBOS MR3040 MR3050	 <b>Art. 16162</b> OEM 02020048 Meccanismo + disco PDF 9"x9"	 <b>Art. 16163</b> OEM 06300112 Disco frizione cambio 225x150x3,8 mm 31x35 mm - Z.16	 <b>Art. 16164</b> OEM 06300127 - 06300111 Disco frizione PDF 225x150x3 mm 17x20 mm - Z.12
	 <b>Art. 15980</b> OEM 06300088 - 06300117 - 06300109 - 06300124 Cuscinetto reggispinta	 <b>Art. 16201</b> OEM 06300110 - 06300123 Cuscinetto reggispinta 128x80x31	 <b>Art. 62558</b> OEM 06200062 Cuscinetto 35x62x14 mm
(segue GOLDONI)			 <b>Art. FAG 63844</b>

# Frizioni e loro componenti

CLUTCHES - CLUTCH DISK - BEARING - COUPLING - LEVER - SET-REVISION



















## segue GOLDONI

3460 - 662 - 762 - 764 - 772 - 774 STAR 3070 STAR 3000V STAR 75 3000V STAR JO - 70	<b>Art. 15994</b> 	OEM 00035289 Meccanismo a 6 leve Ø 250 mm 20x23 mm - Z.20 + disco PTO	<b>Art. 15995</b> 	OEM 06300113 Disco PTO rigido organico Ø 250 mm 20x23 mm - Z.20	<b>Art. 15996</b> 	OEM 06300096 Disco Frizione lato cambio, ammortizzato a 18 molle - Ø 250 mm 35x31 mm - Z.18		
			<b>Art. 15755</b> 	OEM 06200155 Cuscinetto reggispinta 96,5x65x23,5 mm	<b>Art. 15756</b> 	OEM 06300056 Cuscinetto reggispinta PTO 106x139,5x25 mm		
STAR 3000V serie D-E QUASAR serie A-B STAR serie A-B	<b>Art. 15997</b> 	OEM 00035287 Meccanismo in ghisa a 6 leve Ø 280 mm + disco PTO (15998)	<b>Art. 15998</b> 	OEM 06300091 Disco PTO rigido organico Ø 280 mm 20x23 mm - Z.20	<b>Art. 15999</b> 	OEM 06300095 Disco cambio organico a molle Ø 280 mm 31x35 mm - Z.18		
			<b>Art. 15755</b> 	OEM 06200155 Cuscinetto reggispinta 96,5x65x23,5 mm	<b>Art. 15756</b> 	OEM 06300056 Cuscinetto reggispinta PTO 106x139,5x25 mm		
COMPACT 664 STAR 3000 STAR 3000 LE STAR 3060 STAR 3060 C	<b>Art. Kit 16000</b>  	 	OEM 00038911 00059896 - 00062806 Meccanismo doppio a 6 leve Ø 230 mm - 36x40 mm - Z.20 - + disco PTO (16001)					
			<b>Art. 16176</b> 	OEM 06300049 Disco PTO lato volano Ø 216 mm 23x20 mm - Z.20	<b>Art. 16001</b> 	OEM 06300107 06300122 Disco PTO lato volano Ø 225 mm 22x25 mm - Z.14	<b>Art. 16002</b> 	OEM 06300106 06300125 Disco lato cambio Ø 225 mm 36x40 mm - Z.20
				<b>Art. 15755</b> 	OEM 06200155 Cuscinetto reggispinta 96,5x65x23,5 mm	<b>Art. 15756</b> 	OEM 06300056 Cuscinetto reggispinta PTO 106x139,5x25 mm	
STAR 3000 STAR 3000 LE STAR 3080 ENERGY 80 STAR 50-70 STAR QUADRIFOGLIO	<b>Art. Kit 16006</b> 		OEM 00037254 - 00061035 Meccanismo doppio Frizione Ø 250/250 6 leve in ghisa + disco PTO (16007) Ø 250 mm - 40x36 mm - Z.20					
			<b>Art. 16007</b> 	OEM 06300101 - 06300120 Disco PTO rigido organico Ø 250 mm 25x22 mm - Z.14	<b>Art. 16008</b> 	OEM 06300100 Disco lato cambio organico a molle Ø 250 mm 40x36 mm - Z.20		
			<b>Art. 15755</b> 	OEM 06200155 Cuscinetto reggispinta 96,5x65x23,5 mm	<b>Art. 15756</b> 	OEM 06300056 Cuscinetto reggispinta PTO 106x139,5x25 mm		

# Frizioni e loro componenti

CLUTCHES - CLUTCH DISK - BEARING - COUPLING - LEVER - SET-REVISION

## GOLDONI CINGOLATI

3.40 3.45 C45	 <b>Art. 15010</b> OEM 02020023 Frizione monodisco a molle elicoidali Piatto Ø 215 mm	 <b>Art. 15325</b> OEM 00660774 Disco frizione rigido 216x152x3,8 mm 26x21x4 mm - Z.10	 <b>Art. 16206</b> OEM 00660190 Anello frizione sterzo in tessuto 193+134+4,6 mm 63 denti
	 <b>Art. 63864</b> OEM 06200203 Cuscinetto		
3.60 C60	 <b>Art. 15350</b> OEM 00661173 Frizione monodisco a molle elicoidali Piatto Ø 280 mm	 <b>Art. 15169</b> OEM 00661174 Disco frizione rigido 279x171x4,3 mm 35x29x5,5 mm Z.10	 <b>Art. 15417</b> OEM 00660046 Anello frizione di sterzo in tessuto - dentatura esterna 219,2x152x4,7 mm 71 denti
	 <b>Art. 63868</b> OEM 06200093 Cuscinetto		
C55 C75 Lander 55-75	 <b>Art. 15997</b> OEM 00035287 Meccanismo in ghisa a 6 leve Ø 280 mm + disco PTO (15998)	 <b>Art. 15998</b> OEM 06300091 Disco PTO rigido organico Ø 280 mm 20x23 mm - Z.20	 <b>Art. 15999</b> OEM 06300095 Disco cambio organico a molle Ø 280 mm 31x35 mm - Z.18
		 <b>Art. 15755</b> OEM 06200155 Cuscinetto reggispinta 96,5x65x23,5 mm	 <b>Art. 15756</b> OEM 06300056 Cuscinetto reggispinta PTO 106x139,5x25 mm
	 <b>Art. 15994</b> OEM 00035289 Meccanismo a 6 leve Ø 250 mm 20x23 mm - Z.20 + disco PTO (15995)	 <b>Art. 15995</b> OEM 06300113 Disco PTO rigido organico Ø 250 mm 20x23 mm - Z.20	 <b>Art. 15996</b> OEM 06300096 Disco Frizione lato cambio, ammortizzato a 18 molle Ø 250 mm 35x31 mm - Z.18
		 <b>Art. 15755</b> OEM 06200155 Cuscinetto reggispinta 96,5x65x23,5 mm	 <b>Art. 15756</b> OEM 06300056 Cuscinetto reggispinta PTO 106x139,5x25 mm



























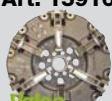

# Frizioni e loro componenti

CLUTCHES - CLUTCH DISK - BEARING - COUPLING - LEVER - SET-REVISION

11

## HÜRLIMANN





















H 355 - H355 F - H 360 - H 470	<b>Art. 15722</b>  LUK	OEM 008.5531.4 Meccanismo a 6 leve. Piatto Ø 280 mm (11")	<b>Art. 15397</b>  LUK	OEM 177.2250.3 144.2250.3 Disco centrale rigido in ferodo 280x165x3,5 mm 40x36EV - Z.20	<b>Art. 15404</b> OEM  Cuscinetto reggispinta 95x50x21,5 mm
			<b>Art. 15121</b>  LUK	OEM 008.4751.3 422.2222.3/20 Disco PTO rigido, in ferodo 280x165x3,5 mm 25x22EV - Z.14	
H 480			<b>Art. 15392</b>  LUK	OEM 195.2250.3 Disco centrale metalc. a 6 pale - rigido Ø 310 mm sinterizzato 40x36EV - Z.20	
H 5160 - H 6160 -	<b>Art. Kit 15394</b>  LUK	 LUK	 LUK	OEM 212.2358.4/10 KIT meccanismo presa di movimento con disco	<b>Art. 15293</b> OEM 212.2359.3/10  Vitech Disco centrale metalceramico a 7 pale Rigido Ø 350 mm sinterizzato 50x45EV - Z.24
	<b>Art. 15445</b>  LUK	OEM 269.2313.3 Disco presa di movimento rigido in ferodo 352x195x4,3 mm 50x45EV - Z.24	<b>Art. 15410</b>  Vitech	OEM 250.6533.3 Manicotto con cuscinetto reggispinta	<b>Art. 15883</b> OEM 2.2999.510.0  Vitech 2.2999.207.0 2.2999.443.0 112x65x42 mm Cuscinetto reggispinta
XB75 XB85-T-TB XB95-T-TB XT95 XT105 XT110	<b>Art. Kit 16041</b>  LUK	 LUK	 LUK	 LUK	OEM 0.012.2621.4  Kit composto da: - Meccanismo 15923 - Disco centrale 15924 - Cuscinetto 15744
	<b>Art. 15923</b>  LUK	OEM 0.012.7094.3 Meccanismo frizione con molle a diaframma Ø 330 (13")	<b>Art. 15924</b>  LUK	OEM 0.012.7095.3/10 Disco centrale a 5 pale 36,5x41 mm - Z.24	<b>Art. 15744</b> OEM  2.2999.475.0 Cuscinetto reggispinta 90x55x22 mm
H 361 XE 306 XE 355 - 365F	<b>Art. 15916</b>  Vitech	OEM 0.012.2567.4 0.019.8634.4 Meccanismo a 6 leve completo di disco Ø 280 mm	<b>Art. 15917</b>  LUK	OEM 0.011.9067.3 Disco Ø 280 mm 22x25 mm - 14 cave	<b>Art. 15990</b> OEM  LUK 2.2999.153.0/10 Cuscinetto reggispinta cambio 90x50x22 mm
					<b>Art. 15280</b> OEM  2.2999.153.0/10 Cuscinetto reggispinta cambio 90x50x22 mm
H 351	<b>Art. 15912</b>  LUK	OEM 151.2222.3 0.015.6382.3 0.008.4803.3 Disco frizione rigido interno org. Ø 230 40x35 mm - Z.14	<b>Art. 15913</b>  LUK	OEM 151.2213.3 0.014.9429.3 0.008.4804.3 Disco lato cambio esterno Ø 250 25x20x4 mm - Z.10	
M 490	<b>Art. Kit 16107</b>  LUK	 LUK	 LUK	OEM 0.015.6389.4 0.176.2351.4/10 KIT meccanismo con disco Ø 330 mm	

(segue HÜRLIMANN)







# Frizioni e loro componenti

CLUTCHES - CLUTCH DISK - BEARING - COUPLING - LEVER - SET-REVISION





## segue HÜRLIMANN

H 476 - 476.4 H 478 - 478.4 - 478 T Prestige H 486 H 488 H 488 T Prestige XT 909	<b>Art. 15647</b>  LUK	OEM 0.008.4184.3 3713531M1 0.014.9423.3/10 Meccanismo con molle a diaframma Piatto Ø 330 mm	<b>Art. 15964</b>  LUK	OEM Disco centrale in ferodo con molle parastrappi 330x196x4,2 mm 41x36,5EV - Z.24	<b>Art. 15803</b> 	OEM Disco centrale in ferodo con molle parastrappi 330x196x4,2 mm 41x36,5EV - Z.24
	<b>Art. 15895</b>  LUK	OEM 007.7928.3 Disco centrale metalceramico 6 pale con parastrappi Ø310 mm sinterizzato 41x36,5 mm - Z.24	<b>Art. 15965</b>  LUK	OEM 0.014.9432.3 Disco centrale metalceramico a 6 p. con molle parastrappi Ø 330 mm sinterizzato 41x45,3 mm - Z.21	<b>Art. 15749</b>  Per gli altri modelli	OEM 0.014.9432.3 Disco centrale metalceramico a 6 p. con molle parastrappi Ø 330 mm sinterizzato 41x45,3 mm - Z.21
			<b>Art. 15984</b>  LUK	OEM 0.016.6105.3 Disco centrale metalceramico a 6 pale con molle parastrappi Ø 330 mm sinterizzato 41x36,5EV - Z.24	<b>Art. 15673</b> 	OEM 009.6533.3 Disco centrale metalceramico a 6 pale con molle parastrappi Ø 330 mm sinterizzato 41x36,5EV - Z.24
			<b>Art. 15883</b>  LUK	OEM 2.2999.510.0 2.2999.207.0 2.2999.443.0 112x65x42 mm Cuscinetto reggispinta	<b>Art. 15744</b> 	OEM 2.2999.475.0 Cuscinetto reggispinta 90x55x22 mm
M478.4 PRESTIGE 478/488 XB ELITE 6115 XT 908/909/910.4/ 910.6 /911	<b>Art. 15954</b>  LUK	OEM 0.010.6912.3/10 0.015.6386.3 Meccanismo con molle a diaframma Piatto Ø 350 mm	<b>Art. 15953</b>  LUK	OEM 0.007.7929.3/10 0.015.6328.3 Disco Ø 350 mm 36,5x41 mm - Z.24	<b>Art. 15983</b>  LUK	OEM 0.007.7930.3/10  Disco Ø 350 mm 41x45 mm - Z.21
			<b>Art. 16010</b>  LUK	OEM 0.015.6381.3 Disco Ø 330 mm 36,5x41 mm - Z.24	<b>Art. 15744</b> 	OEM 2.2999.475.0 Cuscinetto reggispinta 90x55x22 mm
PRINCE	<b>Art. Kit 15987</b>  LUK	 LUK	 LUK	OEM 0.012.5851.4/20 Kit frizione doppia a 6 leve con disco interno Ø 230 mm		
			<b>Art. 62952</b>  LUK	OEM Cuscinetto reggispinta PTO 75x115x20 mm	<b>Art. 62577</b> 	OEM Cuscinetto volano 15x35x11 mm
			<b>Art. FAG 63897</b>		<b>Art. FAG 63863</b>	

## IMER

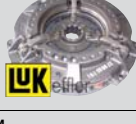
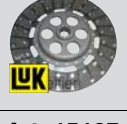
MOTOZAPPA SERIE 115	<b>Art. 15002</b>  LUK	Meccanismo monodisco a molle elicoidali Piatto Ø 110 mm	<b>Art. 15019</b>  LUK	Disco frizione rigido in ferodo 110x58x1,5 mm 15x12EV - Z.8	<b>Art. 15042</b> 	Manicotto con cuscinetto reggispinta
MOTOZAPPA SERIE 270	<b>Art. 15296</b>  LUK	OEM  Meccanismo monodisco a molle elicoidali Piatto Ø 184 mm	<b>Art. 15628</b>  LUK	OEM  Disco frizione con molle parastrappi 184x127x8 mm 22x19EV - Z.13	<b>Art. 15052</b> 	OEM Cuscinetto reggispinta 68x36x19 mm
					<b>Art. 15047</b> 	OEM  Manicotto

## IMT

539	<b>Art. Kit 16169</b>  LUK	 LUK	 LUK	OEM 962193M94  Kit composto da: - Meccanismo 15901 - Disco PTO 15183	<b>Art. 15514</b> 	OEM  Cuscinetto reggispinta
	<b>Art. 15901</b>  LUK	OEM 3620401M91 Meccanismo	<b>Art. 15127</b>  LUK	OEM 899823M91 1753753M92 - 3620411M91 Disco PTO rigido in ferodo 225x145x3,5 mm 44x38x7 mm -Z.10	<b>Art. 15183</b> 	OEM 890302M91 3620410M91 Disco frizione centrale rigido in ferodo 273x178x3,5 mm 29x23x4 mm -Z.10

























Gli articoli qui descritti, prodotti da e/o per conto di CERMAG, sono da intendersi adattabili, quindi non originali, ai marchi indicati secondo REG. CE 1400/2002  
All items described here, produced by and/or on behalf of CERMAG, are to be understood as adaptable, therefore not original, to the brands indicated according to REG. EC 1400/2002

# Frizioni e loro componenti



CLUTCHES - CLUTCH DISK - BEARING - COUPLING - LEVER - SET-REVISION

11

## ITMA

4RM SIRIO - G 215 AC2	<b>Art. 15010</b> 	OEM 00661238 Meccanismo monodisco a molle elicoidali Piatto Ø 217 mm	<b>Art. 15027</b> 	OEM 00651814 Disco frizione rigido 216x152x3,5 mm 22x18 mm - Z.10	<b>Art. 15052</b> 	OEM 00651815 Cuscinetto reggispinta 68x36x19 mm
NIKE 180 - 280 - 300 - 301 - 302 - 322 - F215	<b>Art. 15009</b> 	OEM 00651375 Frizione monodisco a molle elicoidali Piatto Ø 215 mm	<b>Art. 15347</b> 	OEM 00650990 Disco frizione rigido 215x154x4 mm 31x27EV - Z.11	<b>Art. 15055</b> 	OEM 00660775 Cuscinetto reggispinta
A35 - 30FL - 235 - A302 - A322 - F215.4	<b>Art. 15009</b> 	OEM 00651375 Frizione monodisco a molle elicoidali Piatto Ø 215 mm	<b>Art. 15325</b> 	OEM 00660774 Disco frizione rigido 216x152x3,8 mm 26x21x4 mm - Z.10	<b>Art. 15055</b> 	OEM 00660775 Cuscinetto reggispinta
NIKE 250 - 320 - 350 - 351 - 401 - L250	<b>Art. 15345</b> 	OEM 00660545 49624 Frizione monodisco a molle elicoidali Piatto Ø 250 mm	<b>Art. 15348</b> 	OEM 00651122 Disco frizione rigido 250x157x4,3 mm 35x30EV - Z.12		
352 - 453 - 500 - 503 - L250	<b>Art. 15345</b> 	OEM 00660545 49624 Frizione monodisco a molle elicoidali Piatto Ø 250 mm	<b>Art. 15234</b> 	OEM 00660544 Disco frizione rigido 250x155x4,3 mm 35x29x5,5 mm Z.10	<b>Art. 15980</b> 	OEM 06300117 Cuscinetto reggispinta
A553 - A654 - H280.4 - 600 - 700 - (Frizione monodisco)	<b>Art. 15350</b> 	OEM 00661173 Frizione monodisco a molle elicoidali Piatto Ø 280 mm	<b>Art. 15169</b> 	OEM 00661174 Disco frizione rigido 279x171x4,3 mm 35x29x5,5 mm Z.10		
600 - 700 Frizione doppia	<b>Art. 15147</b> 	OEM 00652253 Disco centrale rigido in ferodo 280x165x3,5 mm 40x35EV - Z.14	<b>Art. 15972</b>  LUK effier	OEM 00652252 Disco PTO rigido in ferodo 280x165x3,5 mm 25x22EV - Z.10	<b>Art. 15642</b> 	OEM 00652252 Disco PTO rigido in ferodo 280x165x3,5 mm 25x22EV - Z.10
3.55 - 3.65	<b>Art. 15147</b> 	Disco centrale con molle parastrappi in ferodo 280x165x3,8 mm 40x35EV - Z.14	<b>Art. 15351</b> 	OEM 00652264 Disco PTO rigido in ferodo 280x165x3,5 mm 22x19EV - Z.10	<b>Art. 62951</b>  <b>Art. FAG 63896</b>	OEM 06200222 Cuscinetto reggispinta PTO 70x110x20 mm
3.75 H - 3.85 TURBO	<b>Art. 15352</b> 	OEM Disco centrale rigido metalceramico Ø 310 mm sinterizzato 40x36EV - Z.20	<b>Art. 15353</b> 	OEM 00652256 Disco presa di fresa rigido in ferodo 310x175x3,5 mm 25x22EV - Z.14		

## JOHN DEERE

































2040 - 2140 - 2650 - 2850 - 3040 - 3050 - 3140 - 3350 - 3640 - 3650	<b>Art. 15571</b>  LUK	OEM AL68485 Frizione in ghisa con PTO fissa - volano a tazza - piattello reggispinta Piatto Ø 330 mm Z.27	<b>Art. 15573</b>  LUK	OEM AL68022 AL61754 Disco avanzamento metalceramico a 5 pale con molle parastrappi Ø 327 mm - Z.10	<b>Art. 15896</b>  LUK	OEM AL70272 Disco avanzamento metalceramico a 6 pale Ø 330 mm - Z.10
	<b>Art. 15572</b>  LUK	OEM AL33126 Disco centrale in ferodo con molle parastrappi Ø 320 mm - Z.10	<b>Art. 15936</b>  LUK	OEM Cuscinetto 58x96x57 mm	<b>Art. 62577</b>  <b>Art. FAG 63863</b>	OEM Cuscinetto volano 15x35x11 mm
			<b>Art. 16150</b>  LUK	OEM AL120029 Reggispinta idraulico	<b>Art. 15744</b> 	OEM CE13883 Cuscinetto reggispinta 55x90x22 mm



# Frizioni e loro componenti

CLUTCHES - CLUTCH DISK - BEARING - COUPLING - LEVER - SET-REVISION

## segue JOHN DEERE







5300/N - 5400/N - 5500/N (frizione OMG) (segue JOHN DEERE)	<b>Art. 16057</b>  OEM ER135120 Meccanismo frizione compatto completo di disco centrale 34x40- Z.12 e disco PDF 22x19 - Z.13 Ø 280 mm	<b>Art. 62597</b>  OEM ER026007 - JD33004  Cuscinetto avanzamento 45x75x16 mm	<b>Art. 63363</b>  OEM ER027659 - AZ46129  Cuscinetto PTO 100x65x18 mm	
	<b>Art. 62580</b>  OEM JD9449  Cuscinetto volano 17x40x12 mm			
5300/N - 5400/N - 5500/N (modificati con frizioni OMG)	<b>Art. Kit 15871</b>    	OEM ER135120 Kit Frizione con spingidisco, reggispinta frizione, cuscinetto guida frizione, kit bulloni e disco frizione		
5300 - 5310 - 5400 - 5410 - 5500 - 5510	<b>Art. 15872</b>  OEM AL 120 117 Meccanismo frizione a 6 leve Ø 280 mm con disco a 6 pale 34x40 mm - Z.12	<b>Art. 15873</b>  OEM AL 120 118 Disco avanzamento sint. Ø 280 mm 22x19 mm - Z.13	<b>Art. 62597</b>  OEM JD33004  Cuscinetto 45x75x16 mm	
		<b>Art. 62580</b>  OEM  Cuscinetto 17x40x12 mm	<b>Art. 15900</b>  OEM A246129 Collare con cuscinetto	
840-940-1020-1040-1140-1530-1630	<b>Art. Kit 16192</b>    	OEM Kit composto da: - Meccanismo 15884 - Disco PTO 15885 - Cuscinetti 15744 - 63863		
	<b>Art. Kit 16193</b>    	OEM Kit composto da: - Meccanismo 15884 - Disco PTO 16012 - Cuscinetti 15936 - 63863		
	<b>Art. 15884</b>  OEM AL120023 AL39618 Meccanismo monodisco Z.23 Ø 280 mm	<b>Art. 15885</b>  OEM AL120017 AL67525 Disco PTO Ø 280 22x26 mm - Z.15	<b>Art. 15744</b>  OEM Cuscinetto reggispinta cambio 55x90x20 mm	
	<b>Art. 15936</b>  OEM Cuscinetto 58x96x57 mm	<b>Art. 16012</b>  OEM AL120018 Disco con molle parastrappi Ø 280 mm - Z.15	<b>Art. 62577</b>  OEM Cuscinetto VOLANO 15x35x11 mm	
820-830-840 - 920-930-940-V - 1030-1030VU-1035-1040-V - 1130-1140-F-1350 - 1530-1550-1630-VU-1635-EF-EV - 1640-F-1750-V-1840-F-1850-F-N-V - 1950-N-2020-2030-3040-2120-2150-2155 - 2250-F-2350-2450-F	<b>Art. Kit 15935</b>  	OEM Kit Frizione con meccanismo doppio e disco frizione		
	<b>Art. 15885</b>  OEM AL120017 AL67525 Disco PTO Ø 280 mm 22x26 mm - Z.15	<b>Art. 15744</b>  OEM Cuscinetto reggispinta cambio 55x90x20 mm	<b>Art. 62577</b>  OEM Cuscinetto VOLANO 15x35x11 mm	



# Frizioni e loro componenti

CLUTCHES - CLUTCH DISK - BEARING - COUPLING - LEVER - SET-REVISION

## segue JOHN DEERE





















2130 - 3030	<b>Art. 15886</b>  OEM AL120024 AL23095 Meccanismo monodisco Z.23 Ø 320 mm	<b>Art. 15887</b>  OEM AL120016 AL30451 Disco PTO Ø 300 mm 22x26 mm - Z.15	
	<b>Art. 15888</b>  OEM AL120025 AL28039 Meccanismo monodisco Z.27 Ø 320 mm	<b>Art. 15889</b>  OEM AL120015 AL30452 Disco PTO Ø 300 mm 26x32 mm - Z.10	
1640 - 2040 - 2140 - 2240	<b>Art. Kit 16194</b>  new	   	OEM Kit composto da: - Meccanismo 15890 - Disco PTO 15893 - Cuscinetti 15936 - 63863
(segue JOHN DEERE)	<b>Art. 15890</b>  OEM AL120026 AL39592 Meccanismo monodisco Z.23 Ø 320 mm	<b>Art. 15893</b>  OEM AL120011 AL64340 Disco PTO Ø 320 mm 22x26 mm - Z.15	<b>Art. 15937</b>  OEM AL120013 Disco PTO Ø 295 mm 22x26 mm - Z.15
	<b>Art. 16150</b>  new OEM AL120029 Reggispinta idraulico	<b>Art. 15936</b>  OEM Cuscinetto 58x96x57	<b>Art. 62577</b>  OEM Cuscinetto volano 15x35x11 mm <b>Art. FAG 63863</b>

# Frizioni e loro componenti











CLUTCHES - CLUTCH DISK - BEARING - COUPLING - LEVER - SET-REVISION

11

## segue JOHN DEERE

2251/N - 2351 - 2651 - 2951 - 3640 - 3650	<b>Art. 15897</b>  LUK	OEM AL68486 Meccanismo monodisco Ø 330 mm	<b>Art. 15898</b>  LUK	OEM AL68023 Disco avanzamento metalceramico a 6 pale Ø 330 mm - Z.10	
5215-5215F-5215V 5315-5315F-5315V	<b>Art. Kit 15955</b>  LUK	 LUK	 LUK	OEM <b>Kit Frizione bidisco</b> con meccanismo a 6 leve e disco PTO Ø 280 mm. 34x40 mm - Z.12	
	<b>Art. 15873</b>  LUK	OEM AL12018 Disco frizione rigido sinterizzato a 4 pale mozzo 22x19 mm - Z.13	<b>Art. 63363</b>  OEM	OEM Cuscinetto PTO 100x65x18 mm	<b>Art. 62580</b> OEM  Cuscinetto 17x40x12 mm <b>Art. FAG 63866</b>
5075GF/GN/GV - 5080G/GF/GV - 5085GF/GN/GV - 5090G/GF/GH/GV - 5100GF/GV - 5415 - 5515/F/HC/V - 5615/F/V	<b>Art. Kit 15957</b>  LUK	 LUK	 LUK	 LUK	 LUK
	<b>Art. Kit 16105</b>  LUK	 LUK	 LUK		OEM ER200707  Kit composto da: - Meccanismo - Disco frizione 15873 - Cuscinetto 63895
	<b>Art. 15958</b>  LUK	OEM Frizione bidisco a 6 leve Ø 280 mm con disco a 6 pale 34x40 mm - Z.12	<b>Art. 15873</b>  LUK	OEM AL12018 Disco frizione rigido sinterizzato a 4 pale mozzo 22x19 mm - Z.13	<b>Art. 63363</b> OEM  Cuscinetto PTO 100x65x18 mm <b>Art. FAG 63895</b>
5200 - 5300 - 5400/N - 5500/N- 5600 - 5700 - 5210 - 5310/N - 5410 - 5510/N - 5415/H - 5615/HC - 5715/H/HC	<b>Art. 16121</b> (frizione OMG) 			OEM 351480 - RE66695 Kit Frizione a 6 leve Ø 280 completo di: disco AVANZAMENTO sinterizzato a 5 pale Ø 280 mm Z.19 - 32x35 disco PTO rigido Ø 280 mm Z.13 - 22x25	































## KUBOTA

Serie M 4050 - 7050 4000ER 4850 5000ER 5030 - 5850 6000ER 6030 7000ER 7030 - 7500 8000ER 8030 M 4030/SU M4500 M4950 M5500	<b>Art. Kit 16083</b>  LUK	 LUK	 LUK	 LUK	 LUK	 LUK	OEM 3567225101  Kit composto da: - Meccanismo 15878 - Disco 15879 - Cuscinetti 15990 - 63866
	<b>Art. 15878</b>  LUK	OEM 35672 - 25101 Disco interno D.280 35x40 mm - Z.14	<b>Art. 15879</b>  LUK	OEM 35653 - 25143 Disco D.280 20x24 mm - Z.10			
	<b>Art. 15280</b> 	OEM Cuscinetto reggispinta cambio 90x50x22 mm	<b>Art. 15990</b>  LUK	OEM Cuscinetto reggispinta cambio 90x50x22 mm	<b>Art. 62580</b> OEM  Cuscinetto 17x40x12 mm <b>Art. FAG 63866</b>		

# Frizioni e loro componenti

CLUTCHES - CLUTCH DISK - BEARING - COUPLING - LEVER - SET-REVISION

## LAMBORGHINI RUOTE

R360 - R360 DT - R365 - R365 DT - R470 - R470 DT - R475 - R475 DT	<b>Art. 15182</b>  OEM 404 0044 1 Disco frizione centrale rigido in ferodo 295x170x3,85 mm 48x44EV - Z.23	<b>Art. 15411</b>  OEM 427 2450 3 Disco PTO rigido in ferodo 280 x165x3,5 mm 30x27EV - Z.16	
R483 - R483 DT CRONO 554-60	<b>Art. Kit 16044</b>      	OEM 0.012.2564.4  Kit composto da: - Meccanismo 15395 - Disco PTO 15804 - Cuscinetti 15990 - 63896 - 63836	
	<b>Art. 15395</b>  OEM 463.2411.4 0.012.2564.4 - Meccanismo a 6 leve completo di disco centrale in ferodo senza il disco PTO - Piatto Ø 250 mm (11")	<b>Art. 15804</b>  OEM 0.011.9063.3 Disco PTO rigido in ferodo 225x145x3,5 mm 25x22EV - Z.14	<b>Art. 15990</b>  OEM 2.2999.153.0/10 Cuscinetto reggispinta cambio 90x50x22 mm
	<b>Art. 15402</b>  OEM 254.2213.3 463.2413.3 - 0.012.2565.3 Disco centrale rigido in ferodo 250x155x3,5 mm 40x36EV - Z.20	<b>Art. 15403</b>  OEM 254.2222.3/10 463.2422.3 Disco PTO rigido in ferodo 250x155x3,5 mm 25x22EV - Z.14 <b>Per vecchi modelli</b>	<b>Art. 15280</b>  OEM 2.2999.153.0/10 Cuscinetto reggispinta cambio 90x50x22 mm
		<b>Art. 62951</b>  OEM 2.2021.018.0 Cuscinetto reggispinta PTO 70x110x20 mm <b>Art. FAG 63896</b>	<b>Art. 62549</b>  OEM Cuscinetto PTO 20x47x14 mm <b>Art. FAG 63836</b>
R503 - R503 DT - R583 - R583 DT - R633 - R633 DT - R683 - R683 DT - R653 - R653 DT - R654 - R654 DT - R684 - R684 DT - R724 - R724 DT - R754 - R754 DT - R824 - R824 DT - R845 - R845 DT - R854 - R854 DT	<b>Art. Kit 15959</b>      	OEM  Kit composto da: - Meccanismo 15745 - Disco 15917 - Cuscinetti 15990 - 63896 - 63836	
	<b>Art. 15745</b>  OEM 0.012.2574.4 -0.012.2571.4 Meccanismo 6 leve completo di disco centrale sinterizzato 40x36 - Z.20 Piatto Ø 280 mm	<b>Art. 15917</b>  OEM 0.011.9067.3 Disco Ø 280 mm 22x25 mm - 14 cave	<b>Art. 15119</b>  OEM 171.2272.3 - 463.2413.3 - 171.2251.3 Disco centrale metalceramico rigido a 6 placchette Ø 280 mm sinterizzato 40x36EV - Z.20
	<b>Art. 15397</b>  OEM 422.2261.3 - 463.2413.3 Disco centrale rigido in ferodo 280x165x3,8 mm 40x36EV - Z.20	<b>Art. 15280</b>  OEM 2.2999.153/10 Cuscinetto reggispinta cambio 90x50x22 mm	<b>Art. 62951</b>  OEM 2.2021.018.0 Cuscinetto reggispinta PTO 70x110x20 mm <b>Art. FAG 63896</b>
	<b>Art. 15990</b>  OEM 2.2999.153.0/10 Cuscinetto reggispinta cambio 90x50x22 mm	<b>Art. 15404</b>  OEM 2.2099.008.0 Cuscinetto reggispinta 95x50x21,5 mm	<b>Art. 62549</b>  OEM Cuscinetto PTO 20x47x14 mm <b>Art. FAG 63836</b>



























(segue  
LAMBORGHINI  
RUOTE)

# Frizioni e loro componenti

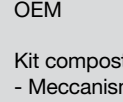
CLUTCHES - CLUTCH DISK - BEARING - COUPLING - LEVER - SET-REVISION

11

## segue LAMBORGHINI RUOTE































R704 - R704 DT R804 - R804 DT	<b>Art. 15540</b>  OEM 427.2410.4/10 - Meccanismo a 6 leve completo di disco centrale metalceramico a 6 pale - senza il disco PTO. - Piatto Ø 280 mm (11")	<b>Art. 15541</b>  OEM 427.2451.3 Disco centrale metalceramico rigido a 6 pale Ø 280 mm sinterizzato 48x44EV - Z.23	<b>Art. 15121</b>  OEM 422.2222.3/20 Disco PTO rigido in ferodo 280x165x3,5 mm 25x22EV - Z.14 N.B.: Solo per mod. R804 - R804DT
		<b>Art. 15542</b>  OEM 427.2450.3/10 Disco PTO rigido in ferodo 280x165x3,5 mm 30x27EV - Z.16 N.B.: Solo per mod. R704 - R704DT	
R955 - R955DT		<b>Art. 15392</b>  OEM 195.2250.3 Disco centrale metalceramico rigido a 6 placchette Ø 310 mm sinterizzato 40x36EV - Z.20	
R1106 - R1106 DT - R1156 - R1156 DT - R1256 - R1256 DT - R1306 TURBO DT - R1506 TURBO DT - R1706 TURBO DT -	<b>Art. Kit 15394</b>  <b>LUK</b>	<b>Art. 15410</b>  OEM 212.2358.4/10 KIT meccanismo presa di movimento con disco	<b>Art. 15293</b>  OEM 212.2359.3/10 Disco centrale metalceramico a 7 pale Rigido Ø 350 mm sinterizzato 50x45EV - Z.24
<b>Originale VALEO</b>	<b>Art. 15445</b>  OEM 269.2313.3 Disco presa di movimento rigido in ferodo 352x195x4,3 mm 50x45EV - Z.24	<b>Art. 15410</b>  OEM 250.6533.3 Manicotto con cuscinetto reggispinta	<b>Art. 15883</b>  OEM 2.2999.510.0 2.2999.207.0 2.2999.443.0 112x65x42 mm Cuscinetto reggispinta
FORMULA 105 AGILE 880S -990S CROSS 674-70N/ BASSO - GRAN PRIX 674-70 774-80 - 874-90T SPRINT 674-70 675-75 - 684-85	<b>Art. 15420</b>  OEM 0.014.9424.3 0.008.4293.3 0.008.4254.3/10 Meccanismo con molle a diaframma Piatto Ø 310 mm	<b>Art. 15982</b>  OEM 0.015.9289.3 0.014.111 1.3 Disco centrale metalceramico 6 pale Ø310 mm sinterizzato 41x36 mm - Z.24	<b>Art. 15895</b>  OEM 0.014.9433.3 Disco centrale metaceramico 6 pale con parastrappi Ø310 mm sinterizzato 41x36,5 mm - Z.24
		<b>Art. 15748</b>  OEM 0.015.9289.3 0.014.1111.3 Disco centrale metaceramico 6 pale con parastrappi Ø310 mm sinterizzato 40x36,5 mm - Z.24	<b>Art. 15744</b>  OEM 2.2999.475.0 Cuscinetto reggispinta cambio 90x55x22 mm
CRONO 564.60 574.70 GRIMPER 555-560 PLUS 880F-990F	<b>Art. Kit 15959</b>  <b>LUK</b>	    	OEM Kit composto da: - Meccanismo 15745 - Disco 15917 - Cuscinetti 15990 - 63836 - 63896
	<b>Art. 15745</b>  OEM 0.012.2574.4 - 0.012.2571.4 Meccanismo 6 leve completo di disco centrale sinterizzato 40x36 - Z.20 Piatto Ø 280 mm	<b>Art. 15917</b>  OEM 0.011.9067.3 Disco Ø 280 mm 22x25 mm - 14 cave	<b>Art. 62951</b>  OEM 2.2021.018.0 Cuscinetto reggispinta PTO 70x110x20 mm
	<b>Art. 15990</b>  OEM 2.2999.153.0/10 Cuscinetto reggispinta cambio 90x50x22 mm	<b>Art. 15280</b>  OEM 2.2999.153/10 Cuscinetto reggispinta cambio 90x50x22 mm	<b>Art. 62549</b>  OEM Cuscinetto PTO 20x47x14 mm
(segue LAMBORGHINI RUOTE)			<b>Art. FAG 63836</b>



# Frizioni e loro componenti

CLUTCHES - CLUTCH DISK - BEARING - COUPLING - LEVER - SET-REVISION

## segue LAMBORGHINI RUOTE



























AGILE 880S-990S CROSS 674-70N GRAN PRIX 674-70/774-80-874-90T	<b>Art. 15746</b>  LUK	OEM 0.015.9285.3 0.008.4254.3/10 Meccanismo con molla a diaframma piatto Ø 310 mm	<b>Art. 15963</b>  LUK	OEM 44623.303 0.455.2330.3/10 0.015.9288.3 Disco centrale in ferodo con molle parastrappi 310x191x3,5 mm 40x36,5 mm - Z.24	<b>Art. 15441</b>  LUK	OEM 44623.303 0.455.2330.3/10 0.015.9288.3 Disco centrale in ferodo con molle parastrappi 310x191x3,5 mm 40x36,5 mm - Z.24
	<b>Art. 16011</b>  LUK	OEM 0.015.6393.3 Disco centrale in ferodo Ø 310 mm - Z.24	<b>Art. 15962</b>  LUK	OEM 0.015.9289.3 0.014.1111.3 Disco centrale metaceramico 6 pale con parastrappi Ø 310 mm sinterizzato 41x36 mm - Z.24	<b>Art. 15748</b>  LUK	OEM 0.015.9289.3 0.014.1111.3 Disco centrale metaceramico 6 pale con parastrappi Ø 310 mm sinterizzato 40x36,5 mm - Z.24
					<b>Art. 15744</b>  LUK	OEM 2.2999.475.0 Cuscinetto reggispinta cambio 90x55x22 mm
AGILE 660S 770S CROSS 574-60N 674-70N/BASSO GRAN PRIX 674-70 SPRINT 654-55 664-60 664-65	<b>Art. Kit 16038</b>  LUK	 LUK	 LUK	 LUK	OEM 0.015.9287.3 Kit composto da: - Meccanismo 15439 - Disco centrale 15979 - Cuscinetto 15744	
	<b>Art. 15439</b>  LUK	OEM 0.015.9287.3 255.2320.3/10 0.009.6914.3/20 Meccanismo con molle a diaframma Piatto Ø 280 mm	<b>Art. 15979</b>  LUK	OEM 0.015.9286.3 Disco frizione centrale in ferodo con molle parastrappi 280x172x3,5 mm 40x36,5EV - Z.24	<b>Art. 15440</b>  LUK	OEM 0.015.9286.3 0.009.6913.3/10 255.2330.3/20 270.2330.3/10 Disco frizione centrale in ferodo con molle parastrappi 280x172x3,5 40x36,5EV - Z.24
				<b>Art. 15744</b>  LUK	OEM 2.2999.475.0 Cuscinetto reggispinta 90x55x22 mm	
FORMULA 135 PREMIUM 1300	<b>Art. Kit 16042</b>  LUK	 LUK	 LUK	 LUK	OEM Kit composto da: - Meccanismo 15881 - Disco PTO 15882 - Cuscinetto 15883	
	<b>Art. Kit 16039</b>  LUK	 LUK	 LUK	OEM Kit composto da: - Meccanismo 15881 - Disco PTO 15882		
	<b>Art. 15881</b>  LUK	OEM 008.5595.3 Meccanismo frizione Ø 350	<b>Art. 15882</b>  LUK	OEM 008.5596.3 Disco PTO Ø 350 mm - 41x45 mm Z.21	<b>Art. 15883</b>  LUK	OEM 2.2999.510.0 2.2999.207.0 2.2999.443.0 112x65x42 mm Cuscinetto reggispinta
RUNNER 250-350-450	<b>Art. Kit 15987</b>  LUK	 LUK	 LUK	OEM 0.012.5851.4/20 Kit frizione doppia a 6 leve con disco interno Ø 230 mm		
			<b>Art. 62952</b>  LUK	OEM Cuscinetto reggispinta PTO 75x115x20 mm	<b>Art. 62577</b>  LUK	OEM Cuscinetto volano 15x35x11 mm
(segue LAMBORGHINI RUOTE)			<b>Art. FAG 63897</b>		<b>Art. FAG 63863</b>	

# Frizioni e loro componenti

CLUTCHES - CLUTCH DISK - BEARING - COUPLING - LEVER - SET-REVISION

11

## segue LAMBORGHINI RUOTE

FORMULA 105-115-135 GRAN PRIX 774-80 874-90T PREMIUM 850 950 1050 1060 1300 774 774.5 774.80 874 TURBO 874-90 GP	<b>Art. 15647</b> OEM 0.008.4184.3 0.014.9423.3 Meccanismo con molle a diaframma Piatto Ø 330 mm 	<b>Art. 15964</b> OEM 008.9937.3 Disco centrale in ferodo con molle parastrappi 330x196x4,2 mm 41x36,5EV - Z.24 	<b>Art. 15803</b> OEM 008.9937.3 Disco centrale in ferodo con molle parastrappi 330x196x4,2 mm 41x36,5EV - Z.24 	
	<b>Art. 15895</b> OEM 007.7928.3 Disco centrale metaceramico 6 pale con parastrappi Ø310 mm sinterizzato 41x36,5 mm - Z.24 Per 774 - 774.5 - 774.80 - 874 TURBO - 874-90 GP 	<b>Art. 15965</b> OEM 0.014.9432.3 Disco centrale metaceramico a 6 pale con molle parastrappi Ø330 mm sinterizzato 41x45,3 mm - Z.21 Per gli altri modelli 	<b>Art. 15749</b> OEM 0.014.9432.3 Disco centrale metaceramico a 6 pale con molle parastrappi Ø330 mm sinterizzato 41x45,3 mm - Z.21 Per gli altri modelli 	<b>Art. 15883</b> OEM 2.2999.510.0 2.2999.207.0 2.2999.443.0 112x65x42 mm Cuscinetto reggispinta 
	<b>Art. 15984</b> OEM 0.016.6105.3 Disco centrale metaceramico a 6 pale con molle parastrappi Ø 330 mm sinterizzato 41x36,5EV - Z.24 	<b>Art. 15673</b> OEM 009.6533.3 Disco centrale metaceramico a 6 pale con molle parastrappi Ø 330 mm sinterizzato 41x36,5EV - Z.24 	<b>Art. 15744</b> OEM 2.2999.475.0 Cuscinetto reggispinta 90x55x22 mm 	
573 573 60N 574 574 60 N 674 674-70 AGILE 660 AGILE 770	<b>Art. 15894</b> OEM 0.015.6392.4 255.2350.3 Meccanismo frizione con diaframma Ø 280 mm 	<b>Art. 15979</b> OEM 0.015.9286.3 Disco frizione centrale in ferodo con molle parastrappi 280x172x3,5 mm 40x36,5EV - Z.24 	<b>Art. 15440</b> OEM 0.015.9286.3 0.009.6913.3/10 255.2330.3/20 270.2330.3/10 Disco frizione centrale in ferodo con molle parastrappi 280x172x3,5 40x36,5EV - Z.24 	
R3.75 R3.85-T R3.95-T-TB C90-100 C95-105 TRIUMPH100	<b>Art. Kit 16041</b>    	OEM 0.012.2621.4  Kit composto da: - Meccanismo 15923 - Disco centrale 15924 - Cuscinetto 15744		
	<b>Art. 15923</b> OEM 0.012.7094 Meccanismo frizione con molle a diaframma Ø 330 mm (13") 	<b>Art. 15924</b> OEM 0.012.7095.3/10 Disco centrale a 5 pale 36,5x41 mm - Z.24 	<b>Art. 15744</b> OEM 2.2999.475.0 Cuscinetto reggispinta 90x55x22 mm 	
CRONO 564-60 - 554-55 - 564-65F R 660	<b>Art. 15916</b> OEM 0.012.2567.4 0.019.8634.4 Meccanismo a 6 leve completo di disco Ø 280 mm 	<b>Art. 15917</b> OEM 0.011.9067.3 Disco Ø 280 mm 22x25 mm - 14 cave 	<b>Art. 15990</b> OEM 2.2999.153.0/10 Cuscinetto reggispinta cambio 90x50x22 mm 	
			<b>Art. 15280</b> OEM 2.2999.153.0/10 Cuscinetto reggispinta cambio 90x50x22 mm 	
345	<b>Art. 15912</b> OEM 151.2222.3 0.015.6382.3 0.008.4803.3 Disco frizione rigido interno organico Ø 230 40x35 mm - Z.14 	<b>Art. 15913</b> OEM 151.2213.3 0.014.9429.3 0.008.4804.3 Disco lato cambio esterno Ø 250 mm 25x20x4 mm - Z.10 		

# Frizioni e loro componenti

CLUTCHES - CLUTCH DISK - BEARING - COUPLING - LEVER - SET-REVISION













## segue LAMBORGHINI RUOTE

FORMULA 115 - PREMIUM 850/950/1050/1100 - R774 80GP/80N R874 90GP	<b>Art. 15954</b>  OEM 0.010.6912.3/10 0.015.6386.3 Meccanismo con molle a diaframma Piatto Ø 350 mm	<b>Art. 15953</b>  OEM 0.007.7929.3/10 0.015.6328.3 Disco Ø 350 mm 36,5x41 mm - Z.24	<b>Art. 15983</b>  OEM 0.007.7930.3/10 Disco Ø 350 mm 41x45 mm - Z.21
		<b>Art. 16010</b>  OEM 0.015.6381.3 Disco Ø 330 mm 36,5x41 mm - Z.24	<b>Art. 15744</b>  OEM 2.2999.475.0 Cuscinetto reggispinta 90x55x22 mm
<b>new</b> CF 100 L/N - 90 L/N/ST CROSS 75/80/674-75N NITRO R 90 R2.70/76/80/86/90 R2.76/86 TARGET R3.75 T/TB R3.80/85/90 R3 EVO 85/85TARGET R3.90 TREND RF 70/75/90/100/110 RS 70/75/90/100/110 RV 80/90/100/110 SPIRE 70/80/85/90/ F80/F90/F100/F105/ F115/S80/S90/S100/ S105/S115/V80/V90/ V100/V105/V115 STRIKE 80/90/CF90/ CF100	<b>Art. Kit 16055</b>    	OEM Kit composto da: - Meccanismo 15960 - Disco 15961 - Cuscinetto 15744	
	<b>Art. 15960</b>  OEM 0.014.9017.3 Meccanismo frizione con molle a diaframma Ø 310 mm	<b>Art. 15961</b>  OEM 0.014.9016.3 0.015.2816.3 Disco Ø 310 mm	<b>Art. 15744</b>  OEM 2.2999.475.0 Cuscinetto reggispinta 90x55x22 mm
<b>new</b> CRONO 65/70/75/ CROSS 65S/50R/55R /60R REKORD 60/70/60E/ 70E/65/75 TREND 65/70/75 SPIRE TREND 50/65/70/75/F70	<b>Art. Kit 16218</b>      	OEM 9.J1424.00.9 - 0.015.4708.3/10 Kit Frizione con meccanismo a 6 leve disco e cuscinetti. Piatto Ø 280 mm.	









# Frizioni e loro componenti

CLUTCHES - CLUTCH DISK - BEARING - COUPLING - LEVER - SET-REVISION

## LAMBORGHINI CINGOLI

C230 - C340 - C352 - C362 -	<b>Art. 15417</b>  OEM 434.5714.0/10 Anello frizione di sterzo - dentatura esterna 219,2x152x4,7 mm 71 denti	<b>Art. 15672</b>  OEM 431.2313.3 Disco centrale rigido in ferodo-tessuto 225x145x3,5 mm 25,5x20,5x4 mm - Z.10 Per frizione singola	
C350 - C452	<b>Art. 15180</b>  OEM 400.2401.4 Disco frizione centrale rigido in ferodo tessuto 250x150x3,5 mm 45x41EV - Z.16	<b>Art. 15355</b>  OEM 400.2401.5 Disco PTO rigido in ferodo 250x150x3,5 mm 28x23x6 mm - Z.6	<b>Art. 15181</b>  OEM 0.400.1808.7 Disco PTO rigido in ferodo 250x150x3,5 mm 22x18x6 mm - Z.6
	<b>Art. 15206</b>  OEM 400.0515.4 Anello frizione di sterzo - dentatura esterna 219,2x152x6 mm 71 denti		
C482L - C503 - C553 - C583 - C663 - C664 - ERGMATIC	<b>Art. 15397</b>  OEM 422.2261.3 Disco frizione centrale rigido in ferodo tessuto 280x165x3,8 mm 40x36EV - Z.20	<b>Art. 15121</b>  OEM 84751.3/10 - 422.2222.3/20 Disco PTO rigido in ferodo 280x165x3,5 mm 25x22EV - Z.14	<b>Art. 15389</b>  OEM 160.5715.0 Anello per frizione di sterzo - dentatura interna 229x171x2 mm 21 denti
	<b>Art. 15176</b>  OEM 160.5714.0/10 Anello per frizione di sterzo - in tessuto - dentatura esterna 239x180x4,8 - 28 denti	<b>Art. 15174</b>  OEM 160.5714.0/10 Anello per frizione di sterzo - in conglomerato - dentatura esterna 239x180x4,8 - 28 denti	
C503 (2ª serie tutte le versioni) C553-C603 (tutte le versioni) C653 (2ª serie tutte le versioni) C754	<b>Art. 15177</b>  OEM 160.2214.0 Anello per frizione centrale - dentatura esterna 277x166x7 - 45 denti		

## LAMPACRESCIA - MGM

MOTAZAPPA MOTOCOLTIVATORE (motore benzina)	<b>Art. 15845</b>  OEM Frizione Ø 103x99 mm a 3 dischi 12x15EV - Z.8 Albero Ø 23 mm	<b>Art. 15630</b>  OEM Disco frizione sinterizzato Ø 93 mm	
MOTAZAPPA MOTOCOLTIVATORE (motore diesel)	<b>Art. 15589</b>  OEM Frizione Ø 103x99 mm a 4 dischi 15x12EV - Z.8 Albero Ø 23 mm	<b>Art. 15630</b>  OEM Disco frizione sinterizzato Ø 93 mm	
MOTAZAPPA MOTOCOLTIVATORE (motore HONDA)	<b>Art. 15847</b>  OEM Frizione Ø 103x128 mm a 4 dischi 12x15EV - Z.8 Albero Ø 19,05 mm	<b>Art. 15630</b>  OEM Disco frizione sinterizzato Ø 93 mm	
MOTAZAPPA MOTOCOLTIVATORE (motore HONDA)	<b>Art. 15848</b>  OEM Frizione Ø 103x139 mm a 3 dischi 12x15EV - Z.8 Albero Ø 25,4 mm	<b>Art. 15630</b>  OEM Disco frizione sinterizzato Ø 93 mm	































# Frizioni e loro componenti

CLUTCHES - CLUTCH DISK - BEARING - COUPLING - LEVER - SET-REVISION

11

## LANDINI RUOTE



































5500-5550-5830-6500 6880-6030-6830-5840 6040-6840-5860-6060 6860-6550. BLIZZARD 50-55-60-65. ATLAS 70-75. FRUTTETI 5530-6030-6530-5560 6060-6560. ADVANTAGE 55-65. SERIE REX	 <p><b>Art. 15574</b></p>	<p>OEM 3303238M93 3303000M96 - 3540479M91 - Meccanismo a 6 leve completo di disco centrale molleggiato in ferodo - fornito senza disco PTO - Piatto Ø 280 mm (11")</p>	 <p><b>Art. 15972</b></p>	<p>OEM 1424135M94 Disco PTO rigido in ferodo 280x165x3 mm 25x22EV Z.10</p>	 <p><b>Art. 15642</b></p>	<p>OEM 1424135M93 Disco PTO rigido in ferodo 280x165x3 mm 25x22EV Z.10</p>
	 <p><b>Art. 15147</b></p>	<p>OEM 3311538M92 Disco centrale in ferodo con molle parastrappi 280x165x4,4 mm 40x35EV - Z.14</p>	 <p><b>Art. 15990</b></p>	<p>OEM 1423473M94 Cuscinetto reggispinta cambio 90x50x22 mm</p>	 <p><b>Art. 15280</b></p>	<p>OEM 1423473M94 Cuscinetto reggispinta cambio 90x50x22 mm</p>
	 <p><b>Art. 15404</b></p>	<p>OEM 392051X1 Cuscinetto reggispinta 95x50x21,5 mm</p>	 <p><b>Art. 15751</b></p>	<p>OEM 1442381X1 Cuscinetto reggispinta PTO 65x100x11 mm</p>	 <p><b>Art. 62583</b></p>	<p>OEM 339599X1 - 3670612M1 Cuscinetto volano 20x47x14 mm</p>
					 <p><b>Art. FAG 63869</b></p>	
ADVANTAGE 55F/FB/ GE/GT - 60F/FP/GE/ GT/GTP/L/LP/V - 75F/ FP/GE/GT/GTP/L/ LP/V - 85F/FP/GE/GT/ GTP/L/LP/V BLIZZARD 75-85 REX 80F SERIE 254-274-284- 364-374-394 4530-4830-4830-5500- 5530-5550-5830-5840- 5860-6030-6040-6060- 6500-6530-6550-6560- 6830-6840-7500-7530- 7550-7830-7860-7870- 7880-8500-8530-8550- 8830-8860-8870	 <p><b>Art. Kit 16037</b></p>	    			<p>OEM</p> <p>Kit composto da: - Meccanismo 15575 - Disco PTO 15972 - Cuscinetti 15990 - 15751 - 63869</p>	
	 <p><b>Art. Kit 15928</b></p>	 	<p>OEM 3532239M93</p> <p>Kit composto da: - Meccanismo 15575 - Disco PTO 15972</p>			
N.B.: VALEO e LUK sono intercambiabili fra di loro	 <p><b>Art. 15575</b></p>	<p>OEM 3304583M95 3540480M91 - Meccanismo a 6 leve completo di disco centrale metalceramico a 5 pale - fornito senza disco PTO - Piatto Ø280 mm (11")</p>	 <p><b>Art. 15972</b></p>	<p>OEM 1424135M94 Disco PTO rigido in ferodo 280x165x3 mm 25x22EV Z.10</p>	 <p><b>Art. 15642</b></p>	<p>OEM 1424135M94 Disco PTO rigido in ferodo 280x165x3 mm 25x22EV Z.10</p>
	 <p><b>Art. 15414</b></p>	<p>OEM 1424149M95 3304586M91 Disco centrale metalceramico con molle parastrappi a 5 pale Ø 280 sinterizzato 40x35EV - Z.14</p>	 <p><b>Art. 15280</b></p>	<p>OEM 1423473M94 Cuscinetto reggispinta cambio 90x50x22 mm</p>	 <p><b>Art. 15990</b></p>	<p>OEM 1423473M94 Cuscinetto reggispinta cambio 90x50x22 mm</p>
	 <p><b>Art. 15751</b></p>	<p>OEM 1442381X1 Cuscinetto reggispinta PTO 65x100x11 mm</p>	 <p><b>Art. 15404</b></p>	<p>OEM 392051X1 Cuscinetto reggispinta 95x50x21,5 mm</p>	 <p><b>Art. 62583</b></p>	<p>OEM 339599X1 - 3670612M1 Cuscinetto volano 20x47x14 mm</p>
				 <p><b>Art. FAG 63869</b></p>		

(segue LANDINI  
RUOTE)

# Frizioni e loro componenti

CLUTCHES - CLUTCH DISK - BEARING - COUPLING - LEVER - SET-REVISION

## segue LANDINI RUOTE

6850-6860-6870-6880-7860-7870-7880-8860-8870-8880-9060-9080-9880/H BLIZZARD 65-75-85-95 ADVANTAGE 65-75-85-95 ATLAS 70-75-80-90-100 GHIBLI 80-90-100 REX 70F/L/GT-80F/L/GT-90F/GT-100GT SERIE 65F/GT/L-75F/GT/L/V-85F/GT/L/V VIEWMASTER 6880-7880-8880	<b>Art. Kit 15931</b>   	OEM 6521049M91  Kit composto da: - Meccanismo 15576 - Disco PTO 15974		
	<b>Art. Kit 16068</b>      	OEM 6625200A1  Kit composto da: - Meccanismo 15576 - Disco PTO 15974 - Cuscinetti 15404 - 15751 - 63869		
	<b>Art. 15576</b>  OEM 3532192M96 3540478M91 - Meccanismo a 6 leve completo di disco centrale metalceramico a 8 pale - senza il disco PTO - Piatto Ø 310 mm (12")	<b>Art. 15974</b>  OEM 3105233M92 3311943M91 Disco PTO rigido in ferodo 25x22EV 310x175x3,5 (12")-Z.10	<b>Art. 15578</b>  OEM 3105233M92 3311943M91 Disco PTO rigido in ferodo 25x22EV 310x175x3,5 (12") - Z.10	
	<b>Art. 15577</b>  OEM 3311942M91 Disco centrale metalceramico con molle parastrappi 8 pale Ø 310 sinterizzato (12") 40x35EV - Z.14	<b>Art. 15751</b>  OEM 1442381X1 Cuscinetto reggispinta PTO 65x100x11	<b>Art. 15404</b>  OEM 392051X1 Cuscinetto reggispinta 95x50x21,5 mm	<b>Art. 62583</b>  OEM 339599X1 - 3670612M1 Cuscinetto volano 20x47x14 mm  <b>Art. FAG 63869</b>
9500 - 9500 SPECIAL  Originale VALEO	<b>Art. Kit 15663</b>    	OEM 44017803 1823150M91 - Meccanismo a 6 leve completo di disco centrale metalceramico - con disco PTO e cuscinetto reggispinta - Piatto Ø 310 mm (12")		
	<b>Art. 15416</b>  OEM 1423267M91 Disco centrale metalceramico con molle parastrappi Ø 310 mm sinterizzato 45x40EV - Z.16	<b>Art. 15415</b>  OEM 1423269M91 Disco PTO rigido in ferodo 310x175x3,5 mm 29,5x23EV - Z.13		
10000 VECCHIA SERIE	<b>Art. Kit 16071</b>      	OEM 3541015M92 - 3302447M91 - 3302477M92  Kit composto da: - Meccanismo 15579 - Disco PTO 15419 - Cuscinetti 15864 - 15752 - 63872		
	<b>Art. 15579</b>  OEM 3301229M91 3304468M92 - Meccanismo a 6 leve completo di disco centrale metalceramico - senza il disco PTO - Piatto Ø 310 mm (12")	<b>Art. 15419</b>  OEM 3310234M91 3135367M91 Disco PTO rigido in ferodo 310x175x3,5 mm 30x27EV - Z.16	<b>Art. 15418</b>  OEM 3310761M91 Disco centrale metalceramico rigido Ø 310 mm sinterizzato 48x44EV - Z.23	
	<b>Art. 15864</b>  OEM Cuscinetto reggispinta 55x92x22 mm (tolleranza 8mm)	<b>Art. 15752</b>  OEM 392191X1 Cuscinetto reggispinta PTO - 75x115x13 mm	<b>Art. 62586</b>  OEM 392168X1 Cuscinetto volano 25x52x15 mm  <b>Art. FAG 63872</b>	



























(segue LANDINI RUOTE)

# Frizioni e loro componenti

CLUTCHES - CLUTCH DISK - BEARING - COUPLING - LEVER - SET-REVISION

11













































## segue LANDINI RUOTE

10000 S 12500 - 13000 14500	<b>Art. Kit 15933</b>   	OEM 3303137M94  Kit composto da: - Meccanismo 15580 - Disco PTO 15973		
	<b>Art. 15580</b>  	OEM 3303137M95 3540481M91 -1426390M94 - Meccanismo a 6 leve completo di disco centrale metalceramico a 8 pale - senza il disco PTO - Piatto Ø 330 mm - 13"	<b>Art. 15973</b>  	OEM 1426390M93 Disco PTO rigido in ferodo 327x175x3,8 mm 30x27EV - Z.16
	<b>Art. 15421</b> 	OEM 1426389M91 3302049M93 Disco centrale metalceramico rigido a 8 pale Ø 327 mm sinterizzato 48x44EV - Z.23	<b>Art. 15752</b> 	OEM 392191X1 Cuscinetto reggispinta PTO 75x115x13 mm
			<b>Art. 15422</b> 	OEM 1426390M93 Disco PTO rigido in ferodo 327x175x3,8 mm 30x27EV - Z.16
			<b>Art. 15742</b> 	OEM 3302143M91 Cuscinetto reggispinta cambio - 97x55x30mm
			<b>Art. 62586</b> 	OEM 392168X1 Cuscinetto volano 25x52x15 mm
			<b>Art. FAG 63872</b> 	
GLOBUS 50-60-70 TOP	<b>Art. Kit 15726</b>   	OEM 3553260M92 Frizione semplice con disco avanzamento in organico - Piatto Ø 280 mm		
	<b>Art. 15908</b>  	OEM 3540866M92 Disco frizione Ø 280 31x35 mm - Z.18		
LEGEND TOP 105-115-130-145-165	<b>Art. Kit 15729</b>   	OEM 3542226M91 Frizione semplice con disco avanzamento sinterizzato - Piatto Ø 350 mm		
	<b>Art. 15909</b>  	OEM 3540443M91 Disco frizione Ø 350 48x52 mm - Z.24	<b>Art. 16144</b> 	OEM 3664102M91 Cuscinetto 65x112x45 mm  <b>new</b>
MISTRAL 55 MISTRAL 60  (segue LANDINI RUOTE)	<b>Art. Kit 16203</b>   	OEM 6510439M91  Kit composto da: - Meccanismo - Disco PTO 15907		

# Frizioni e loro componenti

CLUTCHES - CLUTCH DISK - BEARING - COUPLING - LEVER - SET-REVISION

## segue LANDINI RUOTE

<p>LEGEND TECHNO 105-115-130-145-165</p>	<p><b>Art. Kit 15730</b>   </p>		<p>OEM 3549179M91 - 3559804M91 Frizione doppia con disco avanzamento e PTO sinterizzati - Piatto Ø 350 mm</p>
	<p><b>Art. 15909</b>  </p> <p>OEM 3540443M91 Disco frizione Ø 350 48x52 mm - Z.24</p>	<p><b>Art. 15910</b>  </p> <p>OEM 3541380M91 Disco frizione Ø 350 27x30 mm - Z.16</p>	<p><b>Art. 62586</b>  OEM 392168X1 Cuscinetto volano 25x52x15 mm</p> <p><b>Art. FAG 63872</b></p>
	<p><b>Art. 16125</b>  </p> <p>OEM 3549201M91 Cuscinetto reggispinta 60x96x28 mm</p> <p><b>new</b></p>	<p><b>Art. 16145</b>  </p> <p>OEM 3539704M91 Cuscinetto 105x130x12,75 mm</p> <p><b>new</b></p>	
<p><b>new</b> LANDPOWER 125 -165 - 185 LEGEND TOP 105-115 -120-130-140-145-165-180-185</p>	<p><b>Art. Kit 16142</b>    </p>		<p>OEM Frizione monodisco completa Ø 350 mm - Disco Ø 350 Z.24 a 8 pale con molle parastrappi - cuscinetto 60x97x26 mm</p>
<p>MISTRAL 40 - 45 - 50</p>	<p><b>Art. Kit 15899</b>   </p>	<p>OEM 4202165M91 Kit composto da: - Meccanismo - Disco PTO 15906</p>	
	<p><b>Art. 15906</b>  </p> <p>OEM 4202163M91 Disco frizione interno 27x30 mm - Z.16</p>	<p><b>Art. 15907</b>  </p> <p>OEM 4202164JA Disco PTO 14x17 mm - Z.9</p>	<p><b>Art. 63363</b>  OEM Cuscinetto PTO 100x65x18 mm</p> <p><b>Art. FAG 63895</b></p>
	<p><b>Art. 15990</b>  </p> <p>OEM 1423473M94 Cuscinetto reggispinta cambio 90x50x22 mm</p>	<p><b>Art. 15280</b>  </p> <p>OEM 1423473M94 Cuscinetto reggispinta cambio 90x50x22 mm</p>	<p><b>Art. 62577</b>  OEM Cuscinetto volano 15x35x11 mm</p> <p><b>Art. FAG 63863</b></p>
<p>MYTHOS 90/100 - 110/115</p>	<p><b>Art. Kit 15914</b>   </p>	<p>OEM 3559828M91 3657986M91 Meccanismo singolo con disco PTO Ø 330 mm</p>	
	<p><b>Art. 15915</b>  </p> <p>OEM 3657987M91 Disco PTO sinterizzato a 5 pale Ø 330 mm 48x44 mm - Z.23</p>	<p><b>Art. 16125</b>  </p> <p>OEM 3549201M91 Cuscinetto reggispinta 60x96x28 mm</p> <p><b>new</b></p>	
<p>17550 19000</p>	<p><b>Art. Kit 15904</b>   </p>	<p>OEM 3580944M92 - 3713264M91 Meccanismo bi-disco Ø 310 mm</p>	
<p>ALPINE 60-65-70-75-80-85 GLOBUS 75-80TOP</p>	<p><b>Art. Kit 15949</b>   </p>	<p>OEM 3654598M91 - 3648842M91 Kit meccanismo con disco Ø 310 mm</p>	
<p>(segue LANDINI RUOTE)</p>		<p><b>Art. 15950</b>  </p> <p>OEM 3654599M91 Disco a 6 pale Ø 310 mm 31x35 mm - Z.18</p>	

















# Frizioni e loro componenti











CLUTCHES - CLUTCH DISK - BEARING - COUPLING - LEVER - SET-REVISION

11

## segue LANDINI RUOTE

VISION 100/105/80/85/90/95 Serie 5h 80/90/100/110/115 POWERMONDIAL 105/100 - 105 REX 85/95/105	<b>Art. Kit 16094</b> 	 	 	OEM - 3657986M91 - 3667112M91 Kit frizione con disco avanzamento 5 pale Ø 330 mm Z.14
TECHNOFARM 75/80/85	<b>Art. Kit 16095</b> 	 	 	OEM 3696565M91 - 3692006M92 Kit frizione con disco PTO rigido Ø 310 mm Z.13
	<b>Art. 63363</b>  <b>Art. FAG 63895</b>	OEM 3695992M1 Cuscinetto PTO 100x65x18 mm	<b>Art. 62597</b>  <b>Art. FAG 63883</b>	OEM 369200M91 Cuscinetto PDF 45x75x16 mm
5-090D 5-100D 5-110D	<b>Art. Kit 16160</b> 	 	 	OEM 4218588M93 Kit frizione Ø 310 mm a 6 leve con disco PTO Ø 280 mm a 4 pale Z.10

























## LANDINI CINGOLI

C3200 EXPORT - CS3200 EXPORT - CL3200 SPECIAL - C4000 C-CL 4000 SPECIAL	<b>Art. 15206</b> 	OEM 973372M1 Anello per frizione di sterzo in ferodo - dentatura esterna 219,2x152x6 - 71 denti		
35 C 4000-4500-4830- 5000-5500-5530- 5830-5860-5870- 6030-6500 TL 21 3500	<b>Art. Kit 15940</b> 		<b>Art. 15234</b> 	OEM 1423838M91 1423980M91-1850838M91-3306277M91 Meccanismo monodisco Ø 250 mm a 3 leve con collare e disco PTO <b>Art. 62583</b>  OEM 339599X1 - 3670612M1 Cuscinetto volano 20x47x14 mm <b>Art. FAG 63869</b>
6500 CINGOLI 6830C	<b>Art. 15945</b> 	OEM 3306280M91 Meccanismo monodisco Ø 280 mm	<b>Art. 15169</b> 	OEM 3306282M1 Disco frizione rigido 279x171x4,3 mm 35x29x5,5 mm - Z.10
C6000 - CL600 - TL6C (segue LANDINI CINGOLI)	<b>Art. 15419</b>  	OEM 3310234M91 Disco PTO rigido in ferodo 310x175x3,5 mm 30x27EV - Z.16	<b>Art. 15423</b> 	<b>Art. 15389</b>  OEM 975743M1 Anello per frizione di sterzo - dentatura interna 229x171x2 - 21 denti

# Frizioni e loro componenti

CLUTCHES - CLUTCH DISK - BEARING - COUPLING - LEVER - SET-REVISION

## segue LANDINI CINGOLI

<p>C7800 - C7830 - TREKKER C75- C85-C95 DOPPIA FRIZIONE C4500-C5500-C6500- C4830-C5030-C5830- C6030-C6830. SERIE TREKKER</p> <p><b>N.B. VALEO e LUK sono intercambiabili fra di loro</b></p>	<p><b>Art. 15574</b>  OEM 3303238M93 3303000M96 - 3540479M91 - Meccanismo a 6 leve completo di disco centrale molleggiato in ferodo - fornito senza disco PTO - Piatto Ø 280 mm (11")</p>	<p><b>Art. 15972</b>  OEM 1424135M93 Disco PTO rigido in ferodo 280x165x3 mm 25x22EV Z.10</p>	<p><b>Art. 15642</b>  OEM 1424135M93 Disco PTO rigido in ferodo 280x165x3 mm 25x22EV Z.10</p>	
	<p><b>Art. 15147</b>  OEM 1424123M91 Disco centrale in ferodo con molle parastrappi 280x165x4,4 mm 40x35EV - Z.14</p>	<p><b>Art. 15404</b>  OEM 392051X1 Cuscinetto reggispinta 95x50x21,5 mm</p>	<p><b>Art. 15751</b>  OEM 1442381X1 Cuscinetto reggispinta PTO 65x100x11 mm</p>	
	<p><b>Art. 15990</b>  OEM 1423473M94 Cuscinetto reggispinta cambio 90x50x22 mm</p>	<p><b>Art. 15280</b>  OEM 1423473M94 Cuscinetto reggispinta cambio 90x50x22 mm</p>	<p><b>Art. 62583</b>  OEM 339599X1 - 3670612M1 Cuscinetto volano 20x47x14 mm <b>Art. FAG 63869</b></p>	
	<p><b>Art. 15178</b>  OEM 3300186M1 Anello per frizione di sterzo in ferodo - dentatura esterna 271x201x5 - 89 denti</p>	<p><b>Art. 15766</b>  OEM 3300184M1 Controdisco 260x190x2,5 mm 65 denti</p>	<p><b>Art. 15423</b>  OEM 1824733M1 Anello per frizione di sterzo in ferodo - dentatura esterna 239x180x5 mm - 28 denti</p>	
	<p><b>Art. Kit 15928</b>    OEM Kit composto da: - Meccanismo 15575 - Disco PTO 15972</p>			
	<p><b>Art. 15575</b>  OEM 3304583M95 3540480M91 - Meccanismo a 6 leve completo di disco centrale metalceramico a 5 pale - fornito senza disco PTO - Piatto Ø 280mm (11")</p>	<p><b>Art. 15972</b>  OEM 1424135M94 Disco PTO rigido in ferodo 280x165x3 mm 25x22EV Z.10</p>	<p><b>Art. 15642</b>  OEM 1424135M94 Disco PTO rigido in ferodo 280x165x3 mm 25x22EV Z.10</p>	
	<p><b>Art. 15414</b>  OEM 1424149M95 3306586M91 Disco centrale metalceramico con molle - parastrappi a 5 pale Ø 280 mm sinterizzato 40x35EV - Z.14</p>	<p><b>Art. 15990</b>  OEM 1423473M94 Cuscinetto reggispinta cambio 90x50x22 mm</p>	<p><b>Art. 15280</b>  OEM 1423473M94 Cuscinetto reggispinta cambio 90x50x22 mm</p>	
		<p><b>Art. 15751</b>  OEM 1442381X1 Cuscinetto reggispinta PTO 65x100x11 mm</p>	<p><b>Art. 62583</b>  OEM 339599X1 - 3670612M1 Cuscinetto volano 20x47x14 mm <b>Art. FAG 63869</b></p>	
	<p>C14000</p> <p>(segue LANDINI CINGOLI)</p>	<p><b>Art. 15423</b>  OEM 1824733M1 Anello per frizione di sterzo in ferodo - dentatura esterna 239x180x5 - 28 denti</p>	<p><b>Art. 15389</b>  OEM 975743M1 Anello per frizione di sterzo - dentatura interna 229x171x2 - 21 denti</p>	

# Frizioni e loro componenti

CLUTCHES - CLUTCH DISK - BEARING - COUPLING - LEVER - SET-REVISION

## segue LANDINI CINGOLI

TREKKER C65F  
- C70N/F - C75N/F -  
C80N/F

N.B.: VALEO e LUK  
sono intercambiabili  
fra di loro

**Art. Kit  
16037**

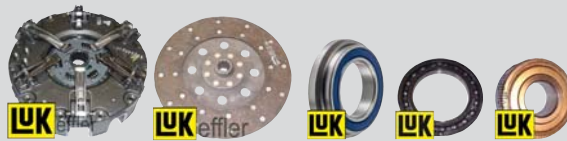

OEM

Kit composto da:  
- Meccanismo 15575  
- Disco PTO 15972  
- Cuscinetti 15990 - 15751 - 63869

**Art. Kit  
15928**



OEM 3532239M93

Kit composto da:  
- Meccanismo 15575  
- Disco PTO 15972

**Art. 15575**



OEM  
3304583M95  
3540480M91  
- Meccanismo a 6  
leve completo di disco  
centrale metalceramico  
a 5 pale - fornito senza  
disco PTO  
- Piatto Ø280 mm (11")

**Art. 15972**



OEM  
1424135M94  
Disco PTO rigido in  
ferodo  
280x165x3 mm  
25x22EV  
Z.10

**Art. 15642**



OEM  
1424135M94  
Disco PTO rigido in  
ferodo  
280x165x3 mm  
25x22EV  
Z.10

**Art. 15414**



OEM 1424149M95  
3304586M91  
Disco centrale  
metalceramico con  
molle parastrappi a 5  
pale Ø 280 sinterizzato  
40x35EV - Z.14

**Art. 15280**



OEM 1423473M94  
Cuscinetto reggispinta  
cambio 90x50x22 mm

**Art. 15990**



OEM 1423473M94  
Cuscinetto reggispinta  
cambio 90x50x22 mm

**Art. 15751**



OEM 1442381X1  
Cuscinetto reggispinta  
PTO 65x100x11 mm

**Art. 15404**



OEM  
392051X1  
Cuscinetto reggispinta  
95x50x21,5 mm

**Art. 62583**



OEM 339599X1 -  
3670612M1  
Cuscinetto volano  
20x47x14 mm

**Art. FAG  
63869**

TREKKER C65F-  
C75F-C80F- C80F/M  
- C85/85F-C90F/M-  
C95/95F-C100/100F/  
C105F/M

**Art. Kit  
15931**



OEM 6521049M91

Kit composto da:  
- Meccanismo 15576  
- Disco PTO 15974

**Art. Kit  
16068**



OEM 6625200A1

Kit composto da:  
- Meccanismo 15576  
- Disco PTO 15974  
- Cuscinetti 15404 - 15751 - 63869

**Art. 15576**



OEM 3532192M96  
3540478M91  
- Meccanismo a 6 leve  
completo di disco centrale  
metalceramico a 8 pale -  
senza il disco PTO  
- Piatto Ø 310 mm (12")

**Art. 15974**



OEM 3105233M92  
3311943M91  
Disco PTO rigido in  
ferodo  
25x22EV  
310x175x3,5 (12")-Z.10

**Art. 15578**



OEM 3105233M92  
3311943M91  
Disco PTO rigido in  
ferodo  
25x22EV  
310x175x3,5 (12") - Z.10

**Art. 15577**



OEM  
3311942M91  
Disco centrale  
metalceramico con  
molle parastrappi 8 pale  
Ø 310 sinterizzato (12")  
40x35EV - Z.14

**Art. 15751**



OEM 1442381X1  
Cuscinetto reggispinta  
PTO 65x100x11

**Art. 15404**



OEM 392051X1  
Cuscinetto reggispinta  
95x50x21,5 mm

**Art. 62583**



OEM 339599X1 -  
3670612M1  
Cuscinetto volano  
20x47x14 mm

**Art. FAG  
63869**

# Frizioni e loro componenti

















CLUTCHES - CLUTCH DISK - BEARING - COUPLING - LEVER - SET-REVISION

11

## segue LANDINI CINGOLI

<p><b>TREKKER NEW</b> 80, 90 (2000-&gt;2003) 75, 85, 95, 105 (2003-&gt;2007) RETYLING 80, 90, 100, 105 (2011-&gt;...)</p>	<p><b>Art. 16210</b></p> 	<p>OEM 3535760M91 Disco sinterizzato per frizione di sterzo</p>		
---	--	---	--	--

## LAVERDA MIETITREBBIE

<p>M84 - M92</p>	<p><b>Art. 15424</b></p> 	<p>OEM Meccanismo monodisco con molle a diaframma Piatto Ø 215 mm</p>	<p><b>Art. 15116</b></p> 	<p>OEM 3.010.07850 Disco frizione rigido in ferodo 216x152x3,5 mm 35x30x4 mm - Z.10</p> <p><b>Art. 15055</b> OEM Cuscinetto reggispinta</p> 
<p>M100 - M112</p>	<p><b>Art. 15425</b></p> 	<p>OEM 3.016.24302 - Meccanismo monodisco a molle elicoidali - Piatto Ø 250 mm</p>	<p><b>Art. 15117</b></p> 	<p>OEM 3.015.25750 Disco frizione centrale rigido in ferodo 250x155x3,5 mm 35x30x4 mm - Z.10</p> <p><b>Art. 15364</b> OEM Manicotto</p> 
<p>M120 - M132 - M150 - TA150 - M152 - M1000 AL - AM 1200</p>			<p><b>Art. 15053</b></p> 	<p>OEM 3.018.48250 Disco frizione centrale rigido in ferodo 275x165x3,5 mm 35x30x4 mm - Z.10</p> <p><b>Art. 15364</b> OEM Manicotto</p> 
<p>M52 (2ª serie) - M152 - AUTOLIVELLANTI: 3450R - 3500</p>			<p><b>Art. 15187</b></p> 	<p>OEM 3.001.14836 Disco frizione centrale rigido in ferodo 300x193x3,6 mm 35x30x4 mm - Z.10</p> <p><b>Art. 15364</b> OEM Manicotto</p> 
<p>3650 - 3650 R - 3750 - 3750 R - 3850 - 3850 R</p>	<p><b>Art. Kit</b> <b>15394</b></p>  <p><b>LUK</b></p>	<p>OEM Disco presa di movimento rigido in ferodo 352x195x4,3 mm 50x45EV - Z.24</p> <p><b>Art. 15445</b></p> 	<p>OEM KIT meccanismo presa di movimento con disco</p>  <p><b>Art. 15410</b> OEM Manicotto con cuscinetto reggispinta</p> 	<p>OEM Disco centrale metalceramico a 7 pale Rigido Ø 350 mm sinterizzato 50x45EV - Z.24</p> <p><b>Art. 15293</b></p>  <p><b>Art. 15883</b> OEM 112x65x42 mm Cuscinetto reggispinta</p> 

## LEO













<p>MOTOZAPPA M4 (10/12/14 HP)</p>	<p><b>Art. 15354</b></p> 	<p>OEM Frizione monodisco a molle elicoidali Piatto Ø 140 mm</p>	<p><b>Art. 15731</b></p> 	<p>OEM Disco frizione rigido 140x96x7,5 mm 17x14x4 mm Z.6</p>
---------------------------------------	--	--	--	---







# Frizioni e loro componenti

CLUTCHES - CLUTCH DISK - BEARING - COUPLING - LEVER - SET-REVISION

## MAB

MOTOCOLTIVATORI PANDA 135 10 HP	<b>Art. 15001</b>  OEM 592431394 Frizione conica Ø 103x100 mm Albero Ø 22,5 mm Conicità 1:5 15x12EV - Z.8			
MOTOZAPPA TALPINA	<b>Art. 15595</b>  OEM Frizione Ø 94 mm a dischi multipli 3 dischi	<b>Art. 15596</b>  OEM Disco 85,5x60x4,5 mm		
MOTOZAPPA	<b>Art. 15597</b>  OEM Frizione Ø 94 mm a dischi multipli 4 dischi	<b>Art. 15596</b>  OEM Disco 85,5x60x4,5 mm		
MOTOZAPPA	<b>Art. 15849</b>  OEM Frizione Ø 103x82 mm a 3 dischi 12x15EV - Z.8 Albero Ø 23 mm	<b>Art. 15630</b>  OEM Disco frizione sinterizzato Ø 93 mm		
MOTOZAPPA (motore HONDA)	<b>Art. 15850</b>  OEM Frizione Ø 103x106 mm a 3 dischi 12x15EV - Z.8 Albero Ø 20 mm	<b>Art. 15630</b>  OEM Disco frizione sinterizzato Ø 93 mm		
MOTOCOLTIVATORE TALPA TRATTORINO TALPA 4 RM	<b>Art. 15016</b>  OEM Frizione monodisco a molle elicoidali Piatto Ø 155 mm	<b>Art. 15033</b>  OEM Disco frizione rigido in ferodo 155x114x4,5 mm 17x14x4 mm - Z.6	<b>Art. 15051</b>  OEM Cuscinetto reggispira	
			<b>Art. 15048</b>  OEM Manicotto	

## MASSEY FERGUSON RUOTE





























MF 33A3 - MF135 (fino al telaio 121069) - MF 133 MK III - MF 135 AD3 (Dal telaio 121070) - MF 135 (fino al telaio 439190) - MF 135MK III Francia - MF 135 MK III Export -	MF 148 MK III - MF 148 (fino al telaio) 605134) - MF 152 - MF 165 (fino al telaio 564619) - MF 175 - MF 178 (fino al telaio 729574) - MF550 - MF560 - MF565 - MF575 - MF765	<b>Art. 15183</b>  OEM 890302M91 3620410M91 Disco frizione centrale rigido in ferodo 273x178x3,5 mm 29x23x4 mm Z.10	<b>Art. 15127</b>  OEM 899823M91 1753753M92 - 3620411M91 Disco PTO rigido in ferodo 225x145x3,5 mm 44x38x7 mm - Z.10
MF 135 (Dal telaio 439191) - MF 148 (Dal telaio 605135) - MF 165 (Dal telaio 564620) - MF 165 Nuova serie - MF 168 - MF 175 Nuova serie - MF 178 (Dal telaio 729575) - MF 185 - MF 188 - MF 235 - MF 240 (fino al telaio 522354) -	MF 245 - MF 250 - MF 255 - MF 260 - MF 265 - MF 275 - MF 290 (Asia - Africa - Australia) - MF 290 (Europa) - MF 575 (Francia) - MF 590 - MF 675 - MF 675/4 - MF 690 - MF 690/4 - MF 1080.8 - MF 1080.8 suffr. - 1845 - 1945 - 283 - 2845 - 293 - 2945 - T/VALEO	<b>Art. 15184</b>  OEM 1866042M93 Disco frizione centrale rigido in ferodo 302x197x4 mm 29x23x4 mm Z.10	<b>Art. 15433</b>  OEM 887900M91 1865836M91 Disco PTO rigido in ferodo 250x155x3,5 mm 44x38x7 mm - Z.10
(segue MASSEY FERGUSON RUOTE)			<b>Art. 15514</b>  OEM Cuscinetto reggispira

# Frizioni e loro componenti

CLUTCHES - CLUTCH DISK - BEARING - COUPLING - LEVER - SET-REVISION

11































## segue MASSEY FERGUSON RUOTE

<p><b>new</b></p> <p>133 fino a matr. 217333 135 made in FR fino a matr. 350000 135 made in GB fino a matr. 1210069 140 fino a matr. 382043 145</p>	<p><b>Art. Kit 16169</b></p>    <p>OEM 962193M94</p> <p>Kit composto da: - Meccanismo 15901 - Disco PTO 15183</p>		
	<p><b>Art. 15901</b></p>  <p>OEM 3620401M91 Meccanismo</p>	<p><b>Art. 15127</b></p>  <p>OEM 899823M91 1753753M92 - 3620411M91 Disco PTO rigido in ferodo 225x145x3,5 mm 44x38x7 mm -Z.10</p>	<p><b>Art. 15183</b></p>  <p>OEM 890302M91 3620410M91 Disco frizione centrale rigido in ferodo 273x178x3,5 mm 29x23x4 mm -Z.10</p>
			<p><b>Art. 15514</b></p>  <p>OEM Cuscinetto reggispinta</p>
<p><b>new</b></p> <p>30E 133 da matr. 275041 135 made in GB da matr. 439191 135 made in FR da matr. 275041 135 da matr. 382043 145 - 148 - 158 - 230 - 231 - 235 - 240 - 245 - 250 - 255 - 261 - 340 - 342 - 350 - 550</p>	<p><b>Art. Kit 16170</b></p>      <p>OEM</p> <p>Kit composto da: - Meccanismo 15891 - Disco PTO 15814 - Cuscinetto 15514</p>		
	<p><b>Art. 15891</b></p>  <p>OEM 3599463M91 3610273M91 1867438M91 Meccanismo Ø 300 mm</p>	<p><b>Art. 15892</b></p>  <p>OEM 3478359M1 1867386M91 3620417M91 Disco PTO rigido organico Ø 250 mm 38x41 mm - Z.25</p>	<p><b>Art. 15184</b></p>  <p>OEM 1866042M91 Disco frizione centrale rigido in ferodo 302x197x4 mm 29x23x4 mm -Z.10</p>
		<p><b>Art. 15433</b></p>  <p>OEM 887900M91 1865836M91 Disco PTO rigido in ferodo 250x155x3,5 mm 44x38x7 mm -Z.10</p>	<p><b>Art. 15514</b></p>  <p>OEM Cuscinetto reggispinta</p>
<p>165 168 178</p>	<p><b>Art. 15902</b></p>  <p>OEM 3620402M91 Meccanismo Ø 280 mm</p>	<p><b>Art. 15127</b></p>  <p>OEM 899823M91 1753753M92 - 3620411M91 Disco PTO rigido in ferodo 225x145x3,5 mm 44x38x7 mm -Z.10</p>	<p><b>Art. 15183</b></p>  <p>OEM 890302M91 3620410M91 Disco frizione centrale rigido in ferodo 273x178x3,5 mm 29x23x4 mm -Z.10</p>
			<p><b>Art. 15514</b></p>  <p>OEM Cuscinetto reggispinta</p>
<p>185 fino a matr. 317618 188 da matr. 358839</p>	<p><b>Art. 15903</b></p>  <p>OEM 1867005M91 Meccanismo Ø 300 mm</p>	<p><b>Art. 15184</b></p>  <p>OEM 1866042M91 Disco frizione centrale rigido in ferodo 302x197x4 mm 29x23x4 mm -Z.10</p>	<p><b>Art. 15892</b></p>  <p>OEM 3478359M1 1867386M91 3620417M91 Disco PTO rigido organico Ø 250 mm 38x41 mm -Z.25</p>
			<p><b>Art. 15514</b></p>  <p>OEM Cuscinetto reggispinta</p>
<p>3680 3690 3670</p> <p>(segue MASSEY FERGUSON RUOTE)</p>	<p><b>Art. Kit 15904</b></p>    <p>OEM 3580944M92 Meccanismo bi-disco Ø 310 mm</p>		

# Frizioni e loro componenti

CLUTCHES - CLUTCH DISK - BEARING - COUPLING - LEVER - SET-REVISION

## segue MASSEY FERGUSON RUOTE





























<p>2405 2410 2415</p>	<p><b>Art. Kit 15987</b></p>   	<p>OEM 0.012.5851.4/20 Kit frizione doppia a 6 leve con disco interno Ø 230 mm</p>	
		<p><b>Art. 62952</b> OEM Cuscinetto reggispinta PTO 75x115x20 mm</p>  <p><b>Art. FAG 63897</b></p>	<p><b>Art. 62577</b> OEM Cuscinetto volano 15x35x11 mm</p>  <p><b>Art. FAG 63863</b></p>
<p>154S - 174S - 233 - 234S - 253 - 254S.4WD - 263 - 273 - 274S 134C/V - 154N/F/S/V - 164T/F/S/V 184S - 194S - 283 - 284S.4WD - 293 - 294S.4WD</p>	<p><b>Art. 15574</b> OEM 3303238M93 3303000M96 - 3540479M91 - Meccanismo a 6 leve completo di disco centrale molleggiato in ferodo - fornito senza disco PTO - Piatto Ø 280 mm (11")</p> 	<p><b>Art. 15972</b> OEM 1424135M94 Disco PTO rigido in ferodo 280x165x3 mm 25x22EV Z.10</p> 	<p><b>Art. 15642</b> OEM 1424135M93 Disco PTO rigido in ferodo 280x165x3 mm 25x22EV Z.10</p> 
	<p><b>Art. 15147</b> OEM 3311538M92 Disco centrale in ferodo con molle parastrappi 280x165x4,4 mm 40x35EV - Z.14</p> 	<p><b>Art. 15404</b> OEM 392051X1 Cuscinetto reggispinta 95x50x21,5 mm</p> 	<p><b>Art. 15751</b> OEM 1442381X1 Cuscinetto reggispinta PTO 65x100x11 mm</p> 
	<p><b>Art. 15990</b> OEM 1424135M94 Cuscinetto reggispinta cambio 90x50x22 mm</p> 	<p><b>Art. 15280</b> OEM 1424135M94 Cuscinetto reggispinta cambio 90x50x22 mm</p> 	<p><b>Art. 62583</b> OEM 339599X1 - 3670612M1 Cuscinetto volano 20x47x14 mm</p>  <p><b>Art. FAG 63869</b></p>
	<p><b>Art. Kit 16037</b></p>      	<p>OEM Kit composto da: - Meccanismo 15575 - Disco PTO 15972 - Cuscinetti 15990 - 15751 - 63869</p>	
	<p><b>Art. Kit 15928</b></p>   	<p>OEM Kit composto da: - Meccanismo 15575 - Disco PTO 15972</p>	
<p>(segue MASSEY FERGUSON RUOTE)</p>	<p><b>Art. 15575</b> OEM 3304583M95 3540480M91 - Meccanismo a 6 leve completo di disco centrale metalceramico a 5 pale - fornito senza disco PTO - Piatto Ø 280 mm (11")</p> 	<p><b>Art. 15972</b> OEM 1424135M94 Disco PTO rigido in ferodo 280x165x3 mm 25x22EV - Z.10</p> 	<p><b>Art. 15642</b> OEM 1424135M94 Disco PTO rigido in ferodo 280x165x3 mm 25x22EV - Z.10</p> 
	<p><b>Art. 15414</b> OEM 1424149M95 3304586M91 Disco centrale metalceramico con molle parastrappi a 5 pale 280 sinterizzato 40x35EV - Z.14</p> 	<p><b>Art. 15990</b> OEM 1424135M94 Cuscinetto reggispinta cambio 90x50x22 mm</p> 	<p><b>Art. 15280</b> OEM 1423473M94 Cuscinetto reggispinta cambio 90x50x22 mm</p> 
		<p><b>Art. 15751</b> OEM 1442381X1 Cuscinetto reggispinta PTO 65x100x11 mm</p> 	

# Frizioni e loro componenti

CLUTCHES - CLUTCH DISK - BEARING - COUPLING - LEVER - SET-REVISION

11

## segue MASSEY FERGUSON RUOTE

1014	<b>Art. Kit 16071</b>  	OEM 3541015M92 - 3302447M91 - 3302477M92 Kit composto da: - Meccanismo 15579 - Disco PTO 15419 - Cuscinetti 15742 - 15752 - 63872		
	<b>Art. 15579</b>  	<b>Art. 15419</b>  	<b>Art. 15418</b> 	OEM 3310761M91 Disco centrale metalceramico rigido Ø 310 sinterizzato 48x44EV - Z.23
	<b>Art. 15742</b> 	<b>Art. 15752</b> 	<b>Art. 62586</b> 	OEM 3302143M91 Cuscinetto reggispinta cambio - 97x55x30 mm OEM 39219X1 Cuscinetto reggispinta PTO - 75x115x13 mm OEM 392168X1 Cuscinetto volano 25x52x15 mm <b>Art. FAG 63872</b>
377 - 387 - 397	<b>Art. Kit 15931</b>  	OEM 6521049M91 Kit composto da: - Meccanismo 15576 - Disco PTO 15974		
	<b>Art. Kit 16068</b>  	OEM 6625200A1 Kit composto da: - Meccanismo 15576 - Disco PTO 15974 - Cuscinetti 15404 - 15751 - 63896		
	<b>Art. 15576</b>  	<b>Art. 15974</b>  	<b>Art. 15578</b> 	OEM 3532192M96 3540478M91 - Meccanismo a 6 leve completo di disco centrale metalceramico a 8 pale - senza il disco PTO - Piatto Ø 310 mm (12") OEM 3105233M92 3311943M91 Disco PTO rigido in ferodo 25x22EV 310x175x3,5 mm (12") Z.10
	<b>Art. 15577</b> 	<b>Art. 15751</b> 	<b>Art. 15404</b> 	OEM 3105232M91 3311942M91 Disco centrale metalceramico con molle parastrappi 8 pale Ø 310 mm sinterizzato (12") 40x35EV - Z.14 OEM 1442381X1 Cuscinetto reggispinta PTO 65x100x11 mm OEM 392051X1 Cuscinetto reggispinta 95x50x21,5 mm <b>Art. 62583</b> 
390T - 396 - 398 - 399 4240 - 4245/HV - 4255/HV - 4260 - 4265 - 4270 4355 - 4360 - 4365 - 4370	<b>Art. Kit 16147</b>  	OEM Kit frizione Ø 330 mm a 3 leve completo di: Disco a 5 pale Ø 330 Z.21 con molle parastrappi. Cuscinetto 63,5x100x23 Cuscinetto 17x40x12		
	<b>Art. Kit 15726</b>  	OEM Frizione semplice con disco avanzamento in organico - Piatto Ø 280 mm		
2200 - 2205 - 2210 - 2220	<b>Art. 15908</b>  	OEM Disco frizione Ø 280 mm - 31x35 mm - Z.18		























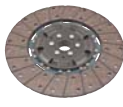





(segue MASSEY FERGUSON RUOTE)



# Frizioni e loro componenti

CLUTCHES - CLUTCH DISK - BEARING - COUPLING - LEVER - SET-REVISION







## segue MASSEY FERGUSON RUOTE

1007 - 1014 - 1024 - 1114 - 1134	<b>Art. Kit 15933</b>   	OEM Kit composto da: - Meccanismo 15580 - Disco PTO 15973	
	<b>Art. 15580</b>  OEM 3303137M95 3540481M91 -1426390M94 - Meccanismo a 6 leve completo di disco centrale metalceramico a 6 pale - senza il disco PTO - Piatto Ø 330 mm - 13"	<b>Art. 15973</b>  OEM 1426390M93 Disco PTO rigido in ferodo 327x175x3,8 mm 30x27EV Z.16	<b>Art. 15422</b>  OEM 1426390M93 Disco PTO rigido in ferodo 327x175x3,8 mm 30x27EV Z.16
	<b>Art. 15421</b>  OEM 1426389M91-3302049M93 Disco centrale metalceramico rigido a 6 pale Ø 327 mm sinterizzato 48x44EV - Z.23	<b>Art. 15419</b>  OEM 3310234M91 3105367M91 Disco PTO rigido in ferodo 310x175x3,5 mm 30x27EV - Z.16	
	<b>Art. 15742</b>  OEM 3302143M91 Cuscinetto reggispinta cambio - 97x55x30 mm	<b>Art. 15752</b>  OEM 392191X1 Cuscinetto reggispinta PTO 75x115x13 mm	<b>Art. 62586</b>  OEM 392168X1 Cuscinetto volano 25x52x15 mm  <b>Art. FAG 63872</b>
3050 - 3070 - 3080 3090 - 3095	<b>Art. 15647</b>  OEM 3713531M1 Meccanismo con molle a diaframma Piatto Ø 330 mm	<b>Art. 15964</b>  OEM Disco centrale in ferodo con molle parastrappi 330x196x4,2 mm 41x36,5EV - Z.24	<b>Art. 15803</b>  OEM Disco centrale in ferodo con molle parastrappi 330x196x4,2 mm 41x36,5EV - Z.24
	<b>Art. 15965</b>  OEM Disco centrale metalceramico a 6 pale con molle parastrappi Ø 330 mm sinterizzato 41x45,3 mm - Z.21	<b>Art. 15749</b>  OEM Disco centrale metalceramico a 6 pale con molle parastrappi Ø 330 mm sinterizzato 41x45,3 mm - Z.21	<b>Art. 15292</b>  Disco centrale metalceramico a 7 pale con molle parastrappi Ø 330 mm - 50x46V - Z.23
	<b>Art. 15984</b>  OEM 0.016.6105.3 Disco centrale metalceramico a 6 pale con molle parastrappi Ø 330 mm sinterizzato 41x36,5EV - Z.24	<b>Art. 15744</b>  OEM 2.2999.475.0 Cuscinetto reggispinta 90x55x22 mm	<b>Art. 15883</b>  OEM 2.2999.510.0 2.2999.207.0 2.2999.443.0 112x65x42 mm Cuscinetto reggispinta
155 - 158 - 165 - 168 - 265 - 275	<b>Art. Kit 16173</b>     		OEM 3599494M92 Kit frizione a 3 leve Ø 300 mm completo di: Disco PTO in acciaio 38x41 Z.25 Disco centrale rigido in ferodo 23x29 Z.10 Cuscinetto 63,5x100x22 Cuscinetto 17x40x12
185 - 188 - 285 (motore 4.248) - 290	<b>Art. Kit 16174</b>     		OEM 3599496M93 Kit frizione a 3 leve Ø 300 mm completo di: Disco PTO in acciaio 38x41 Z.25 Disco centrale rigido in ferodo 23x29 Z.10 Cuscinetto 63,5x100x22 Cuscinetto 17x40x12

# Frizioni e loro componenti

CLUTCHES - CLUTCH DISK - BEARING - COUPLING - LEVER - SET-REVISION





















## segue MASSEY FERGUSON RUOTE

3645 F/GE/S 3655 F/GE/S	<b>Art. Kit 16222</b>    	OEM VA205510
	<b>Art. Kit 16223</b>    	OEM VA205511

Kit composto da:  
 - Meccanismo Ø 310  
 - Disco sinterizzato a 5 pale  
 - Cuscinetto

Kit composto da:  
 - Meccanismo Ø 310  
 - Disco sinterizzato a 6 pale  
 - Cuscinetto

## MASSEY FERGUSON CINGOLI

MF 101C	<b>Art. 15206</b>  OEM 973372M1 Anello per frizione di sterzo in ferodo dentatura esterna 219,2x152x6 mm - 71 denti			
MF 134C - MF 154C - MF 174C	<b>Art. Kit 15928</b>   	OEM	Kit composto da: - Meccanismo 15575 - Disco PTO 15972	
	<b>Art. 15575</b>  OEM 3304583M95 3540480M91 - Meccanismo a 6 leve completo di disco centrale metalceramico a 5 pale - fornito senza disco PTO - Piatto Ø 280 mm (11")	<b>Art. 15972</b>  OEM 1424135M94 Disco PTO rigido in ferodo 280x165x3 mm 25x22EV - Z.10	<b>Art. 15642</b>  OEM 1424135M94 Disco PTO rigido in ferodo 280x165x3 mm 25x22EV - Z.10	
	<b>Art. 15414</b>  OEM 1424149M95 3304586M91 Disco centrale metalceramico con molle parastrappi a 5 pale 280 sinterizzato 40x35EV - Z.14	<b>Art. 15404</b>  OEM 392051X1 Cuscinetto reggispinta 95x50x21,5 mm	<b>Art. 15751</b>  OEM 1442381X1 Cuscinetto reggispinta PTO 65x100x11 mm	
	<b>Art. 15990</b>  OEM 1424135M94 Cuscinetto reggispinta cambio 90x50x22 mm	<b>Art. 15280</b>  OEM 1423473M94 Cuscinetto reggispinta cambio 90x50x22 mm	<b>Art. 62583</b>  OEM 339599X1 - 3670612M1 Cuscinetto volano 20x47x14 mm <b>Art. FAG 63869</b>	
	<b>Art. 15423</b>  OEM 1824733M1 Anello per frizione di sterzo - in tessuto - dentatura esterna 239x180x5 mm - 28 denti	<b>Art. 15389</b>  OEM 975743M1 Anello per frizione di sterzo - dentatura interna 229x171x2 mm - 21 denti		
	<b>Art. 15940</b>   solo per MF134C-154C	OEM 1423838M91 1423980M91-1850838M91-3306277M91 Meccanismo monodisco Ø 250 mm a 3 leve con collare e disco PTO	<b>Art. 15234</b>  OEM Disco frizione rigido 250x155x4,3 mm 35x29x5,5 mm Z.10	
	<b>Art. 15945</b>  OEM Meccanismo monodisco Ø 280 mm solo per MF174C	<b>Art. 15169</b>  OEM Disco frizione rigido 279x171x4,3 mm 35x29x5,5 mm Z.10		

















(segue MASSEY FERGUSON CINGOLI)

# Frizioni e loro componenti

CLUTCHES - CLUTCH DISK - BEARING - COUPLING - LEVER - SET-REVISION

11

## segue MASSEY FERGUSON CINGOLI

MF 144C - MF 164C	<b>Art. 15111</b>  OEM 1424123M91 Disco centrale rigido in ferodo 280x165x3,8 mm 40x35EV - Z.14	<b>Art. 15972</b>  OEM 1424135M91 Disco PTO rigido in ferodo 280x165x3 mm 25x22EV - Z.10	<b>Art. 15642</b>  OEM1424135M91 Disco PTO rigido in ferodo 280x165x3,5 mm 25x22EV - Z.10
	<b>Art. 15423</b>  OEM 1824733M1 Anello per frizione di sterzo - in tessuto - dentatura esterna 239x180x5 mm - 28 denti	<b>Art. 15389</b>  OEM 975743M1 Anello per frizione di sterzo - dentatura interna 229x171x2 mm - 21 denti	
MF 194C	<b>Art. 15414</b>  OEM 3304584M92 1424149M95 3306586M91 Disco centrale metalceramico con molle parastrappi a 5 pale Ø 280 mm sinterizzato 40x35EV - Z.14	<b>Art. 15972</b>  OEM 1424135M91 Disco PTO rigido in ferodo 280x165x3 mm 25x22EV - Z.10	<b>Art. 15642</b>  OEM 1424135M91 Disco PTO rigido in ferodo 280x165x3,5 mm 25x22EV - Z.10
			<b>Art. 15178</b>  OEM 3300186M1 Anello per frizione di sterzo in ferodo - dentatura esterna 271x201x5 mm 89 denti
MF 234CF - MF 254C - MF 254CF - MF 274C - MF 274CF	<b>Art. 15972</b>  OEM 1424135M91 Disco PTO rigido in ferodo 280x165x3 mm 25x22EV - Z.10	<b>Art. 15642</b>  OEM 1424135M91 Disco PTO rigido in ferodo 280x165x3,5 mm 25x22EV - Z.10	
	<b>Art. 15423</b>  OEM 1824733M1 Anello per frizione di sterzo - in tessuto - dentatura esterna 239x180x5 mm - 28 denti	<b>Art. 15389</b>  OEM 975743M1 Anello per frizione di sterzo - dentatura interna 229x171x2 mm - 21 denti	
MF 294C	<b>Art. 15414</b>  OEM 3304584M92 1424149M95 3306586M91 Disco centrale metalceramico con molle parastrappi a 5 pale Ø 280 mm sinterizzato 40x35EV - Z.14	<b>Art. 15972</b>  OEM 1424135M91 Disco PTO rigido in ferodo 280x165x3 mm 25x22EV - Z.10	<b>Art. 15642</b>  OEM 1424135M91 Disco PTO rigido in ferodo 280x165x3,5 mm 25x22EV - Z.10









## MIRA

MOTAZAPPA MOTOCOLTIVATORE	<b>Art. 15851</b>  OEM Frizione Ø 103x87 mm a 4 dischi 12x15EV Z.8 - Albero Ø 23 mm		
------------------------------	---	--	--









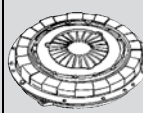

# Frizioni e loro componenti

CLUTCHES - CLUTCH DISK - BEARING - COUPLING - LEVER - SET-REVISION

## NIBBI BRUNO

TRATTORINI: G119 - G219 - G520 - G521	<b>Art. 15296</b> OEM  Meccanismo monodisco a molle elicoidali Piatto Ø 184 mm	<b>Art. 15213</b> OEM  Disco frizione rigido in ferodo 184x127x3,5 mm 25x21EV Z.15	<b>Art. 15052</b> OEM  Cuscinetto reggispinta 68x36x19 mm
			<b>Art. 15047</b> OEM  Manicotto
MOTOCOLTIVATORI G519 - G719	<b>Art. 15644</b> OEM  Disco frizione rigido 100x63x2 mm 24,5x20EV - Z.15 per G719	<b>Art. 15645</b> OEM  Disco frizione rigido 135x91x2,2 mm 24,5x20EV - Z.15 per G519	
TRATTORINI: 344 (doppia frizione)	<b>Art. 15098</b> OEM  Disco centrale rigido in ferodo 216x152x3,8 mm 35x31EV - Z.18	<b>Art. 15099</b> OEM  Disco PTO rigido in ferodo 216x152x3,9 mm 23x20EV - Z.20	

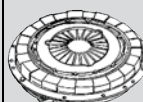
## NIBBI DECIMO

MOTAZAPPA CON MOTORE MINARELLI	<b>Art. 15598</b> OEM  Frizione conica Ø 103x79 mm Albero Ø 16,7 mm Conicità 1:5 15x12EV - Z.8		
MOTAZAPPA	<b>Art. 15604</b> OEM  Frizione multidisco Ø 114 mm Completa di dischi	<b>Art. 15605</b> OEM  Serie dischi completa 104x77,5x2,6 mm	
MOTOCOLTIVATORI MAJOR	<b>Art. 15002</b> OEM  Frizione monodisco a molle a diaframma Piatto Ø 110 mm	<b>Art. 15019</b> OEM  Disco frizione rigido 110x58x1,5 mm 15x12EV - Z.8	<b>Art. 15042</b> OEM  Manicotto con cuscinetto reggispinta
		<b>Art. 15050</b> OEM  Cuscinetto reggispinta	<b>Art. 15057</b> OEM  Leva a forcella
MOTOCOLTIVATORI GRIFO - ARGO MOTAZAPPA GRIFO EXTRA	<b>Art. 15215</b> OEM  Disco frizione rigido 120x78x3 mm 17x14EV - Z.9 Solo per motocoltivatori GRIFO e ARGO	<b>Art. 15643</b> OEM  Disco frizione rigido 144x102x3 mm 26x21x3V - Z.10 Solo per motozappa GRIFO EXTRA	
MOTOCOLTIVATORI	<b>Art. 15339</b> OEM  Frizione bidisco completa di disco centrale Piatto Ø 110 mm	<b>Art. 15022</b> OEM  Disco frizione rigido in sinterizzato Ø 110 mm sinterizzato 15x12EV - Z.8	<b>Art. 15042</b> OEM  Manicotto con cuscinetto reggispinta























# Frizioni e loro componenti

CLUTCHES - CLUTCH DISK - BEARING - COUPLING - LEVER - SET-REVISION

11







## PASQUALI

SERIE 938 - 939 - 952 - 953	<b>Art. 15318</b> 	OEM 939.183.0 Frizione conica Ø 103x69 mm Albero Ø 22,5 mm Conicità 1:5 15x12EV - Z.8		
MOTOCOLTIVATORI 461 - 475 - 478 (DAL 1995 IN AVANTI)	<b>Art. 15606</b> 	OEM Frizione Ø 103x68 mm a dischi multipli con 5 dischi 15x12EV - Z.8 Albero Ø23 - Conicità 1:5	<b>Art. 15630</b> 	OEM 15653 Disco frizione Ø 93 mm <b>Art. 15653</b> OEM  Serie dischi
MOTOFALCIATRICI (DAL 1995 IN AVANTI)	<b>Art. 15607</b> 	OEM Frizione Ø 103x85,5 mm a dischi multipli con 6 dischi 15x12EV - Z.8 Albero Ø 22,5 Conicità 1:5	<b>Art. 15630</b> 	OEM 15654 Disco frizione Ø 93 mm <b>Art. 15654</b> OEM  Serie dischi
MOTOCOLIVATORI: 921 - 922 - 934 - 917 - 923 - 924 - 933	<b>Art. 15007</b> 	OEM Meccanismo monodisco a molle elicoidali Piatto Ø 160 mm	<b>Art. 15039</b> 	OEM Disco frizione rigido in ferodo 160x108x2,5 mm 22x19x3,5 mm - Z.10
MOTOCOLIVATORI: 904	<b>Art. 15880</b> 	OEM Meccanismo frizione Piatto Ø 160 mm	<b>Art. 15216</b> 	OEM 930.1020 Disco frizione rigido in ferodo 160x108x3,5 mm 29,5x23x4 - Z.10
MOTOCOLIVATORI: 906 - 910 (18 HP) 931 - 937 - 940 - 941 944 - 945 - 946 - 946T - 947 - 986	<b>Art. 15538</b> 	OEM 4240200 Frizione monodisco con molle elicoidali Ø 180 mm	<b>Art. 15041</b>  Motocoltiv. 945	OEM Disco frizione rigido in ferodo 180x124x3,5 mm 29,5x23x4 mm - Z.10 <b>Art. 15669</b> OEM  Reggispinta con battente 30x62x20 mm appoggio piano
Serie 940 - 941 - 944 - 945 - 946 - 947 - 986	<b>Art. 16152</b> 	OEM Meccanismo monodisco a 3 leve Ø 180 mm	<b>Art. 15146</b> 	OEM Disco frizione rigido in ferodo - mozzo bombato 180x124x3,5 mm 29x23x4,5 (SAE 1 1/8") - Z.10 <b>Art. 15669</b> OEM  Reggispinta con battente 30x62x20 mm appoggio piano
910 - 931 - 937 - 940 - 941 - 944 - 945 - 946 - 947 - 946T - 986T - 988T - MD 23 - 24 MOZZO BOMBATO	<b>Art. 15217</b> 	OEM Disco frizione rigido in ferodo 181x124x3,5 mm 29x23x4 mm - Z.10	<b>Art. 16046</b> 	OEM 4240190 Manicotto con cuscinetto reggispinta 33,5x136x44 mm appoggio piano <b>Art. 15669</b> OEM  Reggispinta con battente 30x62x20 mm appoggio piano
906 - 910 MOZZO BOMBATO 985 2° Serie  (segue PASQUALI)	<b>Art. 15146</b> 	OEM Disco frizione rigido in ferodo - mozzo bombato 180x124x3,5 mm 29x23x4,5 (SAE 1 1/8") - Z.10		

# Frizioni e loro componenti

CLUTCHES - CLUTCH DISK - BEARING - COUPLING - LEVER - SET-REVISION

















## segue PASQUALI

956 - 957 - 958 - 959 970 - 990 - 991 - 993 995 - 996 - 997 - 988	 <b>Art. 15539</b> OEM 990.118.0 988.136.0-988.136.1 Frizione monodisco con molle a diaframma Piatto Ø 190 mm	 <b>Art. 15218</b> OEM 990.123.1 Disco frizione rigido in ferodo 190x131x4 mm 29x23x4 mm - Z.10	 <b>Art. 15669</b> OEM Reggispinta con battente 35x62x14 mm appoggio piano
	 <b>Art. 15941</b> OEM 9881361 Meccanismo monodisco a 3 leve Ø 190 mm	 <b>Art. 15798</b> OEM 990.123.1 Disco frizione rigido in ferodo con parastrappi 190x131x4 mm 29x23x4 mm - Z.10	 <b>Art. 16046</b> OEM 4240190 Manicotto con cuscinetto reggispinta 33,5x136x44 mm appoggio piano

# Frizioni e loro componenti

CLUTCHES - CLUTCH DISK - BEARING - COUPLING - LEVER - SET-REVISION

## PGS









MOTOCOLIVATORI: ATTILA 11 - SERIE SMERALDO	<b>Art. 15016</b> OEM  Frizione monodisco a molle elicoidali Piatto Ø 155 mm	<b>Art. 15034</b> OEM  Disco frizione rigido in ferodo 155x114x4,5 mm 19x16x3 mm - Z.10	<b>Art. 15048</b> OEM  Manicotto
	<b>Art. 15051</b> OEM  Cuscinetto reggispinta	<b>Art. 15059</b> OEM  Leva a forcella	
MOTOCOLIVATORI: F10	<b>Art. 15007</b> OEM  Meccanismo monodisco a molle elicoidali Piatto Ø 160 mm	<b>Art. 15040</b> OEM  Disco frizione rigido in ferodo 160x108x3,2 mm 22x19x3,5 mm Z.10	
MOTOCOLIVATORI: F13 - F14 - F16 - L 15 - ATTILA SUPER  DUMPER 2096 3078	<b>Art. 15296</b> OEM  Frizione monodisco a molle elicoidali Piatto Ø 187 mm	<b>Art. 15038</b> OEM  Disco frizione rigido in ferodo 184x127x3,8 mm 22x18x3,5 mm - Z.10	
	<b>Art. 15052</b> OEM  Cuscinetto reggispinta 68x36x19 mm	<b>Art. 15047</b> OEM  Manicotto	
TRATTORINI: ROMA 38	<b>Art. 15006</b> OEM 0703915037 Frizione monodisco con molle elicoidali Piatto 187 mm	<b>Art. 15038</b> OEM  Disco frizione rigido in ferodo 184x127x3,8 mm 22x18x3,5 mm Z.10	
	<b>Art. 15052</b> OEM 08210 Cuscinetto reggispinta 68x36x19 mm	<b>Art. 15047</b> OEM 03018 Manicotto	
TRATTORINI: ROMA 500 - R55 - TRANSPORTER 450	<b>Art. 15009</b> OEM 00184 Frizione monodisco con molle elicoidali Piatto 215 mm	<b>Art. 15027</b> OEM 02922 Disco frizione rigido in ferodo 216x152x3,5 mm 22x18x3,5 mm - Z.10	
	<b>Art. 15052</b> OEM 08210 Cuscinetto reggispinta 68x36x19 mm	<b>Art. 15047</b> OEM 03018 Manicotto	
CARRELLO ELEVATORE D200S - D3000S 2500 OVERLAND	<b>Art. 15345</b> OEM  Meccanismo monodisco a molle elicoidali Piatto Ø 250 mm	<b>Art. 15234</b> OEM  Disco frizione rigido in ferodo 250 mm 35x29 mm Z.10	<b>Art. 15365</b> OEM  Cuscinetto reggispinta
			<b>Art. 15364</b> OEM  Manicotto

# Frizioni e loro componenti

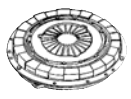



CLUTCHES - CLUTCH DISK - BEARING - COUPLING - LEVER - SET-REVISION

11







## PINZA - GRILLO

MOTOZAPPE: 9000 - 9000R - MOTOCOLTIVATORI: GRILLO GN 10/12	<b>Art. 15354</b> OEM  Frizione monodisco a molle elicoidali Piatto Ø 140 mm	<b>Art. 15219</b> OEM 9037 Disco frizione rigido in ferodo 140x96x3,8 mm 16x13x3,5 mm - Z.6	
MOTOCOLTIVATORI: GRILLO (2ª serie)	<b>Art. 15016</b> OEM 50709  Frizione monodisco a molle elicoidali Piatto Ø 155 mm	<b>Art. 15032</b> OEM 7052 Disco frizione rigido 155x114x4,5 mm 16x13x3,5 mm - Z.6	
MOTOCOLTIVATORI: GRILLINO 127 - GRILLINO 1100 - MOTOFALCIATRICI: BL / BC	<b>Art. 15001</b>  Frizione conica Ø 103x100 mm Albero Ø 22,5 mm Conicità 1:5 15x12EV - Z.8		
MOTOCOLTIVATORI: 131	<b>Art. 15381</b> OEM  Frizione monodisco a molle a diaframma Piatto Ø 160 mm	<b>Art. 15220</b> OEM 13242 Disco frizione rigido in ferodo 160x110x3,8 mm 16x13x3,5 mm - Z.6	
TRATTORE 40 HP	<b>Art. 15010</b> OEM  Frizione monodisco con molle elicoidali Piatto 215 mm	<b>Art. 15221</b> OEM Disco frizione rigido in ferodo 216x152x4 mm 22x18x3,5 mm - Z.10	<b>Art. 15052</b> OEM  Cuscinetto reggispinta 68x36x19 mm
MOTOFALCIATRICI MOTOCOLTIVATORI 130	<b>Art. 15594</b>  Frizione conica Ø 103x98,5 mm Albero Ø 22,5 mm Conicità 1:5 15x12EV - Z.8		
MOTOFALCIATRICI MOTOCOLTIVATORI	<b>Art. 15527</b>  Frizione Ø 103x99 mm a dischi multipli con 5 dischi 15x12EV - Z.8 Albero Ø23 Conicità 1:5	<b>Art. 15584</b> OEM  Serie dischi completa composta da 5 dischi di Ø 93 mm	

## POLENTES

TRATTORINO PIERRE	<b>Art. 15006</b> OEM  Frizione monodisco a molle elicoidali Piatto Ø 187 mm	<b>Art. 15038</b> OEM  Disco frizione rigido in ferodo 184x127x3,8 mm 22x18x3,5 mm Z.10	<b>Art. 15047</b> OEM  Cuscinetto reggispinta
			<b>Art. 15052</b> OEM  Cuscinetto reggispinta 68x36x19 mm

## RANDI







MOTOCOLTIVATORE 2500 - 2500 SUPER - 3000 - 3500 - 4000 - 6000 JUNIOR	<b>Art. 15016</b> OEM  Frizione monodisco con molle elicoidali Piatto Ø 155 mm	<b>Art. 15025</b> OEM  Disco frizione rigido in ferodo 160x110x3,8 mm 19x15,5x3 mm Z.10	<b>Art. 15051</b> OEM  Cuscinetto reggispinta
			<b>Art. 15359</b> OEM  Manicotto
MOTOCOLTIVATORI 3600 TRATTORINI R421 - R424	<b>Art. 15296</b>  Meccanismo monodisco a molle elicoidali Piatto Ø 184 mm	<b>Art. 15026</b>  Disco frizione rigido 184x127x3,8 mm 19x15,5x3 mm - Z.10	<b>Art. 15052</b>  Cuscinetto reggispinta 68x36x19 mm





# Frizioni e loro componenti

CLUTCHES - CLUTCH DISK - BEARING - COUPLING - LEVER - SET-REVISION









## RAPID

MOTOFALCIATRICE ALLTRAC	<b>Art. 15149</b> 	OEM Frizione monodisco a molle elicoidali Piatto Ø 215 mm		
MOTOFALCIATRICE ALLTRAC	<b>Art. 15010</b> 	OEM Frizione monodisco con molle elicoidali Piatto 215 mm		
MOTOCOLTIVATRICE EURO 3	<b>Art. 15321</b> 	OEM Frizione monodisco con molla a diaframma Piatto Ø 95 mm	<b>Art. 15189</b> 	OEM Disco frizione rigido in ferodo 94x61x1,5 mm 15x12EV - Z.8
MOTOCOLTIVATRICE 505	<b>Art. 15733</b> 	OEM Frizione monodisco con molle elicoidali Piatto 160 mm	<b>Art. 15734</b> 	OEM 44218 Disco PTO rigido in ferodo Ø 160 mm 20x18EV - Z.18

## ROTECO

MOTOZAPPA	<b>Art. 15735</b> 	OEM Frizione conica Ø 103x94,5 mm Albero Ø 23 mm Conicità 1:5 15x12 mm - Z.8		
MOTOCOLTIVATORE 10/14 HP	<b>Art. 15013</b> 	OEM Frizione monodisco con molle a diaframma Piatto 160 mm	<b>Art. 15198</b> 	OEM Disco frizione rigido 155x110x4 mm 17x15 ASA 32/64 Z.20

## RENAULT (CLAAS)

























CERES 75/X - 95X - 320/X - 325/X - 335/X - 340/X - 345/X ERGOS 95 - 105	<b>Art. Kit 16049</b>  <b>LUK</b>	 <b>LUK</b>	 <b>LUK</b>	OEM  Kit composto da: - Meccanismo 15919 - Disco PTO 15920
	<b>Art. 15919</b>  <b>LUK</b>	OEM 7700062285 7700058654 Meccanismo a 6 leve Ø 310 mm con disco interno 40x45 mm - Z.16	<b>Art. 15920</b>  <b>LUK</b>	<b>Art. 15755</b>  OEM 7700069705 - 7700515751 - 7700653344 Cuscinetto reggisplinta 96,5x65x23,5 mm
			<b>Art. 62580</b>  <b>Art. FAG 63866</b>	<b>Art. 15756</b>  OEM 7700069706 - 7700653343 Cuscinetto reggisplinta PTO 106x139,5x25 mm

# Frizioni e loro componenti





CLUTCHES - CLUTCH DISK - BEARING - COUPLING - LEVER - SET-REVISION

11

## segue RENAULT (CLAAS)

CERES 320/X - 325/X - 335/X - 340/X - 345/X CERGOS 330 - 335	<b>Art. 15919</b>  LUK	OEM 7700062285 7700058654 Meccanismo a 6 leve Ø 310 mm con disco interno 40x45 mm - Z.16	<b>Art. 15925</b>  LUK	OEM 7700052919 Disco PTO a 4 pale Ø 280 mm 21x25 mm - Z.13	<b>Art. 15755</b> 	OEM 7700069705 - 7700515751 - 7700653344 Cuscinetto reggispinta 96,5x65x23,5 mm
			<b>Art. 62580</b>  LUK	OEM 7700620323 Cuscinetto 17x40x12 mm	<b>Art. FAG 63866</b>	<b>Art. 15756</b> 
CERGOS 350 CERGOS 355	<b>Art. Kit 16074</b>  LUK	 LUK	 LUK	OEM 6005705428  Kit composto da: - Meccanismo 15944 - Disco PTO 15920		
	<b>Art. 15944</b>  LUK	OEM 7700060339 - 0011309880 Meccanismo a 6 leve Ø 330 mm con disco interno 40x45 mm - Z.16 - 5 pale	<b>Art. 15920</b>  LUK	OEM 7700060873 Disco PTO Ø 310 mm 21,7x25 mm - Z.13	<b>Art. 15755</b> 	OEM 7700069705 - 7700515751 - 7700653344 Cuscinetto reggispinta 96,5x65x23,5 mm
					<b>Art. 15756</b> 	OEM 7700069706 - 7700653343 Cuscinetto reggis. PTO 106x139,5x25 mm
DIONIS 110-140 FRUCTUS 120-140 HERDSMAN 80-140- 210-230-240 PALES 210-230-240	<b>Art. Kit 16054</b>  LUK	 LUK	 LUK	 LUK	 LUK	 LUK
	<b>Art. 15946</b>  LUK	OEM 6000105184 Meccanismo a 6 leve completo di disco centrale metalceramico 34x40 mm - Z12 senza disco PTO Piatto Ø 280 (11") intercambiabile con OMG	<b>Art. 15873</b>  LUK	OEM 6000105768  Disco PTO rigido in metalceramico. Ø 280 mm 22x19 mm - Z13	<b>Art. 15948</b>  LUK	OEM  Disco PTO rigido in ferodo. Ø 280 mm 22x19 mm - Z13
	<b>Art. 15280</b>  LUK	OEM  Cuscinetto reggispinta cambio 90x50x22 mm	<b>Art. LUK 15990</b>	<b>Art. 63363</b>  LUK	OEM  Cuscinetto PTO 100x65x18 mm	<b>Art. FAG 63895</b>
				<b>Art. FAG 64536</b> 	OEM  Cuscinetto volano 40x12x17 mm	





























## SAME RUOTE

CENTAUTO 55-60-65 CORSARO 70 CORSARO 70 SYNCRO	<b>Art. 15228</b> 	OEM 157.2213.3/10 Disco frizione in ferodo rigido 290x160x3,8 mm 29x23x4 mm - Z.10	<b>Art. 15438</b> 	OEM 135.2222.3/10 Disco PTO rigido in ferodo 255x155x3,5 mm 45x41EV - Z.22	
ITALIA 35 doppia frizione	<b>Art. 15223</b> 	OEM 144.2213.3/03 Disco frizione avanzamento rigido in ferodo 225x130x4,5 mm 29x23x4 mm - Z.10			
PULEDRO U - DT  (segue SAME RUOTE)	<b>Art. 15222</b> 	OEM001.6058.3 Disco PTO rigido in ferodo 262x195x4,5 mm 29x23x4 mm - Z.10			

# Frizioni e loro componenti

CLUTCHES - CLUTCH DISK - BEARING - COUPLING - LEVER - SET-REVISION

## segue SAME RUOTE

























DELFINO 32 - 35 - VIGNERON 35 - 45 doppia frizione	<b>Art. 15224</b> 	OEM 150.2213.3 - 0.008.4806.3 - 0.015.6384.3 Disco PTO rigido in ferodo 212x152x4 mm 23x18x3 mm - Z.10	<b>Art. 15918</b> 	OEM 150.2222.3 - 0.015.6383.3 Disco frizione per frizione doppia Ø 200 38x34 mm - Z.19		
AURORA 35 - 45 RANGER 45 VIGNERON 50	<b>Art. 15912</b> 	OEM 151.2222.3 0.015.6382.3 0.008.4803.3 Disco frizione rigido interno organico Ø 230 40x35 mm - Z.14	<b>Art. 15913</b> 	OEM 151.2213.3 0.014.9429.3 0.008.4804.3 Disco lato cambio esterno Ø 250 mm 25x20x4 mm - Z.10	<b>Art. 15742</b>  OEM 2.2999.034.0 0.192.6550.3 Cuscinetto reggispinta cambio - 97x55x30mm	
DORADO 55-60-65 EXPLORER 60-65/SPECIAL 70-80/SPECIAL EXPLORER II 60/ SPECIAL - 70/SPECIAL GOLDEN 60-65 SAME 65 TAURUS - 100E TIGER 105 SYNCRO	<b>Art. Kit 16038</b> 	  	OEM 0.015.9287.3  Kit composto da: - Meccanismo 15439 - Disco PTO 15979 - Cuscinetto 15744			
	<b>Art. 15439</b> 	OEM 0.015.9287.3 255.2320.3/10 0.009.6914.3/20 Meccanismo con molle a diaframma Piatto Ø 280 mm	<b>Art. 15979</b> 	OEM 0.015.9286.3  Disco frizione centrale in ferodo con molle parastrappi 280x172x3,5 mm 40x36,5EV - Z.24	<b>Art. 15440</b> 	OEM 0.015.9286.3 0.009.6913.3/10 255.2330.3/20 270.2330.3/10 Disco frizione centrale in ferodo con molle parastrappi 280x172x3,5 40x36,5EV - Z.24
					<b>Art. 15744</b>  OEM 2.2999.475.0 Cuscinetto reggispinta 90x55x22 mm	
ANTARES 110 II EXPLORER 80 II - 80SP/LP - 90 II - 90SP/LP ROW CROP 100.6 SILVER 80 - 90 - 100.4 - 100.6 - 110	<b>Art. 15954</b> 	OEM 0.010.6912.3/10 0.015.6386.3 Meccanismo con molle a diaframma Piatto Ø 350 mm	<b>Art. 15953</b> 	OEM 0.007.7929.3/10 0.015.6328.3 Disco Ø 350 mm 36,5x41 mm - Z.24	<b>Art. 15983</b> 	OEM 0.007.7930.3/10  Disco Ø 350 mm 41x45 mm - Z.21
			<b>Art. 16010</b> 	OEM 0.015.6381.3 Disco Ø 330 mm 36,5x41 mm - Z.24	<b>Art. 15744</b>  OEM 2.2999.475.0 Cuscinetto reggispinta 90x55x22 mm	
ANTARES II 130	<b>Art. Kit 16042</b> 	  	OEM  Kit composto da: - Meccanismo 15881 - Disco PTO 15882 - Cuscinetto 15883			
	<b>Art. Kit 16039</b> 	 	OEM  Kit composto da: - Meccanismo 15881 - Disco PTO 15882			
(segue SAME RUOTE)	<b>Art. 15881</b> 	OEM 008.5595.3 Meccanismo frizione con molle a diaframma Ø 350 mm	<b>Art. 15882</b> 	OEM 008.5596.3 Disco PTO Ø 350 mm - 41x45 mm Z.21	<b>Art. 15883</b>  OEM 2.2999.510.0 2.2999.207.0 2.2999.443.0 112x65x42 mm Cuscinetto reggispinta	

# Frizioni e loro componenti

CLUTCHES - CLUTCH DISK - BEARING - COUPLING - LEVER - SET-REVISION

11

## segue SAME RUOTE































<p>EXPLORER 55-60-65-70 SAME 65</p>	<p><b>Art. 15894</b>  OEM 0.015.6392.4 255.2350.3 Meccanismo frizione con diaframma Ø 280 mm</p>	<p><b>Art. 15979</b>  OEM 0.015.9286.3 Disco frizione centrale in ferodo con molle parastrappi 280x172x3,5 mm 40x36,5EV - Z.24</p>	<p><b>Art. 15440</b>  OEM 0.015.9286.3 - 0.009.6913.3/10 - 255.2330.3/20 270.2330.3/10 Disco frizione centrale in ferodo con molle parastrappi 280x172x3,5 mm 40x36,5EV - Z.24</p>	
<p>KRIPTON 100 90-100 95-105 SILVER 95-105-110</p>	<p><b>Art. Kit 16041</b>    <b>LUK</b> <b>LUK</b> <b>LUK</b></p> <p>OEM 0.012.2621.4</p> <p>Kit composto da: - Meccanismo 15923 - Disco centrale 15924 - Cuscinetto 15744</p>			
	<p><b>Art. 15923</b>  OEM 0.012.7094.3 Meccanismo frizione con molle a diaframma Ø 330 mm (13")</p>	<p><b>Art. 15924</b>  OEM 0.012.7095.3/10 Disco centrale a 5 pale 36,5x41 mm - Z.24</p>	<p><b>Art. 15744</b>  OEM 2.2999.475.0 Cuscinetto reggisplinta 90x55x22 mm</p>	
<p>ANTARES 100-110-130 EXPLORER 80 SPECIAL/SPECIAL LT EXPLORER 90LP/ SPECIAL/SPECIAL LP EXPLORER 100 LP EXPLORER II 80/80LP/ SPECIAL LP/90T LASER 170 ROW CROP 90 SILVER 80-85-90-95- 100.4-100.6-105-110- 130</p>	<p><b>Art. 15647</b>  OEM 0.008.4184.3 3713531M1 0.014.9423.3/10 Meccanismo con molle a diaframma Piatto Ø 330 mm</p>	<p><b>Art. 15964</b>  OEM 008.9937.3 Disco centrale in ferodo con molle parastrappi 330x196x4,2 mm 41x36,5EV - Z.24</p>	<p><b>Art. 15803</b>  OEM 008.9937.3 Disco centrale in ferodo con molle parastrappi 330x196x4,2 mm 41x36,5EV - Z.24</p>	
	<p><b>Art. 15965</b>  OEM 0.014.9432.3 Disco centrale metalceramico a 6 p. con molle parastrappi Ø330 mm sinterizzato 41x45,3 mm - Z.21 Per gli altri modelli</p>	<p><b>Art. 15749</b>  OEM 0.014.9432.3 Disco centrale metalceramico a 6 p. con molle parastrappi Ø330 mm sinterizzato 41x45,3 mm - Z.21 Per gli altri modelli</p>	<p><b>Art. 15895</b>  OEM 007.7928.3 Disco centrale organico con molle Ø 310 mm 41x36,5EV - Z.24 Per SILVER 80-85-90-95- 100.4-100.6- 105-110</p>	
	<p><b>Art. 15984</b>  OEM 0.016.6105.3 Disco PTO 6 pale Ø 330 mm 36x40 mm - Z.24</p>	<p><b>Art. 15673</b>  OEM 009.6533.3 Disco centrale metalceramico a 6 pale con molle parastrappi Ø 330 mm sinterizzato 41x36,5EV - Z.24 Per SILVER 100.6 e ANTARES 100</p>	<p><b>Art. 15744</b>  OEM 2.2999.475.0 Cuscinetto reggisplinta 90x55x22 mm</p>	
			<p><b>Art. 15883</b>  OEM 2.2999.510.0 2.2999.207.0 2.2999.443.0 112x65x42 mm Cuscinetto reggisplinta</p>	
<p>DORADO 70-75-85 EXPLORER 70N/SPECIAL - 75N/SPECIAL - 80 - 85 - 90 EXPLORER II 70N/SPECIAL/ SPECIAL BASSO 80/LP/SPECIAL LP/ SPECIAL BASSO 90 TURBO GOLDEN 75-85  (segue SAME RUOTE)</p>	<p><b>Art. 15420</b>  OEM 0.014.9424.3 0.008.4293.3 Meccanismo con molle a diaframma Piatto Ø 310 mm</p>	<p><b>Art. 15982</b>  OEM 0.015.9289.3 0.014.111.1.3 Disco centrale metalceramico 6 pale Ø310 mm sinterizzato 41x36 mm - Z.24</p>	<p><b>Art. 15748</b>  OEM 0.015.9289.3 0.014.1111.3 Disco centrale metalceramico 6 pale con parastrappi Ø310 mm sinterizzato 40x36,5 mm - Z.24</p>	
	<p><b>Art. 15895</b>  OEM 007.7928.3 Disco centrale metaceramico 6 pale con parastrappi Ø310 mm sinterizzato 41x36,5 mm - Z.24</p>	<p><b>Art. 15441</b>  OEM 44623.303 0.455.2330.3/10 0.015.9288.3 0.009.69.24 Disco centrale in ferodo con molle parastrappi 310x191x3,5 mm 40x36,5 mm - Z.24</p>	<p><b>Art. 15744</b>  OEM 2.2999.475.0 Cuscinetto reggisplinta 90x55x22 mm</p>	



# Frizioni e loro componenti

CLUTCHES - CLUTCH DISK - BEARING - COUPLING - LEVER - SET-REVISION

## segue SAME RUOTE

EXPLORER 80 - 90 SILVER 80-90-100.4	<b>Art. 15647</b>  LUK OEM 0.008.4184.3 0.014.9423.3 Meccanismo con molle a diaframma Piatto Ø 330 mm	<b>Art. 15964</b>  LUK OEM 008.9937.3 Disco centrale in ferodo con molle parastrappi 330x196x4,2 mm 41x36,5EV - Z.24	<b>Art. 15803</b>  OEM 008.9937.3 Disco centrale in ferodo con molle parastrappi 330x196x4,2 mm 41x36,5EV - Z.24	
	<b>Art. 15965</b>  LUK OEM 0.014.9432.3 Disco centrale metalceramico a 6 p. con molle parastrappi Ø330 sinterizzato 41x45,3 mm - Z.21	<b>Art. 15749</b>  OEM 0.014.9432.3 Disco centrale metalceramico a 6 p. con molle parastrappi Ø330 sinterizzato 41x45,3 mm - Z.21	<b>Art. 15984</b>  LUK OEM 0.016.6105.3 Disco PTO 6 pale Ø 330 36x40 - Z24	
	<b>Art. 15883</b>  OEM 2.2999.510.0 2.2999.207.0 2.2999.443.0 112x65x42 mm Cuscinetto reggispinta	<b>Art. 15744</b>  OEM 2.2999.475.0 Cuscinetto reggispinta 90x55x22 mm		
GALAXY 170 HERCULES 160 - LASER 150 TITAN	<b>Art. Kit 15394</b>  LUK  LUK  LUK OEM 212.2358.4/10 0.014.0175.4 KIT meccanismo di movimento con disco. Piatto Ø 350 mm			
	<b>Art. 15293</b>  Valeo OEM Disco centrale metalceramico a 7 pale Rigido Ø 350 mm sinterizzato 50x45EV - Z.24	<b>Art. 16043</b>  Valeo OEM 0.264.6533.3/20 Manicotto con cuscinetto 65x74x215 mm	<b>Art. 15883</b>  OEM 2.2999.510.0 2.2999.207.0 2.2999.443.0 112x65x42 mm Cuscinetto reggispinta	
TIGER SIX 105 (dal talaio 7129 in avanti) LEOPARD 90 TURBO JAGUAR 100 - LASER 90 - 100 - 110	<b>Art. Kit 15394</b>  LUK  LUK  LUK OEM 212.2358.4/10 0.014.0175.4 KIT meccanismo di movimento con disco. Piatto Ø 350 mm			
	<b>Art. 16043</b>  Valeo OEM 0.264.6533.3/20 Manicotto con cuscinetto 65x74x215 mm	<b>Art. 15445</b>  OEM 0.269.2313.3/10 Disco centrale rigido in ferodo 352x195x4,3 mm 50x45EV - Z.24	<b>Art. 15293</b>  Valeo OEM 212.2359.3/10 0.014.0176.3 Disco centrale metalcer. a 7 pale Rigido Ø 350 mm sinterizzato 50x45EV - Z.24	
DORADO70/75/80 EXPLORER 70-75-80- 85-90 EXPLORER II 70 SPECIAL/SPECIAL BASSO EXPLORER II 80/LO/ SPECIAL BASSO/ SPECIAL LP EXPLORER 90T GOLDEN 75-85	<b>Art. 15746</b>  LUK OEM 0.015.9285.3 0.008.4254.3/10 Meccanismo con molla a diaframma piatto Ø 310 mm	<b>Art. 15963</b>  LUK OEM 44623.303 0.455.2330.3/10 0.015.9288.3 Disco centrale in ferodo con molle parastrappi 310x191x3,5 mm 40x36,5 mm - Z.24	<b>Art. 15441</b>  OEM44623.303 0.455.2330.3/10 0.015.9288.3 Disco centrale in ferodo con molle parastrappi 310x191x3,5 mm 40x36,5 mm - Z.24	
	<b>Art. 15962</b>  LUK OEM 0.015.9289.3 0.014.1111.3 Disco centrale metaceramico 6 pale con parastrappi Ø310 mm sinterizzato 41x36 mm - Z.24	<b>Art. 15748</b>  OEM 0.015.9289.3 0.014.1111.3 Disco centrale metaceramico 6 pale con parastrappi Ø310 mm sinterizzato 40x36,5 mm - Z.24	<b>Art. 16011</b>  LUK OEM Disco centrale in ferodo 310x190x3,5 mm 40x36 mm - Z.24	
	<b>Art. 15744</b>  OEM 2.2999.475.0 Cuscinetto reggispinta cambio 90x55x22 mm			
JAGUAR 95-100 LEOPARD 85-90-90T	<b>Art. Kit 16107</b>  LUK  LUK  LUK OEM 0.015.6389.4 0.176.2351.4/10 KIT meccanismo con disco Ø 330 mm			



































(segue SAME RUOTE)

# Frizioni e loro componenti

CLUTCHES - CLUTCH DISK - BEARING - COUPLING - LEVER - SET-REVISION

11

## segue SAME RUOTE





















DORADO 70 - 76 - 85 - 86 - 90 - 90.4 - F70 - F75 - F90 - F100 - S70 - S75 - S90 - S100 DORADO <sup>3</sup> 70 - 80 - 90 EXPLORER 80 - 85 - 90 - 90.4 EXPLORER II EXPLORER SPECIAL EXPLORER T-TB EXPLORER <sup>3</sup> FRUTTETO S/V FRUTTETO <sup>3</sup> S/V KRYPTON VIRTUS	<b>Art. Kit 16055</b>    	OEM Kit composto da: - Meccanismo 15960 - Disco 15961 - Cuscinetto 15744	
	<b>Art. 15960</b> OEM 0.014.9017.3 Meccanismo frizione con molle a diaframma Ø 310 mm 	<b>Art. 15961</b> OEM 0.014.9016.3 0.015.2816.3 Disco Ø 310 mm 	<b>Art. 15744</b> OEM 2.2999.475.0 Cuscinetto reggispinta 90x55x22 mm 
ANTARES II 110 EXPLORER 75 - 80 SPECIAL - 85 T/TB - 90 SPECIAL - 95T/TB EXPLORER II 85 SPECIAL - 90T - 95 SPECIAL ROW CROP 90 - 100 SILVER 80 - 85 - 90 - 95 - 100.4 - 100.6 - 105 - 110	new <b>Art. Kit 16141</b>    	OEM 001661063 Kit composto da: - Meccanismo 15985 - Disco PTO 15984 - Cuscinetto 15744	
	<b>Art. 15985</b> OEM 0.016.6106.3 Meccanismo frizione con molle a diaframma Ø 350 mm 	<b>Art. 15984</b> OEM 0.016.6105.3 Disco PTO 6 pale Ø 330 mm 36x40 mm - Z24 	<b>Art. 15744</b> OEM 2.2999.475.0 Cuscinetto reggispinta 90x55x22 mm 
ASTER 60-70 - FRUTTETO II 65/75/85/90/100 ROCK 55/N/M/C - ROCK 60N/M/C/SC - ROCK 70N/M/C SOLAR 55C-60-60C - VIGNERON 62-75	<b>Art. Kit 15959</b>      	OEM Kit composto da: - Meccanismo 15745 - Disco 15917 - Cuscinetti 15990 - 63896 - 63836	
	<b>Art. 15745</b> OEM 0.012.2574.4 - 0.012.2571.4 Meccanismo 6 leve completo di disco centrale sinterizzato 40x36 - Z.20 Piatto Ø 280 mm 	<b>Art. 15917</b> OEM 0.011.9067.3 Disco Ø 280 mm 22x25 mm - 14 cave 	<b>Art. 15121</b> OEM 0.014.9428.3 Disco PTO rigido in ferodo 280x165x3,5 mm 25x22 mm - Z.14 
	<b>Art. 62549</b> OEM Cuscinetto PTO 20x47x14 mm <b>Art. FAG 63836</b> 	<b>Art. 15990</b> OEM 2.2999.153/10 Cuscinetto reggispinta cambio 90x50x22 mm 	<b>Art. 15280</b> OEM 2.2999.153/10 Cuscinetto reggispinta cambio 90x50x22 mm 
			<b>Art. 62951</b> OEM 2.2021.018.0 Cuscinetto reggispinta PTO 70x110x20 mm <b>Art. FAG 63896</b> 
ARGON 60/70/55/65F	<b>Art. 15745</b> OEM 0.012.2574.4 - 0.012.2571.4 Meccanismo 6 leve completo di disco centrale sinterizzato 40x36 - Z.20 Piatto Ø 280 mm 	<b>Art. 15917</b> OEM 0.011.9067.3 Disco Ø 280 mm 22x25 mm - 14 cave 	<b>Art. 15121</b> OEM 0.014.9428.3 Disco PTO rigido in ferodo 280x165x3,5 mm 25x22 mm - Z.14 
	<b>Art. 62549</b> OEM Cuscinetto PTO 20x47x14 mm <b>Art. FAG 63836</b> 	<b>Art. 15990</b> OEM 2.2999.153/10 Cuscinetto reggispinta cambio 90x50x22 mm 	<b>Art. 15280</b> OEM 2.2999.153/10 Cuscinetto reggispinta cambio 90x50x22 mm 
			<b>Art. 63363</b> OEM 2.2021.017.0 Cuscinetto PTO 100x65x18 mm <b>Art. FAG 63895</b> 

(segue SAME RUOTE)

# Frizioni e loro componenti

CLUTCHES - CLUTCH DISK - BEARING - COUPLING - LEVER - SET-REVISION

















































## segue SAME RUOTE

LASER 130 - 150 - LASER 165 TURBO TRIDENT 130 EXPORT	<b>Art. Kit 15394</b>   	OEM 212.2358.4/10 0.014.0175.4 KIT meccanismo di movimento con disco. Piatto Ø 350 mm	<b>Art. 15293</b>  	OEM 212.2359.3/10 Disco centrale metalceramico a 7 pale Rigido Ø 350 mm sinterizzato 50x45EV - Z.24	
	<b>Art. 15442</b>  	OEM 0.202.6551.3/20 Manicotto con cuscinetto reggispinta per TRIDENT130 e EXPORT	<b>Art. 16043</b>  	<b>Art. 15883</b>  	OEM 2.2999.510.0 2.2999.207.0 2.2999.443.0 112x65x42 mm Cuscinetto reggispinta
CENTURION 75 EXPORT MERCURY 85 EXPORT MERCURY 85 SPECIAL SATURNO 80 SYNCRO  (segue SAME RUOTE)	<b>Art. 15229</b> 	OEM 180.2213.3/10 Disco centrale in ferodo con molle parastrappi 320x203x3,8 mm 29x23x4 mm - Z.10	<b>Art. 15447</b>  	<b>Art. 15799</b> 	OEM 2.2999.003.0 Cuscinetto reggispinta 65x102x26 mm
	<b>Art. Kit 16218</b>      	ARGON 65/70/75 DORADO 50/55/65/75 DORADO NATURAL 50/55/65/70 FRUTTETO NATURAL 60/65/70/75 TREM II 60/603 TIGER 60/60E/65 /70/70E/75 TIGER COMPACT 46/ 50/55/60	OEM 9.J1424.00.9 - 0.015.4708.3/10  Kit Frizione con meccanismo a 6 leve disco e cuscinetti. Piatto Ø 280 mm.		

# Frizioni e loro componenti

CLUTCHES - CLUTCH DISK - BEARING - COUPLING - LEVER - SET-REVISION

## segue SAME RUOTE

MINITAURO 60 FRUTTETO MINITAURO 60 VIGNETO MINITAURO 60 FRUTTETO MINITAURO 60 SYNCRO CONDOR 55 CORSAFO 70 - TAURUS 60 FALCOM 50 VIGNEROM 60 - 75 FRUTTETO1 60 - 75	<b>Art. Kit 16070</b> 	 	 	OEM 0.194.2210.4/20 Kit composto da: - Meccanismo 15805 - Disco 15986			
	<b>Art. 15805</b>  	OEM 0.194.2210.4/20 Meccanismo a 6 leve completo di disco PTO senza disco centrale Ø 280 mm - Z.20	<b>Art. 15986</b>  	OEM 003.8404.3 194.2213.3/10 Disco in ferodo con molle parastrappi lato volano 280x165x3,5 mm 25x22EV - Z.14	<b>Art. 15227</b> 	OEM 003.8404.3 194.2213.3/10 Disco in ferodo con molle parastrappi lato volano 280x165x3,5 mm 25x22EV - Z.14	
		<b>Art. 15446</b> 	OEM 194.2222.3/10 Disco PTO rigido in ferodo 250x165x3,5 mm 40x36EV - Z.20	<b>Art. 15799</b> 	OEM 2.2999.003.0 Cuscinetto reggispinta 65x102x26 mm		
ARGON 55-60-65F SOLAR 60	<b>Art. 15916</b>  	OEM 0.012.2567.4 0.019.8634.4  Meccanismo a 6 leve completo di disco Ø 280 mm	<b>Art. 15917</b>  	OEM 0.011.9067.3 Disco Ø 280 mm 22x25 mm - 14 cave	<b>Art. 15990</b>  	OEM 2.2999.153/10 Cuscinetto reggispinta cambio 90x50x22 mm	
					<b>Art. 15280</b> 	OEM 2.2999.153.0/10 Cuscinetto reggispinta cambio 90x50x22 mm	
SOLAR 50 CV ARGON 50	<b>Art. Kit 16044</b> 	 	 	 	 	 	OEM 0.012.2563.4  Kit composto da: - Meccanismo 15395 - Disco PTO 15804 - Cuscinetti 15990 - 63896 - 63836
	<b>Art. 15395</b>  	OEM 463.2411.4 - 0.012.2563.4 Meccanismo a 6 leve completo di disco centrale in ferodo senza il disco PTO Piatto Ø 250 mm (11")	<b>Art. 15804</b>  	OEM 0.011.9063.3 Disco PTO rigido in ferodo 225x145x3,5 mm 25x22EV - Z.14	<b>Art. 15403</b> 	OEM 254.2222.3/10 463.2422.3 Disco PTO rigido in ferodo 250x155x3,5 mm 25x22EV - Z.14  Per vecchi modelli	
	<b>Art. 15402</b> 	OEM 254.2213.3 - 463.2413.3 Disco centrale rigido in ferodo 250x155x3,5 mm 40x36EV - Z.20	<b>Art. 15990</b>  	OEM 2.2999.153/10 Cuscinetto reggispinta cambio 90x50x22 mm	<b>Art. 15280</b> 	OEM 2.2999.153.0/10 Cuscinetto reggispinta cambio 90x50x22 mm	
			<b>Art. 62951</b>  <b>Art. FAG 63896</b>	OEM 2.2021.018.0 Cuscinetto reggispinta PTO 70x110x20 mm	<b>Art. 62549</b>  <b>Art. FAG 63836</b>	OEM Cuscinetto PTO 20x47x14 mm	
SOLARIS 30 - 35 - 40 - 45 - 50 - 55	<b>Art. Kit 15987</b> 	 	 	OEM 0.012.5851.4/20 Kit frizione doppia a 6 leve con disco interno Ø 230 mm			
	(segue SAME RUOTE)		<b>Art. 62952</b>  <b>Art. FAG 63897</b>	OEM Cuscinetto reggispinta PTO 75x115x20 mm	<b>Art. 62577</b>  <b>Art. FAG 63863</b>	OEM Cuscinetto volano 15x35x11 mm	











# Frizioni e loro componenti











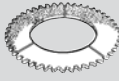



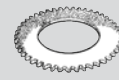
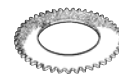

CLUTCHES - CLUTCH DISK - BEARING - COUPLING - LEVER - SET-REVISION

11

## segue SAME RUOTE

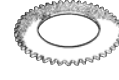
SOLARIS 250 - 350	 <b>Art. 15706</b>	OEM 0.010.0288.4 Meccanismo a 3 leve completo di disco centrale in ferodo senza il disco PTO Piatto Ø 184 mm	 <b>Art. 15707</b>	OEM Disco PTO in ferodo 184x127x3,8 mm 20x17 mm Z.12	 <b>Art. 15272</b>	OEM 0.010.8739.3 Cuscinetto reggispinta piccolo 82x50x28
					 <b>Art. 15808</b>	OEM 0.010.8738.3 Cuscinetto reggispinta grande 117x75x27
SOLARIS 350 - 450	 <b>Art. 15704</b>	OEM 0.009.6395.4/10 Meccanismo a 3 leve completo di disco centrale in ferodo senza il disco PTO Piatto Ø 215 mm	 <b>Art. 15705</b>	OEM Disco PTO rigido in ferodo 216x152x3,8 mm 20x17 mm - Z.12	 <b>Art. 15272</b>	OEM 0.010.8739.3 Cuscinetto reggispinta piccolo 82x50x28
					 <b>Art. 15808</b>	OEM 0.010.8738.3 Cuscinetto reggispinta grande 117x75x27

## SAME CINGOLI

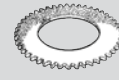
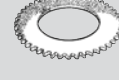
CONDOR C	 <b>Art. 15173</b>	OEM 168.2314.0 Anello per frizione centrale dentatura est. 277x156x10 mm (1/3T) 45 denti	 <b>Art. 15388</b>	OEM 160.6525.0 Anello per frizione cambio 88x48x4,5 mm 8 fori	 <b>Art. 15417</b>	OEM 434.5714.0/10 Anello per frizione di sterzo dentatura esterna 219,2x152x4,7 mm 71 denti
FALCON C	 <b>Art. 15173</b>	OEM 168.2314.0 Anello per frizione centrale - dent. esterna 277x156x10 mm (1/3T) 45 denti	 <b>Art. 15176</b>	OEM 160.5714.0/10 Anello di sterzo - in tessuto - dentatura est. 239x180x4,8 - 28 denti	 <b>Art. 15174</b>	OEM 160.5714.0/10 Anello per frizione di sterzo - in conglomerato - dentatura esterna 239x180x4,8 - 28 denti
	 <b>Art. 15389</b>	OEM 160.5715.0 Anello per frizione di sterzo - dentatura interna 229x171x2 - 21 denti	 <b>Art. 15417</b>	OEM 434.5714.0/10 Anello per frizione di sterzo - dent. esterna 219,2x152x4,7 -71 denti		
FOX 35 - 45 - 55 - LEOPARD C	 <b>Art. 15417</b>	OEM 434.5714.0/10 Anello per friz. sterzo - dentatura esterna 219,2x152x4,7 mm 71 denti				
MINITAURUS 60C - TAURUS C	 <b>Art. 15177</b>	OEM 160.2214.0 Anello per frizione centrale - dentatura est. 277x166x7 - 45 denti	 <b>Art. 15388</b>	OEM 160.6525.0 Anello per frizione cambio 88x48x4,5 mm - 8 fori	 <b>Art. 15389</b>	OEM 160.5715.0 Anello per frizione di sterzo - dentatura interna 229x171x2 - 21 denti
	 <b>Art. 15174</b>	OEM 160.5714.0/10 Anello per frizione di sterzo - in conglomerato - dentatura esterna 239x180x4,8 - 28 denti	 <b>Art. 15176</b>	OEM 160.5714.0/10 Anello di sterzo - in tessuto - dentatura esterna 239x180x4,8 - 28 denti		
SOLAR 55C COMPACT - SOLAR 60C ERGOMATIC	 <b>Art. 15397</b>	OEM 422.2261.3 Disco frizione centrale rigido in ferodo 280x165x3,8 mm 40x36EV - Z.20	 <b>Art. 15121</b>	OEM 422.2222.3/20 Disco PTO rigido in ferodo 280x165x3,5 mm 25x22EV - Z.14	 <b>Art. 15389</b>	OEM 160.5715.0 Anello per frizione di sterzo - dentatura interna 229x171x2 - 21 denti
	 <b>Art. 15176</b>	OEM 160.5714.0/10 Anello di sterzo - in tessuto - dentatura esterna 239x180x4,8 - 28 denti	 <b>Art. 15174</b>	OEM 160.5714.0/10 Anello per frizione di sterzo - in conglomerato - dentatura esterna 239x180x4,8 - 28 denti		

# Frizioni e loro componenti

CLUTCHES - CLUTCH DISK - BEARING - COUPLING - LEVER - SET-REVISION

## SEP

































MOTOFALCIATRICE 150 - 200	<b>Art. 15019</b> 	OEM Disco frizione rigido 110x58x1,5 mm 15x12EV - Z.8		
MOTOZAPPA 140	<b>Art. 15608</b> 	OEM Disco frizione rigido 122x80x11,5 mm 28x25EV - Z.15		
MOTOCOLTIVATORI MOTOZAPPE	<b>Art. 15736</b> 	OEM 210962 Disco frizione rigido 82x58x2 mm 28x25EV - Z.15		
MOTOCOLTIVATORE 125	<b>Art. 15737</b> 	OEM 220534 Frizione Ø 100x88 a dischi multipli con 4 dischi Albero 23 mm Conicità 1:5 15x12 - Z.8	<b>Art. 15630</b> 	OEM Disco frizione sinterizzato Ø 93 mm
MOTOCOLTIVATORE 1700	<b>Art. 15743</b> 	OEM 220585 Frizione Ø 103x122 a dischi multipli con 4 dischi. Albero 23 mm Conicità 1:5 15x12 mm - Z.8		
MOTOCOLTIVATORE REVERSIBILE 1000	<b>Art. 15853</b> 	OEM Frizione Ø 100x108 mm a 4 dischi 12x15EV - Z.8 Albero Ø 23 mm	<b>Art. 15630</b> 	OEM Disco frizione sinterizzato Ø 93 mm
MOTOCOLTIVATORE 1700 (motore Robin)	<b>Art. 15854</b> 	OEM Frizione Ø 103x102 mm a 4 dischi 12x15EV - Z.8 Albero Ø 23 mm		
MOTOCOLTIVATORE 1900	<b>Art. 15856</b> 	OEM Frizione Ø 103x107 mm a 4 dischi 12x15EV - Z.8 Albero Ø 24 mm		
MOTOCOLTIVATORE (motore HONDA)	<b>Art. 15857</b> 	OEM 220541 Frizione Ø 100x117 mm a 3 dischi 12x15EV - Z.8 Albero Ø 19,05 mm		
MOTOZAPPA 138 CL	<b>Art. 15858</b> 	OEM Frizione monodisco Ø 142x105 mm 13x16 mm - Z.6 Albero Ø 24 mm		
MOTOZAPPA S 130-132	<b>Art. 15859</b> 	OEM Frizione monodisco Ø 142x87 mm 13x16 mm - Z.6 Albero Ø 23 mm		
MOTOZAPPA S 140	<b>Art. 15860</b> 	OEM Frizione monodisco Ø 142x121 mm 13x16 mm - Z.6 Albero Ø 24 mm		

# Frizioni e loro componenti

CLUTCHES - CLUTCH DISK - BEARING - COUPLING - LEVER - SET-REVISION

11













## STEYR

4065 4075	<b>Art. Kit 16073</b>     	OEM 47134886	Kit composto da: - Meccanismo 15797 - Disco PTO 15792 - Cuscinetti 63897 - 63867
<b>Art. 15797</b>  	<b>Art. 15792</b>  	<b>Art. 62581</b>  <b>Art. FAG 63867</b> OEM 28043280 Cuscinetto volano 17x47x14 mm	
		<b>Art. 62952</b>  <b>Art. FAG 63897</b> OEM 47127081 Cuscinetto reggispinta PTO 75x115x20 mm	
KOMPAKT 370/375/ 485/495/4065/4075/ 4085/4095	<b>Art. Kit 16036</b>      	OEM	Kit composto da: - Meccanismo 15796 - Disco PTO 15792 - Cuscinetti 15990 - 63897 - 63867
<b>Art. Kit 15930</b>   	OEM	Kit composto da: - Meccanismo 15796 - Disco PTO 15792	
<b>Art. 15796</b>  	<b>Art. 15990</b>  	<b>Art. 15280</b>  OEM 5122028 87345759 Cuscinetto reggispinta cambio 90x50x22 mm	
<b>Art. 15792</b>  	<b>Art. 62952</b>  <b>Art. FAG 63897</b>	<b>Art. 62581</b>  <b>Art. FAG 63867</b> OEM 28043280 Cuscinetto volano 17x47x14 mm	
9155	<b>Art. Kit 15904</b>   	OEM 49700160901	Meccanismo bi-disco Ø 310 mm

# Frizioni e loro componenti

CLUTCHES - CLUTCH DISK - BEARING - COUPLING - LEVER - SET-REVISION

## STEYR

<p>KOMPAKT 360</p>	<p><b>Art. Kit 16035</b></p>   <p>OEM 73328271</p> <p>Kit composto da:          - Meccanismo 15793          - Disco PTO 15792          - Cuscinetti 15990 - 63897 - 63867</p>		
<p><b>Art. 15793</b></p>   <p>OEM 5196818-47134898          Meccanismo a 6 leve completo di disco centrale cerametallico 5 pale          Piatto Ø 280 mm</p>	<p><b>Art. 15792</b></p>   <p>OEM 5176450 - 47134874 - 5196819          Disco PTO rigido in cerametallico 4 pale          Ø 280 mm - 22x25 Z10</p>	<p><b>Art. 15990</b></p>   <p>OEM 5119290 5119875 - 5122028          Cuscinetto reggispinta cambio 90x50x22 mm</p>	
	<p><b>Art. 62952</b></p>   <p>OEM 47127081          Cuscinetto reggispinta PTO          75x115x20 mm</p> <p><b>Art. FAG 63897</b></p>	<p><b>Art. 62581</b></p>   <p>OEM 28043280          Cuscinetto volano 17x47x14 mm</p> <p><b>Art. FAG 63867</b></p>	



# Frizioni e loro componenti

CLUTCHES - CLUTCH DISK - BEARING - COUPLING - LEVER - SET-REVISION

## UNIVERSAL / UTB

453  
703  
704  
723  
853

**Art. Kit  
15929**



OEM

Kit composto da:  
- Meccanismo 15505  
- Disco PTO 15943

## MECCANISMO RINFORZATO

N.B.: Quando si sostituisce un meccanismo non rinforzato con un meccanismo rinforzato, bisogna sostituire anche il disco PTO.

**Art. Kit  
15938**



OEM

Kit composto da:  
- Meccanismo 15505  
- Disco PTO 15943  
- Cuscinetti 15990 - 63896 - 63867

**Art. 15505**



OEM 5162900-5150652  
Meccanismo a 6 leve completo di disco centrale metalceramico a 6 pale senza il disco PTO. Piatto Ø 280 mm (11") Intercambiabile con meccanismo VALEO

**Art. 15943**



OEM 5145715 - 5154703  
Disco PTO rigido in ferodo 280x165x3 mm 25x22EV - Z.10

**Art. 15520**



OEM 5145715 - 5154703  
Disco PTO rigido in ferodo 280x165x3 mm 25x22EV - Z.10

**Art. 15414**



OEM 5145711  
Disco centrale metalceramico a 5 pale con molle parastrappi Ø 280 mm sinterizzato 40x35EV - Z.14

**Art. 15528**



OEM 5162901  
Disco centrale metalceramico a 6 pale con molle parastrappi per meccanismo 15505 Ø 280 mm sinterizzato 40x35EV - Z.14

**Art. 15523**



OEM 5156209  
Disco centrale in ferodo con molle parastrappi 280x165x3,5 mm 40x35EV - Z.14

### Tipo SILA intercambiabile con LUK

**Art. 15990**



OEM 5119290 5119875 - 5122028  
Cuscinetto reggispinta cambio 90x50x22 mm

**Art. 15280**



OEM 5119290 5119875 - 5122028  
Cuscinetto reggispinta cambio 90x50x22 mm

**Art. 62581**

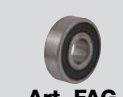

OEM 28043280  
Cuscinetto volano 17x47x14 mm

**Art. 15863**



OEM 599930  
Cuscinetto reggispinta

**Art. 15800**



Nuova Versione OEM 5197980

**Art. FAG  
63867**

**Art. 62951**



OEM 24905360  
Cuscinetto reggispinta PTO 70x110x20 mm

**Art. 15862**



OEM 5103178  
Cuscinetto reggispinta

**Art. 15751**



OEM 26794570  
Cuscinetto PTO 65x100x11 mm  
Per mod: 480S-500S-540S-550-600-640

## URSUS

8054 - 8064STD  
9054  
C380M - C382 - C392

**Art. Kit  
16095**



OEM

Kit frizione con disco PTO rigido Ø 310 mm Z.13

10014H - 8014H - 9014H

**Art. Kit  
16092**























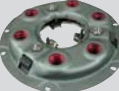

OEM 82224600 - 82224610  
Kit frizione completo Ø 300/280 con disco PTO rigido Ø 280 mm Z.18 e cuscinetti:  
55x92,4x50 - 70x132,4x93,4 - 20x52x15

# Frizioni e loro componenti

CLUTCHES - CLUTCH DISK - BEARING - COUPLING - LEVER - SET-REVISION

11

## VALPADANA

MOTOCOLTIVATORI: VMC 14	<b>Art. 15016</b>  OEM 104333 Frizione monodisco a molle elicoidali Piatto Ø 155 mm	<b>Art. 15033</b>  OEM 104337 Disco frizione rigido in ferodo 155x114x4,5 17x14x4 mm- Z.6	<b>Art. 15059</b>  OEM 104340 Leva a forcella
	<b>Art. 15051</b>  OEM 104338 Cuscinetto reggispinta	<b>Art. 15048</b>  OEM 104334 Manicotto	
MOTOCOLTIVATORI 140	<b>Art. 15608</b>  OEM Disco frizione rigido 122x80x11,5 mm 28x25EV - Z.15		
MOTOFALCIATRICE SUPER VALPADANA	<b>Art. 15194</b>  OEM Disco frizione rigido 178x134x2,5 mm 26x21x3 mm Z.10		
MOTOCOLTIVATORI: PADANO D12 - D14 - VMC 18 - TRATTORINI: 4RM20	<b>Art. 15006</b>  OEM 102776 Frizione monodisco a molle elicoidali Piatto Ø 187 mm	<b>Art. 15038</b>  OEM 102770 Disco frizione rigido in ferodo 184x127x3,8 22x18x3,5 mm - Z.10	<b>Art. 15069</b>  OEM 104068 Leva a forcella
	<b>Art. 15052</b>  OEM 102772 Cuscinetto reggispinta 68x36x19 mm	<b>Art. 15047</b>  OEM 102773 Manicotto	
TRATTORINI: 4RM 350 - 4RM 450 4RM 555	<b>Art. 15009</b>  OEM 104952 Frizione monodisco a molle elicoidali Piatto Ø 215 mm	<b>Art. 15027</b>  OEM 104951 Disco frizione rigido in ferodo 216x152x3,5 22x18x3,5 mm - Z.10	<b>Art. 15069</b>  OEM 104956 Leva a forcella
	<b>Art. 15052</b>  OEM 104953 Cuscinetto reggispinta 68x36x19 mm	<b>Art. 15047</b>  OEM 104954 Manicotto	
MOTOCOLTIVATORI: VMC 160 - VMC 12	<b>Art. 15002</b>  OEM 109081 Meccanismo monodisco con molle a diaframma Piatto Ø 110 mm	<b>Art. 15019</b>  OEM 108783 Disco frizione rigido 110x58x1,5 mm 15x12EV - Z.8	<b>Art. 15057</b>  OEM Leva a forcella
	<b>Art. 15050</b>  OEM Cuscinetto reggispinta	<b>Art. 15042</b>  OEM Manicotto con cuscinetto reggispinta	

# Frizioni e loro componenti

CLUTCHES - CLUTCH DISK - BEARING - COUPLING - LEVER - SET-REVISION

## segue VALPADANA

TRATTORI: 4RM 6000 - 6060 (doppia frizione)	<b>Art. 15390</b>	OEM 116597 Frizione doppia a comandi separati con disco centrale. Senza disco PTO Piatto Ø 215 mm		<b>Art. 15098</b>	OEM 109917 - 117426 Disco frizione centrale rigido in ferodo 216x152x3,9 mm 35x31EV - Z.18		<b>Art. 15233</b>	OEM 117169 Disco PTO rigido in ferodo 216x152x3,9 mm 20x17EV - Z.12	
	<b>Art. 16151</b>	OEM Disco PTO rigido in ferodo 216x152x3,9 mm 18x15 - Z.10		<b>Art. 15268</b>	OEM 109955 Leva a forcella		<b>Art. 15807</b>	OEM Cuscinetto reggispinga cambio 82x50x26	
	<b>Art. 15808</b>	OEM Cuscinetto reggispinga PTO 117x75x27							
MOTOCOLTIVATORE	<b>Art. 15737</b>	OEM 220534 Frizione Ø 100x88 mm a dischi multipli con 4 dischi		Albero 23 mm Conicità 1:5 15x12 mm - Z.8	<b>Art. 15743</b>	OEM 220585 Frizione Ø 100x122 mm a dischi multipli		Albero 23 mm Conicità 1:5 15x12 mm - Z.8	
1555	<b>Art. Kit 16203</b>	 <b>LUK</b>	 <b>LUK</b>	OEM 6510439M91 Kit composto da: - Meccanismo - Disco PTO 15907					

## VALTRA / VALMET

MEGA 8300 MEGA 8800	<b>Art. Kit 15904</b>	 <b>LUK</b>	 <b>LUK</b>	OEM Meccanismo bi-disco Ø 310 mm				
255 - 305 - 355 - 365 405 - 415 - 455 - 465 555 - 565 - 600 - 665 700 - 800 - 865 - 900 A65 - A75 - A85 - A95 - A72/92 Classic BL77/88	<b>Art. Kit 16092</b>	 <b>LUK</b>	 <b>LUK</b>	 <b>LUK</b>	 <b>LUK</b>	 <b>LUK</b>	OEM 82224600 - 82224610 Kit frizione completo Ø 300/280 con disco PTO rigido Ø 280 mm Z.18 mozzo 22x21 Z.18 e disco interno mozzo con 44x40 Z.22 e cuscinetti: 55x92,4x50 - 70x132,4x93,4 - 20x52x15	
MEZZO 6000/6100/6200/ 6300/6400/6600/ 6800/6900/8000/ 8100	<b>Art. Kit 16093</b>	 <b>LUK</b>	 <b>LUK</b>	 <b>LUK</b>	 <b>LUK</b>	OEM 35652000 Kit frizione completo Ø 330 con disco Ø 330 mm Z.22 e cuscinetti: 60x97x26 - 40x68x15		

# Frizioni e loro componenti

CLUTCHES - CLUTCH DISK - BEARING - COUPLING - LEVER - SET-REVISION

11

## YTO

X700  
X704  
X800  
X804  
X904

### MECCANISMO RINFORZATO

N.B.: Quando si sostituisce un meccanismo non rinforzato con un meccanismo rinforzato, bisogna sostituire anche il disco PTO.

**Art. Kit 15929**



OEM

Kit composto da:  
- Meccanismo 15505  
- Disco PTO 15943

**Art. Kit 15938**



OEM

Kit composto da:  
- Meccanismo 15505  
- Disco PTO 15943  
- Cuscinetti 15990 - 63896 - 63867

**Art. 15505**



OEM 5162900-5150652  
Meccanismo a 6 leve completo di disco centrale metalceramico a 6 pale senza il disco PTO. Piatto Ø 280 mm (11") Intercambiabile con meccanismo VALEO

**Art. 15943**



OEM 5145715 - 5154703  
Disco PTO rigido in ferodo 280x165x3 mm 25x22EV - Z.10

**Art. 15520**



OEM 5145715 - 5154703  
Disco PTO rigido in ferodo 280x165x3 mm 25x22EV - Z.10

**Art. 15414**



OEM 5145711  
Disco centrale metalceramico a 5 pale con molle parastrappi Ø 280 mm sinterizzato 40x35EV - Z.14

**Art. 15528**



OEM 5162901  
Disco centrale metalceramico a 6 pale con molle parastrappi per meccanismo 15505 Ø 280 mm sinterizzato 40x35EV - Z.14

**Art. 15523**

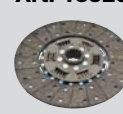

OEM 5156209  
Disco centrale in ferodo con molle parastrappi 280x165x3,5 mm 40x35EV - Z.14

Tipo SILA intercambiabile con LUK

**Art. 15990**



OEM 5119290 5119875 - 5122028  
Cuscinetto reggispinta cambio 90x50x22 mm

**Art. 15280**



OEM 5119290 5119875 - 5122028  
Cuscinetto reggispinta cambio 90x50x22 mm

**Art. 62581**



OEM 28043280  
Cuscinetto volano 17x47x14 mm



**Art. 15800**

Nuova Versione OEM 5197980

**Art. FAG 63867**

**Art. 15863**



OEM 599930  
Cuscinetto reggispinta

**Art. 62951**



OEM 24905360  
Cuscinetto reggispinta PTO 70x110x20 mm

**Art. FAG 63896**

**Art. 15862**



OEM 5103178  
Cuscinetto reggispinta

**Art. 15751**



OEM 26794570  
Cuscinetto PTO 16013 65x100x11 mm  
Per mod: 480S-500S-540S-550-600-640

X1204

### MECCANISMO RINFORZATO

N.B.: Quando si sostituisce un meccanismo non rinforzato con un meccanismo rinforzato, bisogna sostituire anche il disco PTO.

**Art. Kit 15932**



OEM

Kit frizione doppia a 6 leve con disco interno e disco PTO Ø 310 mm



# Frizioni e loro componenti

CLUTCHES - CLUTCH DISK - BEARING - COUPLING - LEVER - SET-REVISION

## ZETOR

3011 - 3045 - 3511  
- 3545 - 4712 - 4718  
- 4911 - 5011

**Art. Kit  
16086**

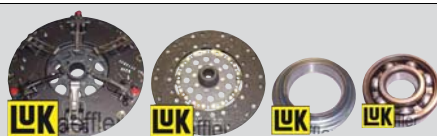

OEM 72010011  
Kit frizione completo Ø 280 con disco PTO  
rigido Ø 280 mm Z.16 e cuscinetti:  
65x101x22,5 - 20x52x15

3320 - 3340 - 4320  
- 5011 - 5211 - 5213  
- 5243 - 5245 - 5511  
- 5545 - 5320 - 5340/  
Horal - 5545 - 5611  
- 5645 - 5647 - 5745  
- 5748 - 5711 - 5718  
- 5945 - 6011 - 5911  
- 6245 - 6320 - 6340  
- 6045 - 6211 - 6718  
- 6745 - 6340E -  
6711 - 6911 - 6945  
- 6748 - 7211 - 7245  
- 7011 - 7045 - 7711  
- 7320 - 7340 - 7745

**Art. Kit  
16087**



OEM 54021902  
Kit frizione completo Ø 310 con disco PTO  
rigido Ø 310 mm Z.18 e cuscinetti:  
65x101x22,5 - 20x52x15

MAJOR 3320/5320/  
5340/6000/3340/  
4320/4340/6340/  
7320/7340  
PROXIMA 6421/6441/  
7421/7441/8421/ 8441  
SUPER 3321/3341/  
4321/4341/5321/5341/  
6321E/6341E/7321/  
7341  
ANTAR 6421/6441/  
7421/7441/8421/  
8441  
PROXIMA 65/70/75/  
80/85/90/95  
PROXIMA CABRIO  
100/65/70/75/80/85/  
90/95

**Art. Kit  
16090**



OEM 54021902  
Kit frizione completo Ø 310 con disco PTO a 6  
pale Ø 310 mm Z.18 e cuscinetti:  
65x101x22,5 - 20x52x15

5211 - 5213 - 5243  
- 5245 - 5511 - 5545  
- 5611 - 5645 - 5647  
- 5711 - 5718 - 5745  
- 5748 - 5911 - 6011  
- 6045 - 6211 - 6245  
- 6711 - 6718 - 6745  
- 6748 - 6911 - 6945  
- 7011 - 7045 - 7211  
- 7245 - 7711 - 7745

**Art. Kit  
16089**



OEM 72010011  
Kit frizione completo Ø 280 con disco PTO a 6  
pale Ø 280 mm Z.18 e cuscinetti:  
65x101x22,5 - 20x52x15

FORTERRA 10641/  
10741/11441/11641/  
11741/12441/8621/  
8641/9621/9641/  
9741

**Art. Kit  
16091**



OEM 938315  
Kit frizione meccanismo Ø 330 mm più disco  
rigido Ø 327 mm Z.18

# Frizioni e loro componenti

CLUTCHES - CLUTCH DISK - BEARING - COUPLING - LEVER - SET-REVISION

## RIEPILOGO CUSCINETTI E MANICOTTI PER FRIZIONI

RÉSUMÉ DE ROULEMENTS Y MANCHONS POUR EMBRAYAGES - SUMMARY OF BEARINGS AND CONNECTIONS FOR CLUTCHES - ZUSAMMENFASSUNF KUPPLUNGSLAGER & HUELSEN - RESUMEN DE COJINETES Y SEPARADORES PARA EMBRAYAGES

ARTICOLO	DESCRIZIONE	MISURE	ARTICOLO	DESCRIZIONE	MISURE
15042	Manicotto con cuscinetto reggispinta		15410	Manicotto con cuscinetto reggispinta	
15043	Manicotto con cuscinetto reggispinta		15442	Manicotto con cuscinetto reggispinta	
15047	Manicotto		15514	Cuscinetto reggispinta	
15050	Cuscinetto reggispinta		15629	Manicotto con cuscinetto reggispinta	
15051	Cuscinetto reggispinta		15660	Manicotto con cuscinetto reggispinta	
15052	Cuscinetto reggispinta		15669	Cuscinetto reggispinta	
15054	Cuscinetto reggispinta		15740	Manicotto con cuscinetto reggispinta	
15055	Cuscinetto reggispinta		15742	Cuscinetto reggispinta cambio	
15272	Cuscinetto reggispinta		15744	Cuscinetto reggispinta cambio	
15280	Cuscinetto reggispinta cambio		15751	Cuscinetto PTO	
15302	Manicotto con cuscinetto reggispinta		15752	Cuscinetto reggispinta PTO	
15332	Manicotto con cuscinetto reggispinta		15753	Cuscinetto con manicotto	
15365	Cuscinetto reggispinta				
15404	Cuscinetto reggispinta				

# Frizioni e loro componenti

CLUTCHES - CLUTCH DISK - BEARING - COUPLING - LEVER - SET-REVISION

## segue RIEPILOGO CUSCINETTI E MANICOTTI PER FRIZIONI

RÉSUMÉ DE ROULEMENTS Y MANCHONS POUR EMBRAYAGES - SUMMARY OF BEARINGS AND CONNECTIONS FOR CLUTCHES - ZUSAMMENFASSUNF KUPPLUNGSLAGER & HUELSEN - RESUMEN DE COJINETES Y SEPARADORES PARA EMBRAGUES

ARTICOLO	DESCRIZIONE	MISURE	ARTICOLO	DESCRIZIONE	MISURE
15754	Manicotto con cuscinetto reggispinta		15900	Collare con cuscinetto	
15755	Cuscinetto reggispinta		15936	Cuscinetto	
15756	Cuscinetto reggispinta PTO		15980	Cuscinetto reggispinta	
15758	Manicotto con cuscinetto reggispinta		15990	Cuscinetto reggispinta cambio	
15800	Cuscinetto reggispinta cambio		16043	Manicotto con cuscinetto	
15807	Cuscinetto reggispinta cambio		16046	Manicotto con cuscinetto reggispinta	
15808	Cuscinetto reggispinta PTO		16051	Cuscinetto reggispinta	
15861	Cuscinetto reggispinta		16052	Cuscinetto reggispinta	
15862	Cuscinetto reggispinta		16053	Cuscinetto	
15863	Cuscinetto reggispinta				
15864	Cuscinetto reggispinta				
15866	Manicotto con cuscinetto reggispinta				
15883	Cuscinetto reggispinta				

























# Parastrappi

## DAMPER

11









MARCA E MODELLO	ARTICOLO	DISEGNO	OEM E MISURE	MARCA E MODELLO	ARTICOLO	DISEGNO	OEM E MISURE
<b>AGROMECHANIKA</b>				<b>DEUTZ</b>			
AGT 850T	16080		OEM Ø 225 mm 22x25 mm Z.14	AGRIFARM 85/ 100/ 410/T/TB/ 420/T/TB/ 430 AGROPLUS 67/ 70/S/F/75S/77/87/ 90S/F/100/S/F/ 310/315/320/F/V/ 330/V/410/F/V/420/V/ 430/F 67.70/75/77/87/90 F70/75/90/100	16020		OEM 0011563760 Ø 328 mm Z.21
<b>BCS - FERRARI</b>							
COBRAM 40/AR/RS - COBRAM 50L/AR/RS - VALIANT 400/AR/RS - VALIANT 500L/AR/RS - SYSTEM 50L/AR/RS -	16080		OEM 58173493 Ø 225 mm 22x25 mm Z.14	AGROTRON 80/ 85/90/100/105/ 110 4.70/80/85/90/95 6.01 K100/110/120/90/ 410/420/430/610 K Profiline 100/ 110/120/90/420/ 430/610 MK3 100/105/80/ 85/90	16019		OEM 044.5502.9 Ø 264 mm 31x35 mm Z.16
MARS - ORION - SYSTEM 75/AR/MT/RS - SYSTEM 85/AR/MT/RS - THOR - VANGUARD 750/AR/ RS - VANGUARD 800/AR/ RS - VEGA - VITHAR - VOLCAN	16081		OEM 58177653 Ø 225 mm 27x30 mm Z.16	AGROPLUS 75/ 85/95/100/	16014		OEM 0.011.3942.4 Ø 263 mm 46x50 mm Z.24
<b>CASE</b>							
JXU 75/85/95/105 JX 1070U / 1080U / 1090U / 1100U	16013		OEM 87527552 Ø 262 mm 35x40 mm Z.14	AGROTRON 195/ 200/ L710/L720/L730	16025		OEM 0.013.8769.4/20 Ø 328 mm 50x55 mm Z.26
JXU115 MAXXUM 100/110/115/ 125 MXU 100/110/115/130	16021		OEM 5196061 Ø 262 mm 31x35 mm Z.16	AGROTRON 195/ 200/160MK3/ 175MK3/200MK3	16017		OEM Ø 320 mm 50x55 mm Z.26
MXM 120/130/140/155/ 175/190/ PUMA 115/125/130/ 140/155/160/165/180/ 195/210/150CVX/ 165CVX/175CVX	16023		OEM 87542609 - 87302871 Ø 348 mm 35x40 mm Z.14	<b>FORD</b>			
JXU75 - JXU85 - JXU95 - JXU105 - JXU115	16024		OEM 84389461 47554840 Ø 320 mm 35x40 mm - Z.14	8160 - 8260 - 8360 - 8560	16016		OEM 87304267 Ø 348 mm 35x40 mm Z.14
MAXXUM 100/110/120/130	16027		OEM 87527558 Ø 395 mm 31x35 mm Z.16	<b>HURLIMANN</b>			
MXM 120/130/140/155/165	16016		OEM 87304267 Ø 348 mm 35x40 mm Z.14	XA 60/66/70/76/ 80/86/90/100 XB 85/90/100/105 XF 70/75/80/90 XS 70/100/110/ 75/90 XV 80/90/100	16020		OEM 0.014.4020.4/10 Ø 328 mm Z.21
<b>CLAAS</b>							
-	16020		OEM 0011563760 Ø 328 mm Z.21	XM 100/110/115/ 120/125	16019		OEM 044.5502.9 Ø 264 mm 31x35 mm Z.16
				<b>LAMBORGHINI</b>			
				R3 EVO RF 70/75/90/100 RS 70/75/90 RV 70/75/99/100	16020		OEM 0.014.4020.4/10 Ø 328 mm Z.21
				R. 6100/6110/6120	16019		OEM 044.5502.9 Ø 264 mm 31x35 mm Z.16

MARCA E MODELLO	ARTICOLO	DISEGNO	OEM E MISURE
<b>LANDINI</b>			
MYTHOS REX CAB REX TIER 2 / 3 REX TOP RESTYLING SERIE 4 VISION	<b>16195</b>		OEM 3648843M91 Ø 263 mm 31x35 mm Z.16
LANDPOWER LEGEND LEGEND N-G LEGEND N-G. TDI SERIE 6L TIER 4	<b>16196</b>		OEM 3652970M91 Ø 294 mm 50,4X 54,6 mm Z.26

### MASSEY FERGUSON

5425/5435/5445/ 5455/5460/6235/ 6245/6255/6265/ 6445/6455/6460/ 6470	<b>16028</b>		OEM 3792448H2 Ø 294 mm 39x42,5 mm Z.26
---	--------------	---	---







### NEW HOLLAND

T5030-T5040- T5050-T5060 TL70A-TL80A-TL90A- TL100A	<b>16013</b>		OEM 87527552 Ø 262 mm 35x40 mm Z.14
5640-6640-7740-7840- 8240-8340 TS90-TS100-TS110- TS115	<b>16015</b>		OEM 82008857 Ø 262 mm 28,7x35,2 mm Z.10
TM 120/130/140/150/ 155 M 100/115/135/160	<b>16016</b>		OEM 5187845 Ø 348 mm 35x40 mm Z.14
4635-6635-7635-4835- 5635 L60-L65-L75-L85-L95 TL65-TL70-TL80-TL90- TL100	<b>16018</b>		OEM 5181872 Ø 116 mm 22x15 mm Z.10
T5030 - T5040 - T5050 - T5060 - TL100 - TL100A - TL70 - TL70A - TL80 - TL80A - TL90 - TL90A - L60 - L65 - L75 - L85 - L85 - L95 - 4635 - 4835 - 5635 - 6635 - 7635	<b>16076</b>		OEM 47133433 Ø 136 mm
T5030-T5040-T5050- T5060-T5070	<b>16024</b>		OEM 84389461 47554840 Ø 320 mm 35x40 mm - Z.14
T5070-T6010-T6020- T6030-T6050 TS100A-TS110A- TS115A-TS130A	<b>16021</b>		OEM 5196061 Ø 262 mm 31x35 mm Z.16
TM115-TM125- TM135-TM150-TM165	<b>16022</b>		OEM 5185207 Ø 348 mm 35x40 mm Z.14

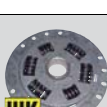

### segue NEW HOLLAND

TM 120/130/140/155/ 175/190 T 6030/6050/6070/ 6080/6090/6095/7030/ 7040/7050/7060 T7. 130/185/200/210/ 225/165/175/	<b>16023</b>		OEM 87542609 - 87302871 Ø 348 mm 35x40 mm Z.14
T 6010/6020/6040/6060	<b>16027</b>		OEM 87527558 Ø 395 mm 31x35 mm Z.16

### SAME

HUERL FASTDRIVE XT 908 EXPLORER 85-95 SILVER 80-85-90-95- 100.4-100.6-105-110	<b>16014</b>		OEM 0.011.3942.4 Ø 263 mm 46x50 mm Z.24
IRON 175S-190S-200 RUBIN 120-135-150-160-180- 200 SILVER 160-180 TITAN SUPERTITAN -145-150-160-165-190	<b>16017</b>		OEM 0.014.9430.3 Ø 320 mm 50x55 mm Z.26
DZ LAMB SA IRON 100/110/120	<b>16019</b>		OEM 044.5502.9 Ø 264 mm 31x35 mm Z.16
AUDAX 200-220 IRON 175S-190S-200 IRON TIER3 210-190DCR-210DCR- 220DCR SILVER 110-115-130	<b>16025</b>		OEM 0.013.8769.4/20 Ø 328 mm 50x55 mm Z.26
SILVER 80-90-100.4- 100.6	<b>16026</b>		OEM 010.0231.4/30 Ø 263 mm 46x50 mm Z.24
DORADO 66/76/86 DORADO3 60/70/ 80/90/100 EXPLORER3 80/ 85/90/100/110 F 70/75/90/100 S 70/75 V 70/75/90	<b>16020</b>		OEM 0.014.4020.4/10 Ø 328 mm Z.21

### VALTRA

N HI TECH 101/ 111e/121/141/91 T 120/130/140ec/ 160/170/180/190 T DIRECT 153/ 163e/183/203 T VERSU 153/ 163e/182/183/213 N 101/111e/	<b>16109</b>		OEM 35303500 - 35652400 Ø 352 mm Z.22
C 100/110/120/e.p./ 130/150/90 M 100/110/120/e.p./ 130/150 XM130 -	<b>16110</b>		OEM 35652300 Ø 352 mm Z.22

# Pompe e Cilindri freno e frizione

## CLUTCH CYLINDERS, CLUTCH PUMPS AND BRAKE PUMPS

11

### POMPE FRENO

POMPE DE FREIN - BRAKE-PUMP - BREMSENPUMPE - BOMBA DE FRENO



**OLIO DOT 4**

ARTICOLO	APPLICAZIONI	OEM
<b>16102</b>	Serie 80 (fino al 30/01/1997)	<b>LANDINI:</b> 3536279M92 3303732M92

new



**OLIO DOT 4**

ARTICOLO	APPLICAZIONI	OEM
<b>16133</b>	6550, 7550, 8550, serie 80, serie large 10000, 12500, 13000, 14500	<b>LANDINI:</b> 3305623M92



**OLIO DOT 4**

ARTICOLO	OEM
<b>16101</b>	<b>LANDINI:</b> 1874957M91 <b>MASSEY FERGUSON:</b> 1698670M91



**OLIO MINERALE**

ARTICOLO	APPLICAZIONI	OEM
<b>16058</b>	Buffalo - Centauro 70 - Centurion 75 - Hercules 160 - Jaguar 95/100 - Leopard 85/90 - Mercury 85 - Tiger - Trident	<b>LANDINI:</b> 3301382M93 <b>SAME:</b> 0.169.6665.4/20



**OLIO MINERALE**

ARTICOLO	APPLICAZIONI	OEM
<b>16059</b>	Antares - Argon - Dorado - Explorer - Frutteto - Golden - Roller - Silver	<b>LANDINI:</b> 3537810M91 <b>SAME:</b> 0.009.9234.4/10 <b>JD:</b> ER374066 <b>CNH:</b> 87398198



**OLIO MINERALE**

ARTICOLO	APPLICAZIONI	OEM
<b>16103</b>	-	<b>LANDINI:</b> 3666220M92 <b>CNH:</b> 84558759 - 87343615



**OLIO MINERALE**

ARTICOLO	APPLICAZIONI	OEM
<b>16060</b>	<b>CNH:</b> Serie TN - TNA - TNVA - TNNA <b>SAME:</b> Antares - Explorer - Row Crop	<b>CNH:</b> 5179371 87354675 <b>SAME:</b> 0.255.6638.4/60 0.257.6538.4/10



**OLIO MINERALE**

ARTICOLO	OEM
<b>16096</b>	<b>CNH:</b> 5145630 - 5177993 - 87354670 <b>CARRARO ANTONIO:</b> 43309022 <b>SAME:</b> 0.257.6638.4/10

new



**OLIO MINERALE**

ARTICOLO	APPLICAZIONI	OEM
<b>16211</b>	<b>LAMBORGHINI:</b> Formula - Premium - R4 - RS <sup>3</sup> <b>SAME:</b> Antares - Laser - Silver <b>DEUTZ:</b> Agrotrac	0.008.2190.4/30

# Pompe e Cilindri freno e frizione

## CLUTCH CYLINDERS, CLUTCH PUMPS AND BRAKE PUMPS

### segue POMPE FRENO

POMPE DE FREIN - BRAKE-PUMP - BREMSENpumpe - BOMBA DE FRENO

new



**OLIO MINERALE**

ARTICOLO	APPLICAZIONI	OEM
<b>16127</b>	<b>CASE:</b> Serie CX <b>MC CORMICK:</b> Serie CX	<b>CNH:</b> 226301A1

new



**OLIO MINERALE**

ARTICOLO	APPLICAZIONI	OEM
<b>16123</b>	<b>CASE:</b> JX - JXU - Luxxum <b>NH:</b> T5 - T5000 - TD4F - TD5	87354681 - 87748269 - 87748264 - 47125744 - 87398198 - 85805257 - 48151473

new



**OLIO MINERALE**

ARTICOLO	APPLICAZIONI	OEM
<b>16129</b>	8240 - 6640 - 7740 - 7840 - 5640 - 8340 - TS110 - TS100 - TS115 - TS90	<b>NEW HOLLAND:</b> 81869963

new



**OLIO MINERALE**

ARTICOLO	APPLICAZIONI	OEM
<b>16126</b>	<b>NEW HOLLAND:</b> T7.230 - T7.245 - T7.260 - T7.270	47777898

new



**OLIO DOT 4**

ARTICOLO	APPLICAZIONI	OEM
<b>16131</b>	Farmer 260S - 250S - 240S - 270P - 275P - 310 - 311 - 307 - 308 - 309 - 306 - 305 - 304	<b>FENDT:</b> G178109070110

new



**ATTENZIONE:**  
In fase di spurgo pompare  
con moderazione altrimenti si  
rovinano le valvole di chiusura.

**OLIO MINERALE**

ARTICOLO	APPLICAZIONI	OEM
<b>16146</b>	Serie 80, Serie 88, Serie 90, Serie 94	<b>FIAT:</b> 5103927

new



FIG.1



FIG.2

**ATTENZIONE:**  
Quando si sostituisce la pompa  
freno 16128 bisogna sostituire  
anche l'accumolatore 84045.

**WARNING:**  
While replacing item 16128,  
item 84045 must be replaced as  
well.

**OLIO MINERALE**

ARTICOLO	DESCRIZIONE	APPLICAZIONI	OEM	FIG.
<b>16128</b>	Pompa freno	175 - TM190	<b>NEW HOLLAND:</b> 84530032	1
<b>84045</b>	Accumolatore per 16128		<b>NEW HOLLAND:</b> 5195043	2



# Frizioni e loro componenti

CLUTCHES - CLUTCH DISK - BEARING - COUPLING - LEVER - SET-REVISION

11

## segue POMPE FRENO

POMPE DE FREIN - BRAKE-PUMP - BREMSENPUMPE - BOMBA DE FRENO



**OLIO DOT 4**

ARTICOLO	APPLICAZIONI	OEM
<b>16157</b>	Transcar 25 non sincro Transcar 25/28/33 sincro Maxter RS / SN	<b>GOLDONI:</b> 02030136 02030592



**OLIO DOT 4**

ARTICOLO	APPLICAZIONI	OEM
<b>16159</b>	Special Lux / Car Rimorchio C35/C36/C63 - 80/81	<b>GOLDONI:</b> 02030181 02030499



**OLIO DOT 4**

ARTICOLO	APPLICAZIONI	OEM
<b>16177</b>	Starcar Transcar 20 - 22 Transcar prima serie	<b>GOLDONI:</b> 02030106



**OLIO DOT 4**

ARTICOLO	APPLICAZIONI	OEM
<b>16066</b>	Serie 1000	<b>GOLDONI:</b> 02030058



**OLIO DOT 4**

ARTICOLO	APPLICAZIONI	OEM
<b>16067</b>	Serie 400 Transcar	<b>GOLDONI:</b> 02030051 02030091



**OLIO DOT 4**

ARTICOLO	APPLICAZIONI	OEM
<b>16190</b>	MTG 500/500RT MTG 700 Universalcar Rimorchio C61	<b>GOLDONI:</b> 02030026



**OLIO DOT 4**

ARTICOLO	APPLICAZIONI	OEM
<b>16191</b>	Universal Universal NUOVO	<b>GOLDONI:</b> 02030014



**OLIO DOT 4**

ARTICOLO	APPLICAZIONI	OEM
<b>16198</b>	Serie IDEA	<b>GOLDONI:</b> 02030348



**OLIO OSO 15**

ARTICOLO	APPLICAZIONI	OEM
<b>16199</b>	Cluster Rev Master Rev IDEA	<b>GOLDONI:</b> 02030353

**segue POMPE FRENO**

POMPE DE FREIN - BRAKE-PUMP - BREMSENpumPE - BOMBA DE FRENO



**OLIO DOT 4**



**OLIO DOT 4**

ARTICOLO	APPLICAZIONI	OEM
<b>16202</b>	Special Lux Transcar Sincro 635 - 636 - 663	<b>GOLDONI:</b> 02030590

ARTICOLO	APPLICAZIONI	OEM
<b>16204</b>	Aster	<b>GOLDONI:</b> 02030383

# Pompe e Cilindri freno e frizione

## CLUTCH CYLINDERS, CLUTCH PUMPS AND BRAKE PUMPS

### POMPE FRIZIONI

POMPE POUR EMBRAYAGE - CLUTCH-PUMP - KUPPLUNGSPUMPE - BOMBA PARA EMBRAGUE



**OLIO MINERALE**

ARTICOLO	APPLICAZIONI	OEM
<b>16061</b>	Dorado - Explorer - Frutteto - Golden	<b>SAME:</b> 0.010.1148.4/20



**OLIO MINERALE**

ARTICOLO	APPLICAZIONI	OEM
<b>16062</b>	Antares - Dorado - Explorer - Roller - Row Crop - Virtus J	<b>SAME:</b> 0.255.6538.4/60



**OLIO MINERALE**

ARTICOLO	APPLICAZIONI	OEM
<b>16097</b>	70/90 - 72/94 - 80/90 - 115/90 - 130/90 - 140/90 - 180/90	<b>CNH:</b> 5119606



**OLIO MINERALE**

ARTICOLO	APPLICAZIONI	OEM
<b>16098</b>	T7.140 - T7.150 - T7.165 - T7.180	<b>CNH:</b> 84570230



**OLIO MINERALE**

ARTICOLO	APPLICAZIONI	OEM
<b>16100</b>	Antares 110 - 110II - 130 - 130II - Laser 100>5001 - 1110>10001 - 115.6 - Silver 80 - 85 - 90 - 95 - 100.4 - 100.6 - 105 - 110 - 115 - 130	<b>SAME:</b> 0.008.2753.4/20

**new**



**OLIO MINERALE**

ARTICOLO	APPLICAZIONI	OEM
<b>16130</b>	F100 - F110 - F115 - F120 - F130 - F140 - M100 - M115 - M135	<b>CNH:</b> 5150299

**new**



**OLIO MINERALE**

ARTICOLO	APPLICAZIONI	OEM
<b>16138</b>	Landpower 115BLU, 125, 130BLU, 145, 160BLU, 165, 185/ Landpower IVECO TIER 3 125, 135, 165, 180 - Legend 105, 115, 130, 145, 165/ Legend N.G. 115, 120, 130, 140, 160, 180/ Legend N.G. TD1 125TDI, 130BLU, 135TD1, 145TDI, 160BLU, 165TDI, 185TDI - Mythos 100, 110, 90 / Mythos TIER 2 105, 115	<b>LANDINI:</b> 3558552M91

**new**



**OLIO MINERALE**

ARTICOLO	APPLICAZIONI	OEM
<b>16135</b>	5640, 6640, 7740, 7840, 8240, 8340 - TS100, TS110, TS115, TS90	<b>CNH:</b> 81867084



**OLIO MINERALE**

ARTICOLO	APPLICAZIONI	OEM
<b>16158</b>	Cluster RS / SN - Maxter RS / SN	<b>GOLDONI:</b> 02030375 02030591

# Pompe e Cilindri freno e frizione

## CLUTCH CYLINDERS, CLUTCH PUMPS AND BRAKE PUMPS

### CILINDRI FRIZIONI

CYLINDRE POUR EMBRAYAGE - CLUTCH-CYLINDRE - KUPPLUNGFSZILINDER - CILINDRO PARA EMBRAGUE



ARTICOLO	APPLICAZIONI	OEM
<b>16063</b>	Antares - Explorer - Laser - Row Crop - Silver - Virtus J	<b>SAME:</b> 0.255.6537.4/60



ARTICOLO	APPLICAZIONI	OEM
<b>16064</b>	Dorado - Frutteto - Golden - Roller	<b>SAME:</b> 0.007.1961.4/10



ARTICOLO	APPLICAZIONI	OEM
<b>16065</b>	Laser - Galaxi	<b>SAME:</b> 0.257.6537.4/40



ARTICOLO	APPLICAZIONI	OEM
<b>16099</b>	F100 - F110 - F115 - F130 M100 - M115 - M135 70/90 - 72/94 - 80/90 - 115/90 - 130/90 - 140/90	<b>CNH:</b> 5177914 5119605



ARTICOLO	APPLICAZIONI	OEM
<b>16124</b>	<b>VERSIONE TOP</b> Legend: 105 - 115 - 120 - 125 - 130 - 135 - 140 - 145 - 160 - 165 - 180 - 185 Landpower: 115 - 125 - 130 - 135 - 145 - 160 - 165 - 180 - 185 Mythos: 90 - 100 - 105 - 110 - 115	<b>LANDINI:</b> 3552715M91



ARTICOLO	APPLICAZIONI	OEM
<b>16139</b>	<b>VERSIONE TECHNO</b> Landpower 115BLU, 125, 130BLU, 145, 160BLU, 165, 185/ Landpower IVECO TIER 3 125, 135, 165, 180 - Legend 105, 115, 130, 145, 165/ 130 N.G. 115, 120, 130, 140, 160, 180/ 130 N.G. TDI 125TDI, 130BLU, 135TD1, 145TDI, 160BLU, 165TDI, 185TDI	<b>LANDINI:</b> 3552714M91



**OLIO DOT 4**

ARTICOLO	APPLICAZIONI	OEM
<b>16155</b>	Maxter RS Maxter SN	<b>GOLDONI:</b> 02030498 02030593



**OLIO MINERALE**

ARTICOLO	APPLICAZIONI	OEM
<b>16156</b>	Cluster RS Cluster SN Maxter RS Maxter SN	<b>GOLDONI:</b> 02030359 02030589

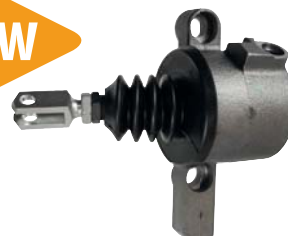

ARTICOLO	APPLICAZIONI	OEM
<b>16213</b>	<b>CASE</b> Serie JXV - JXC - JXN - Quantum - Farmall  <b>NEW HOLLAND:</b> Serie T3.XXF Serie T4.XX Serie T5.XX Serie T4000 Serie TND - TNS - TNVA - TNDA	84324333 5185842



# Pompe e Cilindri freno e frizione

## CLUTCH CYLINDERS, CLUTCH PUMPS AND BRAKE PUMPS

11

### CILINDRI FRENO

CYLINDRE POUR FREIN - BRAKE-CYLINDRE - BREMSENZILINDER - CILINDRO PARA FRENO

new



**OLIO MINERALE**

ARTICOLO	APPLICAZIONI	OEM
<b>16137</b>	Serie Legend 105-115-130-145 - Legend N.G. 115,120 130,140,160,180 TDI 125, 130, 135, 145, 160, 165, 185/Landpower 115 BLU, 125, 130BLU, 135, 145,160BLU, 165, 185 Serie Ghibli/ Serie Mythos	<b>LANDINI:</b> 3556022M91

new



**OLIO DOT 4**

ARTICOLO	APPLICAZIONI	OEM
<b>16134</b>	Serie 40, Serie 80, Frutteti Serie 530, Frutteti Serie 560, 6550, 8550, Serie Large 10000, 12500, 13000 , 14500	<b>LANDINI:</b> 3302605M91

new



**OLIO MINERALE**

ARTICOLO	APPLICAZIONI	OEM
<b>16136</b>	Globus 50-60-70-75; Legend 105-115-130-145 fino al 28/02/97 fino matr. E04059; Frutteti Serie Advantage Serie Atlas	<b>LANDINI:</b> 3537812M91

new



**OLIO DOT 4**

ARTICOLO	APPLICAZIONI	OEM
<b>16132</b>	6550, 7550, 8550, Serie Large 10000, 12500, 13000, 14500	<b>LANDINI:</b> 785625M92



**OLIO DOT 4**

ARTICOLO	APPLICAZIONI	OEM
<b>16079</b>	Starcar - Transcar - Euro sn Evo	<b>GOLDONI:</b> 00028619



**OLIO DOT 4**

ARTICOLO	APPLICAZIONI	OEM
<b>16078</b>	Serie: 400 - 500 - 700 - 800 - 1000 Transcar - Trasporter - C59 - C61	<b>GOLDONI:</b> 00005200



**OLIO DOT 4**

ARTICOLO	APPLICAZIONI	OEM
<b>16175</b>	MTG 500 Transcar Transporter Universalcar	<b>GOLDONI:</b> 00003606



**N.B.: per tamburo freno Ø250mm OLIO DOT 4**

ARTICOLO	APPLICAZIONI	OEM
<b>16180</b>	Rimorchio C35/C36/C63 Special Lux Special Car	<b>GOLDONI:</b> 0025718



**N.B.: per tamburo freno Ø220mm OLIO DOT 4**

ARTICOLO	APPLICAZIONI	OEM
<b>16181</b>	Rimorchio C35/C36/C63/80/81 Special Lux Special Car	<b>GOLDONI:</b> 00017529

### GANASCE FRENO

MÂCHOIRES DE FREIN - BRAKE SHOES - BREMSBACKEN - ZAPATAS DE FRENO



**Ganascia freno abbinata al cilindro 16079**  
**Brake shoes pared to 16079**

ARTICOLO	APPLICAZIONI	OEM
<b>16148</b>	Starcar - Transcar - Euro sn Evo	<b>GOLDONI:</b> 00028604



**Ganascia freno abbinata al cilindro 16078**  
**Brake shoes pared to 16078**

ARTICOLO	APPLICAZIONI	OEM
<b>16149</b>	Serie: 400 - 500 - 700 - 800 - 1000 Transcar - Trasporter - C59 - C61	<b>GOLDONI:</b> 00005194



**Ganascia freno 250x50 GOLDONI**

ARTICOLO	APPLICAZIONI	OEM
<b>16153</b>	Serie 500 - Special Lux - Special Car - Transcar 20/22 - Trasporter - Universalcar - C35 - C36 - C63 - 80 - 81	<b>GOLDONI:</b> 00003605



**Ganascia freno 290x60 GOLDONI**

ARTICOLO	APPLICAZIONI	OEM
<b>16154</b>	900 RS/DT Euro RS Euro RS EVO C59	<b>GOLDONI:</b> 00013854



**Tamburo freni Ø 220**

ARTICOLO	APPLICAZIONI	OEM
<b>16178</b>	Rimorchio C35/C36/C63/80/81 Special Lux Special Car	<b>GOLDONI:</b> 00017534

























**Tamburo freni Ø 220**

ARTICOLO	APPLICAZIONI	OEM
<b>16179</b>	Rimorchio C35/C36/C63/C62/ 80/81	<b>GOLDONI:</b> 00005286

# Bandelle freno





















## BRAKE BAND

# 11

MARCA E MODELLO	ARTICOLO E DESCRIZIONE	DISEGNO	OEM E MISURE	MARCA E MODELLO	ARTICOLO E DESCRIZIONE	DISEGNO	OEM E MISURE	
<b>AGRIFULL RUOTE</b>				<b>segue AGRIFULL CINGOLI</b>				
55 - 55DT - 65 - 65DT	<b>15242</b> BANDELLA INCOLLATA IN TESSUTO		OEM 5160714 Mis. 188x56x6 mm Occhiello esterno Ø 25 mm Occhiello esterno Ø 14 mm	C80.46 - C80.56 - C80.66 - C80.76 - 60C - 70C - 80C	<b>15676</b> BANDELLA INCOLLATA IN TESSUTO		OEM 5164940 Mis. 214x65x6 mm	
	<b>15487</b> BANDELLA RIVETTATA IN TESSUTO		OEM 5160714 Mis. 188x56x6 mm		<b>15247</b> BANDELLA INCOLLATA IN TESSUTO		OEM 5161638 - 5123188 - 48097881 Mis. 214x60x6 mm	
	<b>15674</b>		OEM Ceppo in tessuto per bandella 15487		<b>15490</b> BANDELLA RIVETTATA IN TESSUTO		OEM 5123188 Mis. 214x60x6 mm	
			<b>15491</b> IN CONGLOMERATO			OEM Ceppo per bandella 15490		
			<b>15703</b> IN TESSUTO			OEM Ceppo per bandella 15490		
			<b>15677</b>			OEM Ceppo in tessuto per bandella 15676		
<b>AGRIFULL CINGOLI</b>				<b>CARRARO S.P.A. - CINGOLI</b>				
C60 - C70 C70 Special	<b>15691</b> BANDELLA INCOLLATA IN TESSUTO		OEM 4965138 - 4996577 - 4965141 Mis. 214x50x6 mm	655C - 6300C	<b>15080</b> BANDELLA RIVETTATA IN TESSUTO		OEM 101169 Mis. 212x90x6 mm	
	<b>15500</b> BANDELLA RIVETTATA IN TESSUTO		OEM 4965138 - 4996577 - 4965141 Mis. 214x50x6 mm		<b>15678</b>		OEM Ceppo in tessuto per bandella 15080	
	<b>15675</b>		OEM Ceppo in tessuto per bandella 15500	450C - 450CL - 455C - 505C - 555C - 655C - 3500C - 4500C	<b>15691</b> BANDELLA INCOLLATA IN TESSUTO		OEM 86393 Mis. 214x50x6 mm	
C80.50	<b>15243</b> BANDELLA INCOLLATA IN CONGLOMERATO		OEM 5109313 Mis. 214x50x6 mm		<b>15500</b> BANDELLA RIVETTATA IN TESSUTO		OEM 86393 Mis. 214x50x6 mm	
	<b>15692</b> BANDELLA RIVETTATA IN TESSUTO		OEM 5109313 Mis. 214x50x6 mm		<b>15675</b>		OEM Ceppo in tessuto per bandella 15500	
	<b>15488</b>		OEM Ceppo in conglomerato per bandella 15489		50.5 620.5	<b>15768</b> BANDELLA RIVETTATA IN TESSUTO		OEM
	<b>15675</b>		OEM Ceppo in tessuto per bandella 15489					
C80 - 70 Special	<b>15244</b> BANDELLA INCOLLATA IN TESSUTO		OEM 5161640 Mis. 214x50x6 mm					

# Bandelle freno

## BRAKE BAND





















MARCA E MODELLO	ARTICOLO E DESCRIZIONE	DISEGNO	OEM E MISURE	MARCA E MODELLO	ARTICOLO E DESCRIZIONE	DISEGNO	OEM E MISURE
<b>FIAT RUOTE</b>				<b>segue FIAT RUOTE</b>			
La piccola - 200R - 211R - 215R - 221R - 231R - 241R - 251R - 220R -	<b>15152</b> BANDELLA RIVETTATA IN TESSUTO		OEM 5163521 582539-593868 Mis. 198x38x5 mm		<b>15493</b>		OEM 582691 Ceppo in conglomerato per bandella 15683 - 15082
250 - 300 - 300DT - 350 - 350N - 350S - 350NS - 420 - 420DT	<b>15155</b> BANDELLA INCOLLATA IN TESSUTO		OEM 5161240 Mis. 210x38x5 mm		<b>15686</b>		OEM 582691 Ceppo in tessuto per bandella 15684 - 15685
	<b>15170</b> BANDELLA INCOLLATA IN CONGLOMERATO		OEM 5161240 Mis. 210x38x5 mm	450 - 450DT - 480 - 480DT - 480 Vigneto - 500 - 500DT - 540 - 540DT - 550 - 550DT - 600 - 600DT - 640 - 640DT	<b>15239</b> BANDELLA INCOLLATA IN CONGLOMERATO		OEM 4980314-5107956 Mis. 188x50x6 Occhiello Ø 22 esterno e Ø 14 mm interno.
	<b>15680</b> BANDELLA RIVETTATA IN CONGLOMERATO		OEM 4966601-5161240 Mis. 210x38x5 mm		<b>15687</b> BANDELLA INCOLLATA IN TESSUTO		OEM 4980314-5107956 Mis. 188x50x6 Occhiello Ø 22 esterno e Ø 14 mm interno.
	<b>15681</b> BANDELLA RIVETTATA IN TESSUTO		OEM 4966601-5161240 Mis. 210x38x5 mm		<b>15083</b> BANDELLA RIVETTATA IN CONGLOMERATO		OEM 4954030-4963008 Mis. 188x50x6 Occhiello Ø 22 mm esterno e Ø 14 mm interno.
	<b>15492</b>		OEM 597871-597872 Ceppo in conglomerato per bandella 15680-15170		<b>15688</b> BANDELLA RIVETTATA IN TESSUTO		OEM 4954030-4963008 Mis. 188x50x6 Occhiello Ø 22 esterno e Ø 14 mm interno.
	<b>15682</b>		OEM 597871-597872 Ceppo in tessuto per bandella 15681-15155		<b>15494</b>		OEM 596209 Ceppo in conglomerato per bandella 15239-15083
311R - 312 - 315 - 331R - 411R-T - 415 - 431R	<b>15683</b> BANDELLA INCOLLATA IN CONGLOMERATO		OEM 582691 5161239 Mis. 176x50x6 mm		<b>15689</b>		OEM 596209 Ceppo in tessuto per bandella 15687-15688
	<b>15684</b> BANDELLA INCOLLATA IN TESSUTO		OEM 582691 5161239 Mis. 176x50x6 mm	440 - 440DT - 440 Vigneto - 450 - 450DT - 480 - 480 Vigneto - 480S - 480.8 - 480.8 DT - 480 Vigneto - 550 - 550DT - 600 - 600DT 500 - 500DT 600 - 600DT	<b>15241</b> BANDELLA INCOLLATA IN TESSUTO		OEM 4996432-5112676 Mis. 188x50x6 mm Occhiello Ø 25 mm esterno.
	<b>15082</b> BANDELLA RIVETTATA IN CONGLOMERATO		OEM 582691 5161239 Mis. 176x50x6 mm				
	<b>15685</b> BANDELLA RIVETTATA IN TESSUTO		OEM 582691 5161239 Mis. 176x50x6 mm				























# Bandelle freno

## BRAKE BAND

# 11

MARCA E MODELLO	ARTICOLO E DESCRIZIONE	DISEGNO	OEM E MISURE	MARCA E MODELLO	ARTICOLO E DESCRIZIONE	DISEGNO	OEM E MISURE
<b>segue FIAT RUOTE</b>				<b>segue FIAT CINGOLI</b>			
480S - 480.8 - 480.8DT - 480 Vigneto - 500 - 500DT - 540 - 540DT - 640 - 640DT	<b>15240</b> BANDELLA INCOLLATA IN TESSUTO		OEM 5107958 Mis. 188x56x6 mm Occhiello esterno Ø 22 mm Occhiello interno Ø 14 mm	311C - 332C - 351C - 352C - 355C - 400C - 411C - 411CL - 451C - 455C - 455C Super - 505C - 505C Super - 555C - 605C - 605C Super	<b>15248</b> BANDELLA INCOLLATA IN CONGLOMERATO		OEM 593873- 4965138-4996577 Mis. 214x50x6 mm
	<b>15242</b> BANDELLA INCOLLATA IN TESSUTO		OEM 5112685 5112686-5160714 Mis. 188x56x6 mm Occhiello esterno Ø 25 mm Occhiello interno Ø 14 mm		<b>15691</b> BANDELLA INCOLLATA IN TESSUTO		OEM 593873 - 4965138 - 4996577 - 4965141 Mis. 214x50x6 mm
	<b>15487</b> BANDELLA RIVETTATA IN TESSUTO		OEM 5107958 Mis. 188x56x6 mm		<b>15500</b> BANDELLA RIVETTATA IN TESSUTO		OEM 593873 - 4965138 - 4996577 - 4965141 Mis. 214x50x6 mm
	<b>15085</b> BANDELLA RIVETTATA IN CONGLOMERATO		OEM 5107958 Mis. 188x56x6 mm		<b>15488</b>		OEM 76028900 Ceppo in conglomerato per bandella 15248
	<b>15495</b>		OEM Ceppo in conglomerato per bandella 15085		<b>15675</b>		OEM Ceppo in tessuto per bandella 15500
	<b>15674</b>		OEM Ceppo in tessuto per bandella 15240-15487		555C - 605C - 605C Super	<b>15248</b> BANDELLA INCOLLATA IN CONGLOMERATO	
<b>FIAT CINGOLI</b>							
25C - 25CL - 25CF - 25CS - (fino al telaio N° 600600)	<b>15081</b> BANDELLA RIVETTATA IN CONGLOMERATO		OEM 536465 Mis. 198x50x6 mm	<b>15691</b> BANDELLA INCOLLATA IN TESSUTO		OEM 5109325 - 4965141 Mis. 214x50x6 mm	
	<b>15690</b> BANDELLA RIVETTATA IN TESSUTO		OEM 536465 Mis. 198x50x6 mm	<b>15500</b> BANDELLA RIVETTATA IN TESSUTO		OEM 5109325 - 4965141 Mis. 214x50x6 mm	
	<b>15496</b>		OEM Ceppo in conglomerato per bandella 15081	<b>15488</b>		OEM 76028900 Ceppo in conglomerato per bandella 15248	
	<b>15679</b>		OEM Ceppo in tessuto per bandella 15690	<b>15675</b>		OEM 76028900 Ceppo in tessuto per bandella 15500	





















MARCA E MODELLO	ARTICOLO E DESCRIZIONE	DISEGNO	OEM E MISURE	MARCA E MODELLO	ARTICOLO E DESCRIZIONE	DISEGNO	OEM E MISURE
<b>segue FIAT CINGOLI</b>				<b>segue FIAT CINGOLI</b>			
355C - 400C - 411C - 411CL - 451C - 455C - 455C Super - 505C - 505C Super - 55.65 Frutteto - 55.65 Vigneto - 55.65 Montagna - 60.65 Vigneto - 55.75 Frutteto - 55.75 Vigneto - 55.75 Montagna - 60.75 Vigneto	<b>15243</b> BANDELLA INCOLLATA IN CONGLOMERATO		OEM 5109313 Mis. 214x50x6 mm	60.65 Frutteto - 60.65 Montagna - 70.65 - 70.65 Montagna - 80.65 - 60.75 Frutteto - 60.75 Montagna - 70.75 - 70.75 Montagna - 80.75	<b>15247</b> BANDELLA INCOLLATA IN TESSUTO		OEM 5123188 5161638 - 48097881 Mis. 214x60x6 mm
	<b>15244</b> BANDELLA INCOLLATA IN TESSUTO		OEM 5109313 Mis. 214x50x6 mm		<b>15490</b> BANDELLA RIVETTATA IN TESSUTO		OEM 5123188 Mis. 214x60x6 mm
	<b>15489</b> BANDELLA RIVETTATA IN CONGLOMERATO		OEM 5109313 Mis. 214x50x6 mm		<b>15491</b> IN CONGLOMERATO		OEM Ceppo per bandella 15490
	<b>15692</b> BANDELLA RIVETTATA IN TESSUTO		OEM 5109313 Mis. 214x50x6 mm		<b>15703</b> IN TESSUTO		OEM Ceppo per bandella 15490
	<b>15488</b>		OEM Ceppo in conglomerato per bandella 15489		<b>15498</b> BANDELLA INCOLLATA IN TESSUTO		OEM 4996583-4996584 Mis. 214x56x6 mm
	<b>15675</b>		OEM Ceppo in tessuto per bandella 15692		<b>15086</b> BANDELLA RIVETTATA IN TESSUTO		OEM 4996583-4996584 Mis. 214x56x6 mm
55.65 Frutteto - 55.65 Vigneto - 55.65 Montagna - 60.65 Vigneto - 55.75 Frutteto - 55.75 Vigneto - 55.75 Montagna - 60.75 Vigneto	<b>15676</b> BANDELLA INCOLLATA IN TESSUTO		OEM Mis. 214x65x6 mm	<b>15504</b>		OEM 4996583-4996584 Ceppo in tessuto per bandella 15086	
	<b>15490</b> BANDELLA RIVETTATA IN TESSUTO		OEM Mis. 214x65x6 mm	70 - 80 - 90 - 100 - 120 1355	<b>15770</b> SERIE CEPPI		OEM Mis. 134x92x6,5 mm
	<b>15677</b>		OEM Ceppo in tessuto per bandella 15676		<b>15771</b> SERIE CEPPI MAGGIORATI 1,5		OEM Mis. 134x92x8 mm
	<b>15703</b> IN TESSUTO		OEM Ceppo in tessuto per bandella 15490	100.55 - 85.55 855 - 95.55 955	<b>15772</b> SERIE CEPPI		OEM 5161610 Mis. 122x92x6,5 mm

# Bandelle freno

## BRAKE BAND

# 11

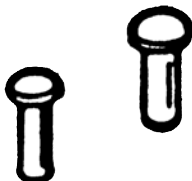
MARCA E MODELLO	ARTICOLO E DESCRIZIONE	DISEGNO	OEM E MISURE	MARCA E MODELLO	ARTICOLO E DESCRIZIONE	DISEGNO	OEM E MISURE
<b>FIAT ALLIS</b>				<b>LAMBORGHINI CINGOLI</b>			
655C 805C Mod. 5 FL 6	<b>15695</b> BANDELLA RIVETTATA IN TESSUTO		OEM Mis. 119x90x6,5 mm	C230 - C230S - C340	<b>15089</b> BANDELLA RIVETTATA IN TESSUTO		OEM 400.5005.5 Mis. 198x50x6 mm
	<b>15696</b>		OEM Ceppo in tessuto per bandella 15695		<b>15679</b>		OEM Ceppo in tessuto per bandella 15089
FA 100 FA 150 FL 7 - 8 - 9	<b>15770</b> SERIE CEPPI		OEM Mis. 134x92x6,5 mm	C483C C483S C553 Std C554 C664 C683	<b>15236</b> BANDELLA RIVETTATA IN TESSUTO		OEM 424.5411.4 Mis. 196x60x6 mm
	<b>15771</b> SERIE CEPPI MAGGIORATA 1,5		OEM Mis. 134x92x8 mm		<b>15513</b>		OEM Ceppo in tessuto per bandella 15236
FL 10 FL 14	<b>15773</b> SERIE CEPPI		OEM Mis. 171x90x6 mm	C503 - C533 - C583 - C603 - C653	<b>15499</b> BANDELLA RIVETTATA IN TESSUTO		OEM 433.5411.4 Mis. 214x50x6 mm
FD 20 FL 20 FP 60	<b>15774</b> SERIE CEPPI		OEM Mis. 153x120x8 mm		<b>15675</b>		OEM Ceppo in tessuto per bandella 15499
<b>GOLDONI - ITMA</b>				C684L / STD C704 C754 C783 C784	<b>15097</b> BANDELLA		OEM 157.5411.3/10 Mis. 210x60x6 mm
C45 3.45 3.40 Nike 280	<b>16205</b> BANDELLA FRENO		OEM 00660189 Mis. 171x40x6 mm		<b>15702</b>		OEM Serie ceppi in tessuto per bandella 15097
C60 3.60	<b>15768</b> BANDELLA RIVETTATA IN TESSUTO		OEM 00660188	<b>LANDINI CINGOLI</b>			
R230 - R230DT - R340 - R340DT	<b>15088</b> BANDELLA RIVETTATA IN TESSUTO		OEM 400.1801.3 Mis. 196x50x6 mm	C4500 C5500 C6000 CL6000 TL6C C14000 C4830F C5000STD C5830F C6030F C6500 C6830F CL5000	<b>15090</b> BANDELLA RIVETTATA IN CONGLOMERATO		OEM 1824761M91 Mis. 214x50x6 mm
	<b>15679</b>		OEM Ceppo in tessuto per bandella 15088		<b>15698</b> BANDELLA RIVETTATA IN TESSUTO		OEM 582691 Mis. 214x50x6 mm
					<b>15488</b>		OEM Ceppo in conglomerato per bandella 15090
					<b>15675</b>		OEM Ceppo in tessuto per bandella 15698
				<b>15769</b> BANDELLA RIVETTATA IN TESSUTO		OEM 3549085M91	

MARCA E MODELLO	ARTICOLO E DESCRIZIONE	DISEGNO	OEM E MISURE	MARCA E MODELLO	ARTICOLO E DESCRIZIONE	DISEGNO	OEM E MISURE									
<b>segue LANDINI CINGOLI</b>				<b>SAME RUOTE</b>												
C7800 - C7830	<b>15091</b> BANDELLA RIVETTATA IN TESSUTO		OEM 3300299M91 Mis. 121x60x6 mm	Centauro 55-60-65 - Corsaro 70 - 70 Syncro	<b>15097</b> BANDELLA RIVETTATA IN TESSUTO		OEM 157.5411.3/10 Mis. 210x60x6 mm									
	<b>15165</b>		OEM 3300302M2 Ceppo in tessuto per bandella 15091		<b>15702</b>		OEM Serie ceppi in tessuto per bandella 15097									
				Falcon - Minitauro 50-55-60 Frutteto - 60 Vigneto	<b>15095</b> BANDELLA RIVETTATA IN TESSUTO		OEM 146.5411.3/10 Mis. 178x60x6 mm									
					<b>15701</b>		OEM Serie ceppi in tessuto per bandella 15095									
<b>MASSEY FERGUSON CINGOLI</b>				Centauro 1° tipo	<b>15096</b> BANDELLA RIVETTATA IN TESSUTO		OEM 135.5411.4 Mis. 210x60x6 mm									
MF134C MF154C MF144C MF164C MF174C MF234CF MF254C MF254CF MF274C MF274CF	<b>15090</b> BANDELLA RIVETTATA IN CONGLOMERATO		OEM 1824761M91 Mis. 214x50x6 mm	<b>SAME CINGOLI</b>												
	<b>15698</b> BANDELLA RIVETTATA IN TESSUTO		OEM 1824761M91 Mis. 214x50x6 mm	Condor C Falcon C Solar 55C Solar 60C	<b>15236</b> BANDELLA RIVETTATA IN TESSUTO		OEM 424.5411.4 Mis. 196x60x6 mm									
	<b>15488</b>		OEM Ceppo in conglomerato per bandella 15090		<b>15513</b>		OEM Ceppo in tessuto per bandella 15236									
	<b>15675</b>		OEM Ceppo in tessuto per bandella 15698	Falcon C - Minitaurus 60C - Taurus C	<b>15500</b> BANDELLA RIVETTATA IN TESSUTO		OEM 160.5411.2 Mis. 214x50x6 mm									
MF194C - MF294C	<b>15091</b> BANDELLA RIVETTATA IN TESSUTO		OEM 3300299M91 Mis. 121x60x6 mm		<b>15675</b>		OEM 424.5412.0 Ceppo in tessuto per bandella 15500									
MF200C - MF244C	<b>15092</b> BANDELLA RIVETTATA IN TESSUTO		OEM 1452972M91 2739931M91 Mis. 214x60x6 mm	<b>RIVETTI PER BANDELLE</b> RIVETS ROHRNIETEN REMACHE HUECO												
	<b>15699</b>		OEM Ceppo in tessuto per bandella 15092													
MF300C	<b>15093</b> BANDELLA RIVETTATA IN TESSUTO		OEM 1432906M94 Mis. 208x75x8 mm													
				<table border="1"> <thead> <tr> <th>ARTICOLO</th> <th>DESCRIZIONE</th> <th>CONFEZIONE</th> </tr> </thead> <tbody> <tr> <td><b>15652</b></td> <td>RIVETTO 5x12 TESTA 10</td> <td>1 kg</td> </tr> <tr> <td><b>15655</b></td> <td>RIVETTO 5x15 TESTA 10</td> <td>1 kg</td> </tr> </tbody> </table>				ARTICOLO	DESCRIZIONE	CONFEZIONE	<b>15652</b>	RIVETTO 5x12 TESTA 10	1 kg	<b>15655</b>	RIVETTO 5x15 TESTA 10	1 kg
ARTICOLO	DESCRIZIONE	CONFEZIONE														
<b>15652</b>	RIVETTO 5x12 TESTA 10	1 kg														
<b>15655</b>	RIVETTO 5x15 TESTA 10	1 kg														



# Dischi e anelli freno

## DISC BRAKE PADS-BRAKE FACING

### DISCHI FRENO - ANELLI FRENO

DISQUE DE FREIN - ANNEAU DE FREIN  
DISC BRAKE PADS - BRAKE FACING  
BREMSEN SCHEIBEN - BREMSEN RING  
DISCOS FRENOS - ANILLOS FRENOS



MODELLO	ARTICOLO	DESCRIZIONE	MATERIALE	DIMENSIONI mm	OEM
<b>AGRIFULL</b>					
45 - 45DT - 50 - 50DT - 55V-F-FDT - 55 - 60 - 70 - 70DT - 70E - 70E DT - 80 - 80DT - 80E - 80E DT - 80F - 80F DT - 80.46E - 80.56 - 80.56E - 80.66 - 80.66E - 80.76 - 80.76E	<b>15132</b>	Disco freno	Sinterizzato	165x41x4,8 45x41 - Z.22	5159830
	<b>15254</b>	Disco freno	Acciaio	171,7x94,3x2,65	5119327
R235 Vigneto - R335 Vigneto - R345 - R350 Sprint - Jolly 50 - Derby 60 - Griso 70 - 80.50	<b>15257</b>	Disco freno	Conglomerato	128x70x4 40x36 - Z.20	44905820
	<b>15250</b>	Anello per disco 15257	Conglomerato		9955369
Tornado 80 - Rodeo 90 turbo - 95 turbo	<b>15462</b>	Disco freno	Conglomerato	178x101x4,8 40x36 - Z.20	44983301
	<b>15164</b>	Anello per disco 15462	Conglomerato		0012.5411.0/10
80.60 - 80.75 - 80.85 - 80.60V-F - 80.70 - 80.70F - 80.95 - 80.105	<b>15252</b>	Disco freno	Sinterizzato	261x50x10 63x50 - Z.14	4997208
	<b>15463</b>	Disco freno	Acciaio	325x175x5	5110138
90 - 90DT - 100 - 100DT - 110 - 110DT - 90E - 90E DT - 100E - 100E DT - 110E - 110E DT	<b>15253</b>	Disco freno	Sinterizzato	304x65x10 71x57 - Z.14	4993585
	<b>15466</b>	Disco freno	Acciaio	374x215x5	5110139
140 - 140 Turbo	<b>15467</b>	Disco freno	Sinterizzato	365x62x10 78x62 - Z.13	5102783
	<b>15468</b>	Disco freno	Acciaio	445x240x7	5111281
<b>BCS</b>					
Vanguard 500 - 550 - 700 - 750 - 800RS	<b>15254</b>	Disco freno	Acciaio	171,7x94,3x2,65	58171019
<b>CARRARO S.P.A.</b>					
602 - 604 - 652 - 654 - 702 - 704 - 732 - 734 - 6000 - 48.2 - 48.2FV - 48.4 - 48.4FV - 58.2 - 58.2FV - 58.4 - 58.4FV - 68.2 - 68.4 - Nuovo ok: 520.2 - 520.2V - 520.4 - 520.4V - 620.2 - 620.2F - 620.4 - 620.4F - 620.4V - 720.2 - 720.2F - 720.2V - 720.4 - 720.4F - 720.4V - 820.4V	<b>15131</b>	Disco freno	Conglomerato	152x80x4,8 48x44 - Z.23	90959
	<b>15135</b>	Anello per disco 15131	Conglomerato		65028 41381
Nuovo ok: 520.2 - 520.2V - 520.4 - 520.4V - 620.2 - 620.2F - 620.2V - 620.4 - 620.4F - 620.4V - 720.2 - 720.2F - 720.2V - 720.4 - 720.4F - 720.4V - 820.4V	<b>15132</b>	Disco freno	Sinterizzato	165x41x4,8 45x41 - Z.22	117166
	<b>15254</b>	Disco freno	Acciaio	171,7x94,3x2,65	117167
78.2 - 78.4 - 88.2 - 88.4	<b>15255</b>	Disco freno	Conglomerato	178x101x4,8 48x44 - Z.23	104822
	<b>15164</b>	Anello per disco 15255	Conglomerato		65289
<b>FIAT - NEW HOLLAND - FORD</b>					
460 - 460DT - 470 - 470DT - 470S - 470S DT - 474 - 474DT	<b>15257</b>	Disco freno	Conglomerato	128x70x4 40x36 - Z.20	44905820
	<b>15250</b>	Anello per disco 15257	Conglomerato		44902294
570 Vigneto - 570 Frutteto - 570 Frutteto DT - 570 - 570DT - 580 - 580DT - 670 - 670DT - 680 - 680DT - 670 Frutteto - 670 Frutteto DT - 780 - 780DT - 780E - 780E DT	<b>15252</b>	Disco freno	Sinterizzato	261x50x10 63x50 - Z.14	4997208
	<b>15463</b>	Disco freno	Acciaio	325x175x5	5110138
650 - 650DT - 650 Special - 715 - 750 - 750DT - 800 - 800E - 900 - 900E - 1100 - 1100E	<b>15464</b>	Disco freno	Conglomerato	230x160x6 60x55 - Z.22	5160738 44092218

# Dischi e anelli freno

## DISC BRAKE PADS-BRAKE FACING

MODELLO	ARTICOLO	DESCRIZIONE	MATERIALE	DIMENSIONI mm	OEM
<b>segue FIAT - NEW HOLLAND - FORD</b>					
366 - 366DT - 466 - 466DT - 566 - 566DT - 566E - 566E DT - 666 - 666DT - 666E - 666E DT - 766 - 766DT - 766E - 766E DT - 45.66 - 46.66DT - 46.66V DT - 50.66 - 55.66V - 55.66F DT - 55.56 - 55.56DT - 50.56 - 60.56DT - 65.56 - 65.56DT - 70.56 - 70.56DT - 55.66 - 55.66DT - 55.66LP - E-LPDT - 60.66 - 60.66DT - 60.66LP - 65.66LP - 65.66DT - 70.66LP - LPDT - 80.66F - 80.66F DT - 80.66 - 80.66DT	<b>15132</b>	Disco freno	Sinterizzato	165x41x4,8 45x41 - Z.22	5159830
	<b>15254</b>	Disco freno	Acciaio	171,7x94,3x2,65	5119327
880 - 880DT - 880/5 - 880/5DT - 980 - 980DT - 880E - 880E DT - 980 - 980E DT - 90.90 - 90.90DT - 100.90 - 100.90DT - 110.90 - 110.90DT	<b>15253</b>	Disco freno	Sinterizzato	304x65x10 71x57 - Z.14	4993585
	<b>15466</b>	Disco freno	Acciaio	374x215x5	5110139
1180 - 1180DT - 1280 - 1280DT - 1380 - 1380DT - 1580 - 1580DT - 1580DT Turbo - 1880 - 1880DT - 115.90 - 115.90DT - 130.90 Turbo - 130.90DT Turbo - 140.90 Turbo - 140.90 DT Turbo - 160.90 Turbo - 160.90DT Turbo - 180.90 Turbo - 180.90DT Turbo	<b>15467</b>	Disco freno	Sinterizzato	365x62x10 78x62 - Z.13	5102783
	<b>15468</b>	Disco freno	Acciaio	445x240x7	5111281
100/90 - 70/66S - 80/66S - TD5040 - TD55D - TD60D - TD65D - TD70D - TD75D - TD80D - TD90D - TD95D	<b>15810</b>	Disco freno	Acciaio	152x100x1,50 Z.6	5163840 84177629
70/90DT - 90/90DT - 80/66DT - 80/90DT - 80/88DT - 85/90DT - 70/88DT - 70/66DT - 70/66SDT - 80/66SDT - 100/90 - 100/90DT - 110/90DT - 110/90 - TD5.105 - TD5.95 - TD5.115 - TD5050 - TD5030 - TD5040 - TD55D - TD75D - TD55D - TD60D - TD65D - TD70D - TD90D - TD75D - TD80D - TD80D PLUS - TD85D - TD95D - TD90D - TD95D - TD95D PLUS	<b>15819</b>	Disco freno	Sinterizzato	140x91x2 Z.32	47033066 5140243
8160 - 8260 - 8360 - 8560 - F100 - F110 - F115 - F120 - F130 - F140 - M100 - M115 - M135 - M160 - TM115 - TM125 - TM135 - TM150 - TM165	<b>15820</b>	Disco freno	Sinterizzato	327x60x10 76x60 - Z.14	5154521

### GOLDONI

3000 - STAR 3000 - COMPACT - QUASAR - STAR 4000 Q - STAR 50/70 - STAR QUADRIFOGLIO	<b>16029</b>	Disco freno	Sinterizzato	165x110x5 40x36 - Z.20	00041480 00043325 00064139
	<b>15254</b>	Disco freno	Acciaio	171,7x94,3x2,65	00018017
ASTER - RONIN CLUSTER RS/SN/REVERSIBILE MAXTER RS/SN/REVERSIBILE	<b>16183</b>	Disco freno	Sinterizzato	143x90x5,0 - Z.18	00033594
	<b>16184</b>	Disco freno	Acciaio	-	00040974
BOXTER IDEA IDEA 35-37-40 - HST	<b>15251</b>	Disco freno	Sinterizzato	101x28x5,2 30x28 - Z.23	00025834
	<b>16188</b>	Disco freno	Acciaio	108x50x2,65 2 tacche esterne	00028021

# Dischi e anelli freno

## DISC BRAKE PADS-BRAKE FACING

11

MODELLO	ARTICOLO	DESCRIZIONE	MATERIALE	DIMENSIONI mm	OEM
<b>HURLIMANN</b>					
H-345 - H-355 - H-360 - H-470	<b>15255</b>	Disco freno	Conglomerato	178x101x4,8 48x44 - Z.23	17754343
	<b>15164</b>	Anello per disco 15255	Conglomerato	-	13654350
4351	<b>15251</b>	Disco freno	Sinterizzato	101x28x5,2 30x28 - Z.23	15154690
	<b>15469</b>	Disco freno	Acciaio	108x50x2,7	15154680
H-351 - H-355F - H-360 - H-361 - H-361F - H-361V - H-470 - H-476F	<b>15470</b>	Disco freno	Sinterizzato	178x44x5 48x44 - Z.23	25654340
	<b>15471</b>	Disco freno	Acciaio	184x114x2,65	17754750
H5160 - H6160 (Fino al Tel. N° 00161)	<b>15476</b>	Disco freno	Sinterizzato	224x55x4,8 60x55 - Z.27	15454590
	<b>15130</b>	Disco freno	Acciaio	228x127x2,65	15454600
<b>LAMBORGHINI</b>					
R483 - 483DT - R503 - 503DT - R603 - 603DT - R583 - 583DT - R653 - 653DT - R654 - 654DT	<b>15255</b>	Disco freno	Conglomerato	178x101x4,8 48x44 - Z.23	17754343
	<b>15164</b>	Anello per disco 15255	Conglomerato	-	13654350
R483 - 483DT - R550 - 550DT - R583 - 583DT - R653 - 653DT - R654 - 654DT - 653 Frutteto - R683 - 683DT - R684 - 684DT - R684DT Frutteto - R724 - 724DT - 660 - 660DT - 660F - 660V - 775	<b>15470</b>	Disco freno	Sinterizzato	178x44x5 48x44 - Z.23	25654340/10
	<b>15471</b>	Disco freno	Acciaio	184x114x2,65	25654560
R480 - 480DT - R485 - 485DT - R490 - R704 - R704DT - R804 - 804DT - R904 - 904DT	<b>15472</b>	Disco freno	Sinterizzato	224x53x4,8 60x53 - Z.22	42754340
	<b>15473</b>	Disco freno	Acciaio	228x127x2,65	15454600/10
R235 - R235DT - R235S	<b>15133</b>	Disco freno	Conglomerato	102x51x4,5 31x28,5 - Z.23	15954343
	<b>15479</b>	Anello per disco 15133	Conglomerato	-	15954350
R240 - 240DT - R350 - 350DT - R503 - 503DT - R603 - 603DT	<b>15131</b>	Disco freno	Conglomerato	152x80x4,8 48x44 - Z.23	42254343
	<b>15135</b>	Anello per disco 15131	Conglomerato	-	42254350
R345 - R345DT - R345F	<b>15251</b>	Disco freno	Sinterizzato	101x28x5,2 30x28 - Z.23	15154690
	<b>15469</b>	Disco freno	Acciaio	108x50x2,7	15154680
<b>LANDINI</b>					
R3200 - R5000 - R5000 Special - R5000 MKz - R6000 Special MK3 - 6000DT	<b>15474</b>	Disco freno	Conglomerato	143x85x4,8 41,5x36 - Z.10	1432328M91
	<b>15249</b>	Anello per disco 15474	Conglomerato	-	1422434M91
R5500 - R6500 - R6550 - R6550/4 - R6550 Velox Drive - R7500 - R7550 - R8500DT	<b>15475</b>	Disco freno	Conglomerato	165x85x4,8 45x38 - Z.13	1823112M91
	<b>15134</b>	Anello per disco 15475	Conglomerato	-	1423617M91 3305272M91
R10000DT - 10000S - 10000MKz - R12000DT - 12500 - 13000 - 13000MKz (dal 11-87) - 14500 Turbo - 14500 MKz (dal 11-87)	<b>15476</b>	Disco freno	Sinterizzato	224x55x4,8 60x55 - Z.27	1860964M2
	<b>15130</b>	Disco freno	Acciaio	228x127x2,65	1860965M2
R8550DT - R8550DT Velox Drive - 5530F-F. DT - 5530L-V - 6530F-F.DT - 6530L-V - 6030L Turbo - 6030F Turbo - 6030V Turbo	<b>15477</b>	Disco freno	Conglomerato	178x101x4,8 45x38 - Z.13	3302699M91
	<b>15164</b>	Anello per disco 15477	Conglomerato	-	1895853M91
R8000 - R8000 Special - R9000 Special	<b>15478</b>	Disco freno	Conglomerato	178x101x4,8 59x55 - Z.27	1753117M91
	<b>15164</b>	Anello per disco 15478	Conglomerato	-	1845853M91 840916M92
65/75/85 GT-F - 5530F/FDT/L/V - 6530F/ FDT/L/V - 6030L/F/V TURBO - 7530L - 8530F/L - R-DT: 5860-5870-6060-6070- 6680-6860-6870-7830-7860-7870-4880- 8830-8860-8870-8880-9880 ADVANTAGE: L55/60/65/75/85 FP-LP BLIZZARD: L50/60/65/75/85/95 GLOBE - GHIBLI - GLOBALFARM - MULTIFARM - POWERFARM - POWERMONDIAL - REX - Serie 4D/5H - TREKKER - VISION	<b>15875</b>	Disco freno	Acciaio - Carta	178x140x4,8 48x44 - Z.23	3671530M2 3550896M1 3308295M2
	<b>16122</b>	Disco freno Maggiorato	Grafitico		
	<b>15471</b>	Disco freno	Acciaio	184x114x2,65	3308296M2

# Dischi e anelli freno

## DISC BRAKE PADS-BRAKE FACING

MODELLO	ARTICOLO	DESCRIZIONE	MATERIALE	DIMENSIONI mm	OEM
<b>MASSEY FERGUSON</b>					
MF135 - 148 - 152 - MF765 - MF1104	<b>15478</b>	Disco freno	Conglomerato	178x101x4,8 59x55 - Z.27	1753117M91
	<b>15164</b>	Anello per disco 15478	Conglomerato		840916M92
MF133 MK3 - 135 MK3 Francia - Export - 148 MK3 - MF165 - 168 - 175 - 178 - 185 - 188 - 235 - 245 - 265 - 250 - 260 - 290 (Europa) - 255 - 275 - 285 - 290 - 298 (Francia) - 350 - 355 - 365 - 353 - 363 - 373 - 375 - 390 - 398 - 399 - 550 - 560 - 565 - 575 - 590 - 595 - 595 MK2 - 675 - 675/4 - 690 - 690/4 - 698 - 698/4 - 699 - 699/4 - 1080 - 1080.8 - 1080.8 Super - 1014 - 1024 - 1114 - 1124 - 1134	<b>15476</b>	Disco freno	Sinterizzato	224x55x4,8 60x55 - Z.27	1860964M2
	<b>15130</b>	Disco freno	Acciaio	228x127x2,65	1860965M2
MF134 - 134S/4 - 154S/4 - 174 - 174S - MF184 - 194 - 233 - 253 - 263 - 273 - MF254 - 264 Turbo - 274 (fino al tel. 2211008) - MF284S - 284/4S - 294S (fino al tel. 126000657)	<b>15475</b>	Disco freno	Conglomerato	165x85x4,8 45x38 - Z.13	1823112M91
	<b>15134</b>	Anello per disco 15475	Conglomerato		1423617M91
254 - 264 Turbo - 274 (dal tel. 22111009) - 284S - 284/4S - 294S (dal tel. 126C00658)	<b>15477</b>	Disco freno	Conglomerato	178x101x4,8 45x38 - Z.13	3302699M91
	<b>15164</b>	Anello per disco 15477	Conglomerato		3303240M91
MF765 - 1104 - Sirenetta	<b>15478</b>	Disco freno	Conglomerato	178x101x4,8 59x55 - Z.27	1753117M91
	<b>15164</b>	Anello per disco 15478	Conglomerato		840916M91
<b>SAME</b>					
Aurora 35-45 - Vigneron 35-45	<b>15133</b>	Disco freno	Conglomerato	102x51x4,5 31x28,5 - Z.23	15954343
	<b>15479</b>	Anello per disco 15133	Conglomerato		15954350
Centurion 75 Export - Condro 55 synchro - Corsaro 70 - Corsaro 70 synchro - Corsaro frutteto - Minitaurus 60 synchro - Saturno - Saturno 80 synchro - Taurus 60 Export - Vigneron 60-62	<b>15477</b>	Disco freno	Conglomerato	178x101x4,8 45x38 - Z.13	15854343
	<b>15164</b>	Anello per disco 15477			13654350
Centauro 70 Export - Centauro 70 Special - Centurion 75 Special - Galaxy 170 Turbo - Hercules 160 Export (dal Tel. 1241) - Mercury 85 Special	<b>15480</b>	Disco freno	Sinterizzato	224x55x4,8	15454590/10
	<b>15473</b>	Disco freno	Acciaio	228x127x2,63	15454600/10
Delfino 32-35 - Ranger 45 - 45 Frutteto - Vigneron 50	<b>15251</b>	Disco freno	Sinterizzato	101x28x5,2 30x28 - Z.23	15154690
	<b>15469</b>	Disco freno	Acciaio	108x50x2,7	15154680
Drago 100 - 120 - Hercules 160 Export (fino al Tel. 1240) - Panther 95	<b>15480</b>	Disco freno	Sinterizzato	224x55x4,4 60x55 - Z.27	15454590
	<b>15130</b>	Disco freno	Acciaio	228x127x2,65	15454600
Frutteto 60-75 - Solar 50	<b>15470</b>	Disco freno	Sinterizzato	178x44x5 48x44 - Z.23	25654340/10
	<b>15471</b>	Disco freno	Acciaio	196,6x183,7x2,65	25654560
Centauro 55 - 60 - 65 Corsaro 70	<b>15775</b>	Disco freno	Sinterizzato	224x154x4,8 60x45 - Z.22	13554343
Leopard 80-90 - Tiger 100 Titan 145-160-190 - Trident 130	<b>15818</b>	Disco freno	Sinterizzato	304x51x10 68x50 - Z.12	17054340/12



# Dischi frizioni idrauliche

## HYDRAULIC CLUTCH DISCS

11

### INNESTO DELLA TRASMISSIONE A 4 RUOTE MOTTRICI - FRIZIONE

ENGAGEMENT DE LA TRANSMISSION 4 ROUES MOTRICES - EMBRAYAGE

4WD POWER TRANSMISSION - CLUTCH

4WD GETRIEBE - KUPPLUNG

4WD TRANSMISSION - EMBRAGUE

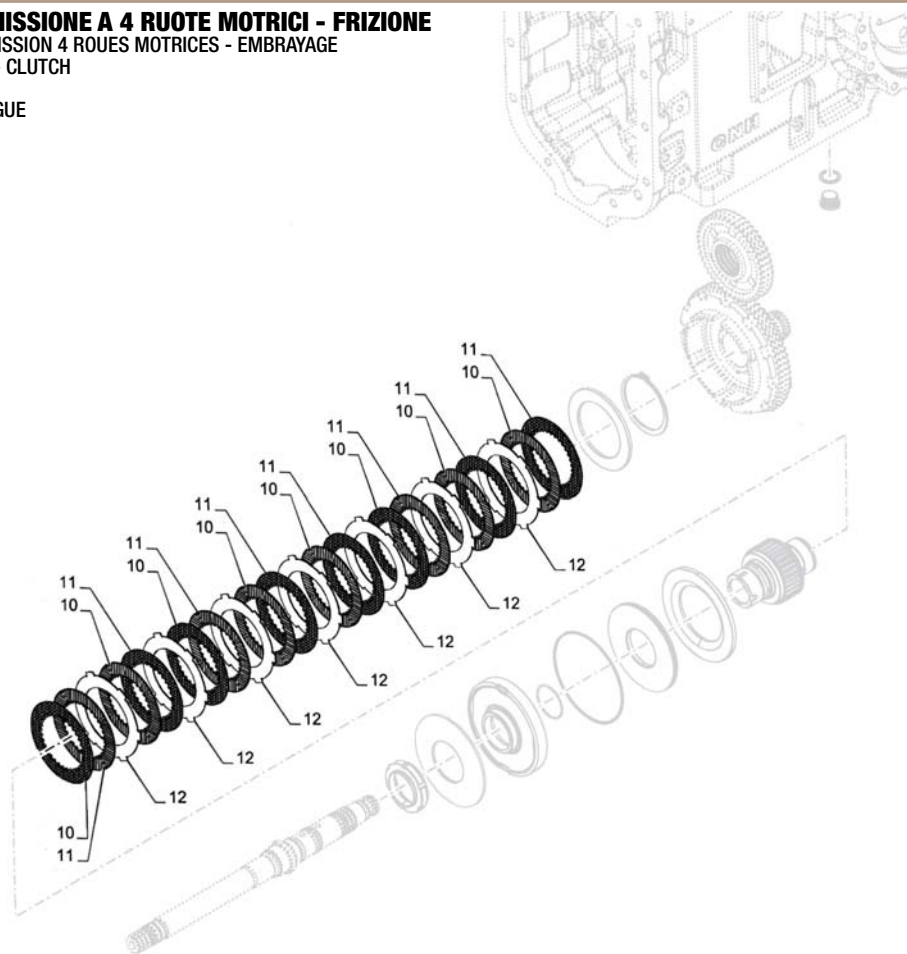

ARTICOLO	MATERIALE	DIMENSIONI mm	OEM	APPLICAZIONI	RIF.
<b>15817</b>	Carta	140x91x1,80 - Z.32	5163844 - 5163904	<b>NEW HOLLAND</b>	10
<b>15821</b>	Carta	140x91x1 - Z.32	5159755	Serie T6: .120 / .125 / .145 / .150 / .160 / .175 / .180	11
<b>15811</b>	Acciaio	152x100x1,50 - Z.50	5143721	Serie T6000: T6010 - T6020 - T6030 - T6040 - T6050 - T6060 - T6070	12

### FRIZIONE A COMANDO IDRAULICO PER INNESTO DOPPIA TRAZIONE (4WD)

EMBAYAGE HYDRAULIQUE POUR ENGAGEMENT DOUBLE TRACTION (4WD)

4WD HYDRAULIC CLUTCH

4WD HYDRAULISCHE KUPPLUNG

4WD EMBRAGUE HIDRÁULICO

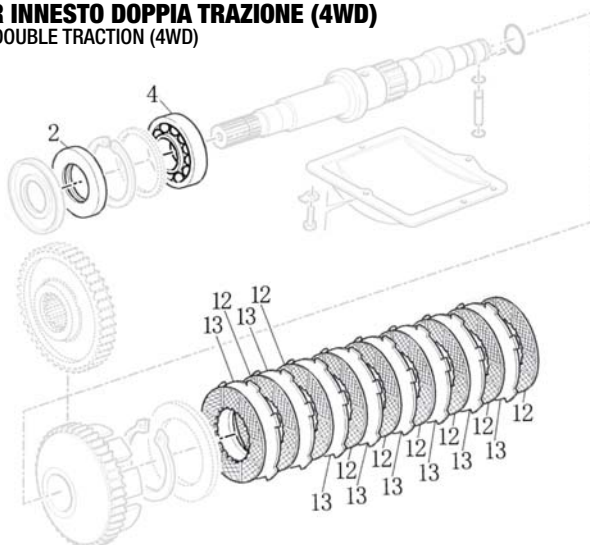

ARTICOLO	MATERIALE	DIMENSIONI mm	OEM	APPLICAZIONI	RIF.
<b>15817</b>	Carta	140x91x1,80 - Z.32	5163904	<b>NEW HOLLAND</b>	12
<b>15810</b>	Acciaio	152x100x1,50 - Z.6	5163840	Serie TM: TM115 - TM120 - TM125 - TM130 - TM140 - TM150 - TM155 - TM165 - TM175	13
<b>64432</b>	-	40x80x12	5125897	Serie 60: 8160 - 8260 - 8360 - 8560	2
<b>62931</b>	-	40x80x19,75	26799960		4

# Dischi frizioni idrauliche

## HYDRAULIC CLUTCH DISCS

### FRIZIONE PRESA DI FORZA

EMBRAYAGE DE PRISE DE FORCE  
P.T.O. CLUTCH DISK  
ZAPFWELLESKUPPLUNG  
EMBRAGUE DE TOMA DE FUERZA

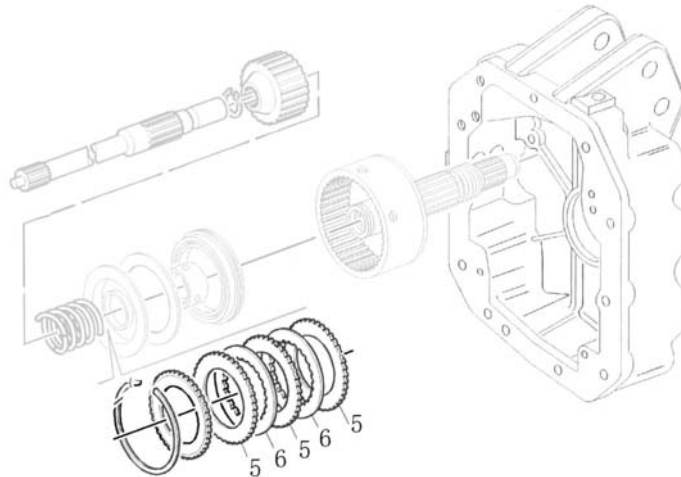

ARTICOLO	MATERIALE	DIMENSIONI mm	OEM	APPLICAZIONI	RIF.
<b>15811</b>	Acciaio	152x100x1,50 - Z.50	5143721	<b>NEW HOLLAND</b> Serie 60: 8160 - 8260 - 8360 - 8560	5
<b>15816</b>	Carta	140x91x2,5 - Z.32	5158919	Serie M: M100 - M115 - M135 - M160 Serie F: F100 - F115 - F130 - F140	6

### BLOCCAGGIO DIFFERENZIALE PER ASSE RUOTA RINFORZATO - RUOTISMI RINVIO (4WD)

BLOCAGE DE DIFFÉRENTIEL RENFORCÉ - (4WD)  
REINFORCED DIFFERENTIAL LOCK - (4WD)  
VERSTÄERKTE DIFFERENTIALSPERRE - (4WD)  
BLOQUEO DIFERENCIAL REFORZADO - (4WD)

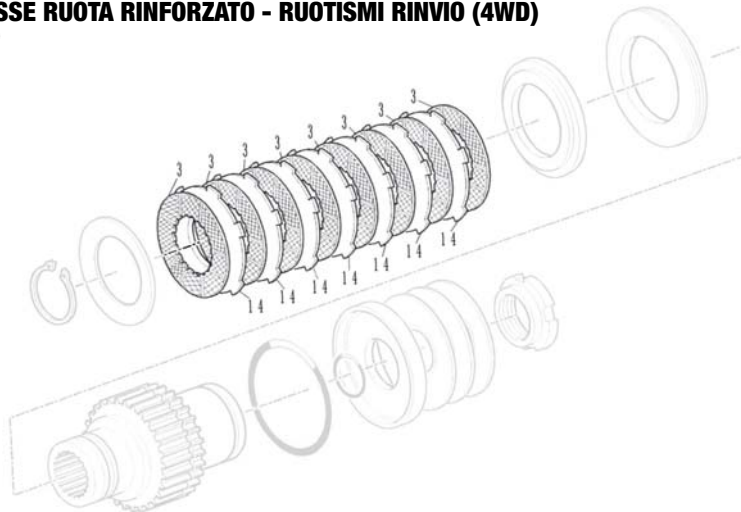

ARTICOLO	MATERIALE	DIMENSIONI mm	OEM	APPLICAZIONI	RIF.
<b>15817</b>	Carta	140x91x1,80 - Z.32	5163904	<b>NEW HOLLAND</b> Serie TSA: TS100A - TS110A - TS115A - TS125A - TS135A	3
<b>15810</b>	Acciaio	152x100x1,50 - Z.6	5163840 - 84177629		14

### ALLESTIMENTO CAMBIO HI-LO

ÉQUIPEMENT DE BOÎTE DE VITESSE  
HI-LO GEARBOX EQUIPMENT  
HI-LO GETRIEBE  
CAJA DE CAMBIO HI-LO

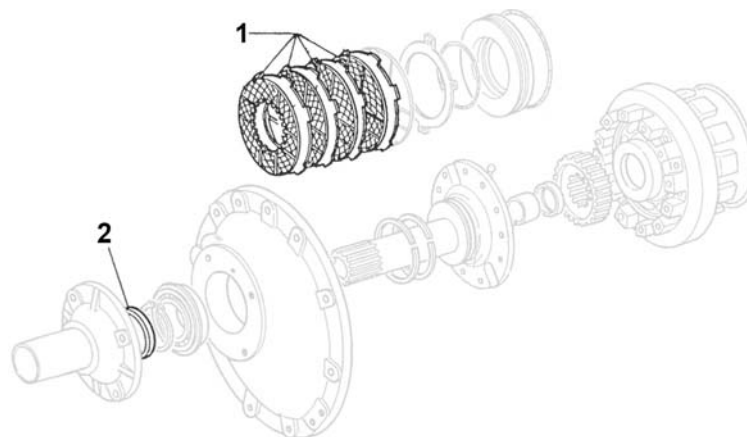

ARTICOLO	MATERIALE	DIMENSIONI mm	OEM	APPLICAZIONI	RIF.
<b>15821</b>	Carta	140x91x1 - Z.32	5159755 - 5143863	<b>FIAT</b> Serie F: F100 - F110 - F120 - F130	1
<b>65157</b>	-	55x70x8	5112307		2

Gli articoli qui descritti, prodotti da e/o per conto di CERMAG, sono da intendersi adattabili, quindi non originali, ai marchi indicati secondo REG. CE 1400/2002  
All items described here, produced by and/or on behalf of CERMAG, are to be understood as adaptable, therefore not original, to the brands indicated according to REG. EC 1400/2002

# Attuatori freno

## BRAKE ACTUATOR

11



**ATTUATORE 4"**  
ACTIONNEUR 4"  
4" ACTUATOR  
AKTUATOR 4"  
ACTUADOR 4"

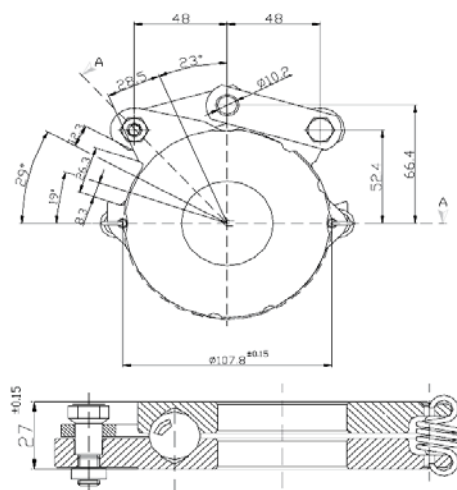

**ATTUATORE 6,5"**  
ACTIONNEUR 6,5"  
6.5" ACTUATOR  
AKTUATOR 6,5"  
ACTUADOR 6,5"

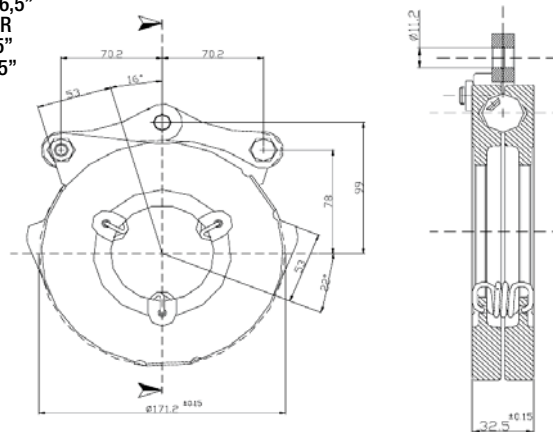

ARTICOLO	DESCRIZIONE	APPLICAZIONE	OEM
<b>15781</b>	Funzionamento a secco	SAME	159.5432.3

ARTICOLO	DESCRIZIONE	APPLICAZIONE	OEM
<b>15777</b>	Funzionamento bagno d'olio	FIAT	5129473
<b>15778</b>	Funzionamento a secco	LANDINI - MF	1822606M92

**ATTUATORE 7"**  
ACTIONNEUR 7"  
7" ACTUATOR  
AKTUATOR 7"  
ACTUADOR 7"

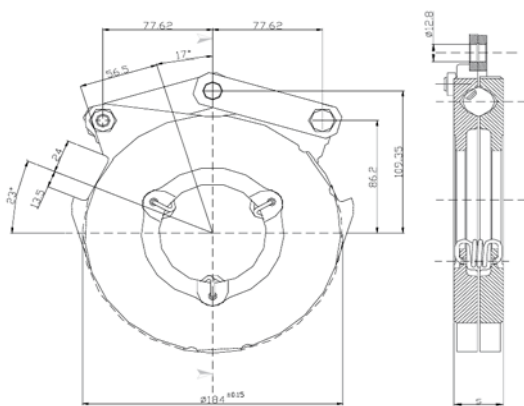

**ATTUATORE 7"**  
ACTIONNEUR 7"  
7" ACTUATOR  
AKTUATOR 7"  
ACTUADOR 7"

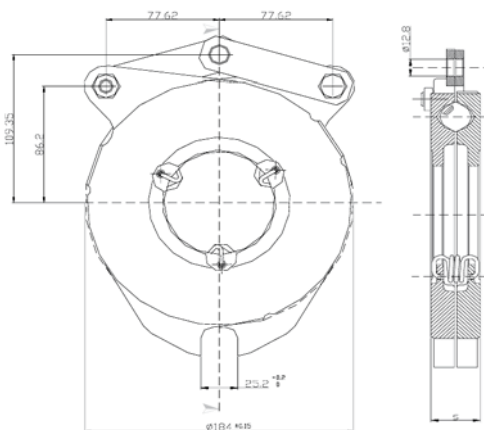

ARTICOLO	DESCRIZIONE	APPLICAZIONE	OEM
<b>15779</b>	Funzionamento a secco	LANDINI - MF	1895334M91

ARTICOLO	DESCRIZIONE	APPLICAZIONE	OEM
<b>15780</b>	Funzionamento bagno d'olio	LANDINI - MF	3308792M91

# Placchette sinterizzate e pastiglie freno

SINTERED PLATES - BRAKE PADS

## PLACCHETTE SINTERIZZATE

PLAQUETTES - BUTTONS - GESINTERT PLAETTCHEN - PASTILLE SINTERIZATE

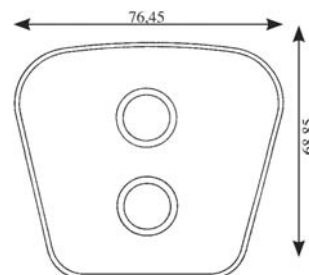
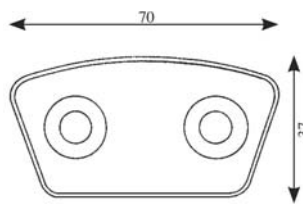
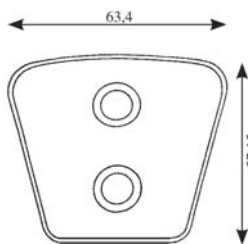

ARTICOLO	SPESSORE	NOTE
<b>15448</b>	3,60 mm	Le placchette sono fornite complete di rivetti.
<b>15449</b>	4,00 mm	

ARTICOLO	SPESSORE	NOTE
<b>15450</b>	3,60 mm	Le placchette sono fornite complete di rivetti.
<b>15451</b>	4,00 mm	

ARTICOLO	SPESSORE	NOTE
<b>15452</b>	3,60 mm	Le placchette sono fornite complete di rivetti.
<b>15453</b>	4,00 mm	
<b>15454</b>	4,80 mm	

## PASTIGLIE FRENI DI STAZIONAMENTO

PLAQUETTE DE FREIN  
BRAKES HANDS  
STANDBREMSE BELAGEN  
PASTILLAS FRENO DE ESTACIONAMENTO



ARTICOLO	MATERIALE	OEM	APPLICAZIONI
<b>15264</b>	Sinterizzato (Ferodo da 1 lato)	5104773	AGRIFULL: 80.60 - 80.75 - 80.85 - 80.60V-F - 80.70 - 80.70F - 90 - 90DT - 100 - 100DT - 110 - 110DT - 90E - 90E DT - 100E - 100E DT - 110E - 110E DT - 140 - 140DT Turbo - 80.95 - 80.105.
<b>15813</b>	Carta (Ferodo da 1 lato)	5158120	FIAT: 570 Vigneto - Frutteto - Frutteto DT - 570 - 570DT - 580 - 580DT - 670 - 670DT - 680 - 680DT - 670 Frutteto - Frutteto DT - 780 - 780DT - 880 - 880DT - 880/5 - 880/5DT - 980 - 980DT - 1180 - 1180DT - 1280 - 1280DT - 1380 - 1380DT - 1580 - 1580DT - 1580DT Turbo - 1880 - 1880DT - 780E - 780E DT - 800E - 800E DT - 980E DT - 90.90 - 90.90DT - 100.90 - 100.90DT - 110.90 - 110.90DT - 115.90 - 115.90DT - 130.90 Turbo - 130.90DT Turbo - 140.90 Turbo - 140.90DT Turbo - 160.90 Turbo - 160.90DT Turbo - 180.90 Turbo - 180.90DT Turbo.
<b>15265</b>	Sinterizzato (Ferodo da 2 lati)	5104774	AGRIFULL: 70 - 70DT - 70E - 70E DT - 80 - 80DT - 80E - 80E DT - 80F - 80F DT - 80.46F - 80.56 - 80.56E - 80.66 - 80.66E - 80.76E - 80.76E.  FIAT: 366 - 366DT - 466 - 466DT - 566 - 566DT - 566E - 566E DT - 666 - 666DT - 666E - 666E DT - 766 - 766DT - 766E - 766E DT - 55.90 - 55.90DT - 60.90 - 60.90DT - 65.90 - 65.90DT - 70.90 - 70.90DT - 80.90 - 80.90DT - 55.56 - 55.56DT - 60.56 - 60.56DT - 65.56 - 65.56DT - 70.56 - 70.56DT - 55.66 - 55.66DT - 55.66LP - 60.66 - 60.66DT - 60.66LP - 65.66DT - 70.66LP - 70.66LP DT - 80.66F - 80.66F DT - 80 - 66 - 80 - 66DT.
<b>15812</b>	Carta (Ferodo da 2 lati)	5105817 5158123 5105815	
<b>15481</b>	Sinterizzato	5118095	
<b>15482</b>	Sinterizzato	5118100	HURLIMANN: H335 - H356 - H358 - H358.4 - H358 Prestige - H360 - H362 - H372 - H466 - H466.4 - H468 - H468.4 - H468.4 Prestige - H470 - H476 - H476.4 - H478 - H478.4 - H478T Prestige - H488T Prestige - H480 - H486T - H488T - H496T - H5110 - H5160 - H6160 - H6136. LAMBORGHINI: R573.60N - R574.60N - R674 - R674.5 - R674.70N - R674.70 Gran Prix - R684 - R684DT - R684DT Frutteto - R724 - R724DT - R754 - R754DT - R784 - R784DT - R854 - R854DT - R774 - R774DT - R955 - R955DT - R956 - R956.100 - R1106 - R1106DT - R1056 - R1156 - R1256 - R1306 Turbo DT - R1356DT - R1506 Turbo DT - R1556DT - 600 - 700 Turbo - 774.5 - 774.80 - 774.80N - 774.80 Gran Prix - 874 Turbo - 874.90 T Gran Prix. SAME: Aster 60-70 - Explorer 55-60-60 II <sup>a</sup> - 60 Special - 65-65 Special - 70 II <sup>a</sup> - 70 Special - 75-80 II <sup>a</sup> - 80 Special - 90 II <sup>a</sup> Turbo - Jaguar 95 Export - Laser 90 - 100 - 110 - Leopard 90 Turbo - Tiger 100 - Tiger SIX 105 Export - Trident 130 Export.
<b>15483</b>	Sinterizzato	171.5451.2	
<b>15484</b>	Sinterizzato	171.5459.2	LANDINI: R10000 DT - 10000 S - 10000 MK2 - R12000 DT - R12500 - 13000 - 13000 MK2 (dal 11/87) - R14500 Turbo - 14500 MK2 (dal 11/87) - R5530 F - F. DT - 5530 L - V - 6530 F - F. DT - R 6530 L - V - 6030 L Turbo - F Turbo - V Turbo - R5830 DT - R6830 DT - R7530 F - F DT - 7530 L - R8530 F - L - R7830 DT - R8830 DT.
<b>15485</b>	Sinterizzato	3302.353.M1	
<b>15486</b>	Sinterizzato	3302.354.M1	LAVERDA: 3350 - AM1200 - M100 - M1000AL - M112 - M120 - M130 - M150 - M152 - TA150
<b>15776</b>	Sinterizzato	3.000.18384 3.209.65550	